



User Manual

RSB-4680

**RISC-Based 3.5" SBC with
ROCKCHIP ARM® Cortex®-A17
RK3288 Quad Core Processor**

ADVANTECH

Enabling an Intelligent Planet

Copyright

The documentation and the software included with this product are copyrighted 2018 by Advantech Co., Ltd. All rights are reserved. Advantech Co., Ltd. reserves the right to make improvements in the products described in this manual at any time without notice. No part of this manual may be reproduced, copied, translated or transmitted in any form or by any means without the prior written permission of Advantech Co., Ltd. Information provided in this manual is intended to be accurate and reliable. However, Advantech Co., Ltd. assumes no responsibility for its use, nor for any infringements of the rights of third parties, which may result from its use.

Acknowledgements

ARM is a trademark of ARM Corporation

ROCKCHIP is a trademark of ROCKCHIP Corporation

All other product names or trademarks are properties of their respective owners

Product Warranty (2 years)

Advantech warrants to you, the original purchaser, that each of its products will be free from defects in materials and workmanship for two years from the date of purchase.

This warranty does not apply to any products which have been repaired or altered by persons other than repair personnel authorized by Advantech, or which have been subject to misuse, abuse, accident or improper installation. Advantech assumes no liability under the terms of this warranty as a consequence of such events.

Because of Advantech's high quality-control standards and rigorous testing, most of our customers never need to use our repair service. If an Advantech product is defective, it will be repaired or replaced at no charge during the warranty period. For out-of-warranty repairs, you will be billed according to the cost of replacement materials, service time and freight. Please consult your dealer for more details.

If you think you have a defective product, follow these steps:

1. Collect all the information about the problem encountered. (For example, CPU speed, Advantech products used, other hardware and software used, etc.) Note anything abnormal and list any onscreen messages you get when the problem occurs.
2. Call your dealer and describe the problem. Please have your manual, product, and any helpful information readily available.
3. If your product is diagnosed as defective, obtain an RMA (return merchandise authorization) number from your dealer. This allows us to process your return more quickly.
4. Carefully pack the defective product, a fully-completed Repair and Replacement Order Card and a photocopy proof of purchase date (such as your sales receipt) in a shippable container. A product returned without proof of the purchase date is not eligible for warranty service.
5. Write the RMA number visibly on the outside of the package and ship it prepaid to your dealer.

Declaration of Conformity

FCC Class B

Note: This equipment has been tested and found to comply with the limits for a Class B digital device, pursuant to part 15 of the FCC Rules. These limits are designed to provide reasonable protection against harmful interference in a residential installation. This equipment generates, uses and can radiate radio frequency energy and, if not installed and used in accordance with the instructions, may cause harmful interference to radio communications. However, there is no guarantee that interference will not occur in a particular installation. If this equipment does cause harmful interference to radio or television reception, which can be determined by turning the equipment off and on, the user is encouraged to try to correct the interference by one or more of the following measures:

- Reorient or relocate the receiving antenna
- Increase the separation between the equipment and receiver
- Connect the equipment into an outlet on a circuit different from that to which the receiver is connected
- Consult the dealer or an experienced radio/TV technician for help

Ordering Information

| Part No. | Description |
|------------------|---|
| RSB-4680CQ-XNA1E | RSB-4680 3.5" SBC ROCKCHIP RK3288 Quad 1.6GHz |

Packing List

Before installation, please ensure the following items have been shipped.

- 1 x RSB-4680 3.5" motherboard
- 1 x China RoHS

Optional Accessories

| Part No. | Description |
|--------------------|---|
| 96PSA-A60W12W6 | ADP A/D 100-240V 60W 12V C14 LOCKABLE DC PLUG |
| 1702002605 | Power Cord 3P EU 10A 250V 183cm |
| 1702031801 | Power Cord 3P UK 10A 250V 183cm |
| 1702002600 | Power Cord UL 3P 10A 125V 183cm |
| 1700009652 | Power Cord CCC 3P 10A 250V 187cm |
| 1700021565-01 | Debug Cable |
| IDK-1107WR-40WVA1E | 7" LED PANEL 400N with 4WR Touch, 800 x 480 (G) |
| 1700028571-01 | LVDS Cable for IDK-1107WR |
| 1700028572-01 | LCD Black Light Cable for IDK-1107WR |
| SQF-MSDM1-8G-21C | SQF MICRO SD C10 MLC 8G (-25 ~ 85 °C) |
| EWM-W167M201E | WIFI /BT4.0 Module RTL8723BS SDIO |
| 1750007965-01 | Antenna Cable R/P SMA (M) to MHF4, 300mm |
| 1750008671-01 | Dipole Ant.SMA/M-R 2.4/5G 2.5/4dBi BLK 109mm |
| 968AD00081 | Qucetel EC20CEFA Mini-PCle 4G Module |
| 1750006264 | Antenna Cable SMA(F)/MHF 15cm |
| 1750007990-01 | Antenna 4G/LTE Full Band L=11 cm 50 Ohm |

Safety Instructions

1. Read these safety instructions carefully.
2. Keep this User Manual for later reference.
3. Disconnect this equipment from any AC outlet before cleaning. Use a damp cloth. Do not use liquid or spray detergents for cleaning.
4. For plug-in equipment, the power outlet socket must be located near the equipment and must be easily accessible.
5. Keep this equipment away from humidity.
6. Put this equipment on a reliable surface during installation. Dropping it or letting it fall may cause damage.
7. The openings on the enclosure are for air convection. Protect the equipment from overheating. **DO NOT COVER THE OPENINGS.**
8. Make sure the voltage of the power source is correct before connecting the equipment to the power outlet.
9. Position the power cord so that people cannot step on it. Do not place anything over the power cord.
10. All cautions and warnings on the equipment should be noted.
11. If the equipment is not used for a long time, disconnect it from the power source to avoid damage by transient overvoltage.
12. Never pour any liquid into an opening. This may cause fire or electrical shock.
13. Never open the equipment. For safety reasons, the equipment should be opened only by qualified service personnel.
14. If one of the following situations arises, get the equipment checked by service personnel:
 - The power cord or plug is damaged
 - Liquid has penetrated into the equipment
 - The equipment has been exposed to moisture
 - The equipment does not work well, or you cannot get it to work according to the user's manual
 - The equipment has been dropped and damaged
 - The equipment has obvious signs of breakage

DISCLAIMER: This set of instructions is given according to IEC 704-1. Advantech disclaims all responsibility for the accuracy of any statements contained herein.

Safety Precaution – Static Electricity

Follow these simple precautions to protect yourself from harm and the products from damage.

- To avoid electrical shock, always disconnect the power from your PC chassis before you work on it. Don't touch any components on the CPU card or other cards while the PC is on.
- Disconnect power before making any configuration changes. The sudden rush of power as you connect a jumper or install a card may damage sensitive electronic components.

Contents

| | | |
|------------------|--------------------------------------|-----------|
| Chapter 1 | General Introduction | 1 |
| 1.1 | Introduction | 2 |
| 1.2 | Specifications | 2 |
| 1.2.1 | Functional Specifications | 2 |
| 1.3 | Mechanical Specifications | 3 |
| 1.4 | Electrical Specifications | 3 |
| 1.5 | Environmental Specifications | 3 |
| 1.6 | Block Diagram | 3 |
| | | |
| Chapter 2 | H/W Installation..... | 5 |
| 2.1 | Jumpers | 6 |
| 2.1.1 | Jumper Description | 6 |
| 2.1.2 | Jumper List | 6 |
| | Table 2.1: Jumper List | 6 |
| 2.1.3 | Jumper Setting | 7 |
| 2.2 | Connectors | 10 |
| 2.2.1 | Connector List | 10 |
| 2.2.2 | Connector Settings | 11 |
| 2.3 | Mechanical | 26 |
| 2.3.1 | Jumper and Connector Locations | 26 |
| 2.3.2 | Board Dimensions | 28 |
| 2.4 | LED | 29 |
| 2.5 | Quick Start of RSB-4680 | 29 |
| 2.5.1 | Debug Port Connection | 29 |
| 2.5.2 | Debug Port Setting | 29 |
| | | |
| Chapter 3 | Software Functionality | 31 |
| 3.1 | Introduction | 32 |
| 3.2 | Set up Build Environment | 32 |
| 3.2.1 | Install Docker | 32 |
| 3.2.2 | Get Base Image | 32 |
| 3.2.3 | Getting Android Source Code | 32 |
| 3.2.4 | Building Android 6.0.1 image | 33 |
| 3.3 | GPIO | 34 |
| 3.4 | UART | 36 |
| 3.5 | Audio | 37 |
| 3.6 | SD/MMC Card | 38 |
| 3.6.1 | Browse the SD | 38 |
| 3.7 | USB DISK | 39 |
| 3.7.1 | USB Disk Status | 39 |
| 3.8 | HDMI | 41 |
| 3.8.1 | HDMI Resolution | 41 |
| 3.8.2 | HDMI Audio | 41 |
| 3.9 | Multi-Display | 42 |
| 3.9.1 | VGA(edp) and HDMI(4K) | 42 |
| 3.9.2 | HDMI(4K) and LVDS | 42 |
| 3.9.3 | LVDS and VGA (edp) | 42 |
| 3.10 | Network Setup | 43 |
| 3.10.1 | WIFI | 43 |
| 3.10.2 | BT | 44 |
| 3.10.3 | 3G/4G | 45 |

| | |
|-----------------------|----|
| 3.10.4 Ethernet | 46 |
|-----------------------|----|

| | | |
|------------------|---------------------------------|-----------|
| Chapter 4 | Advantech Services | 49 |
|------------------|---------------------------------|-----------|

| | | |
|-------|-------------------------------|----|
| 4.1 | RISC Design-In Services | 50 |
| 4.2 | Contact Information..... | 53 |
| 4.3 | Global Service Policy | 54 |
| 4.3.1 | Warranty Policy..... | 54 |
| 4.3.2 | Repair Process | 55 |

Chapter 1

General Introduction

This chapter gives background information on the RSB-4680

Sections include:

- Introduction
- Specifications

1.1 Introduction

RSB-4680 is a RISC 3.5" single board computer (SBC) powered by a high-performance Rockchip RK3288 Cortex-A17 Quad 1.6 GHz processor which supports 4K display from HDMI. RSB-4680 also features Mini-PCIe, M.2 and SIM card slots for integrating Wi-Fi, Bluetooth, and 4G modules.

The RSB-4680 offers multiple I/O connectivity with 6 USB 2.0, 6 COM, and 8 GPIOs. The system supports dual display for LVDS, HDMI and VGA.

RSB-4680 is an ideal hardware solution for the industrial market while also flexible enough to be applied to variant applications such as kiosks, vending machines and POS device-related applications.

1.2 Specifications

1.2.1 Functional Specifications

- **Processor:**
 - ROCKCHIP ARM Cortex™-A17 high performance processor, Quad core up to 1.6 GHz
 - Supports OpenGL ES 1.1/2.0/3.0, OpenCL 1.1, DirectX 11
 - Video decoder: MPEG-1, MPEG-2, MPEG-4, H.263, H.264, AVS, VC-1, VP8, MVC, HEVC/H.265 decoder, 4k@60FPS
 - Video Encoder: H.264 (BP@level4.0, MP, HP@level4.0), MVC and VP8
- **System Memory Support:**
 - DDR3L 1333 MHz
 - Capacity: On-board DDR3L 2GB
- **Gigabit Ethernet:**
 - Chipset: TI DP83867
 - 1 x 10/100/1000 Mbps
- **Peripheral Interface:**
 - 1 x Dual channel 18/24/30 bit LVDS
 - 1 x HDMI, 3840 x 2160
 - 1 x VGA, 1920 x 1200
 - 1 x USB OTG, 2 x USB Type A, and 3 x USB pin headers
 - 1 x Line Out
 - 1 x Mic In
 - 1 x Speaker out
 - 1 x Micro SD slot
 - 1 x 2 wires RS-232/debug port pin header, 1 x 4-wire RS-232/485 DB9 Connector, 4 x 4-wire RS-232 pin header
 - 1 x mini PCIe slot
 - 1 x M.2 slot
 - 1 x SIM slot
 - 1 x SPI
 - 1 x I2C
 - 8 x GPIO
- **OS Support:** RSB-4680 supports Android and Linux

1.3 Mechanical Specifications

- **Dimension:** 146 x 102 mm (3.5")
- **Height:** 17.8 mm
- **Reference Weight:** 200g (including whole package)

1.4 Electrical Specifications

- **Power supply type:** DC-in 12V
- **RTC Battery:**
 - Typical voltage: 3V
 - Normal discharge capacity: 210 mAh

1.5 Environmental Specifications

- **Operating temperature:** 0~60°C (32~140°F)
- **Operating humidity:** 5% ~ 95% relative humidity, non-condensing
- **Storage temperature:** -40~85°C (-40~185°F)
- **Storage humidity:** 60°C @ 95% RH Non-condensing

1.6 Block Diagram

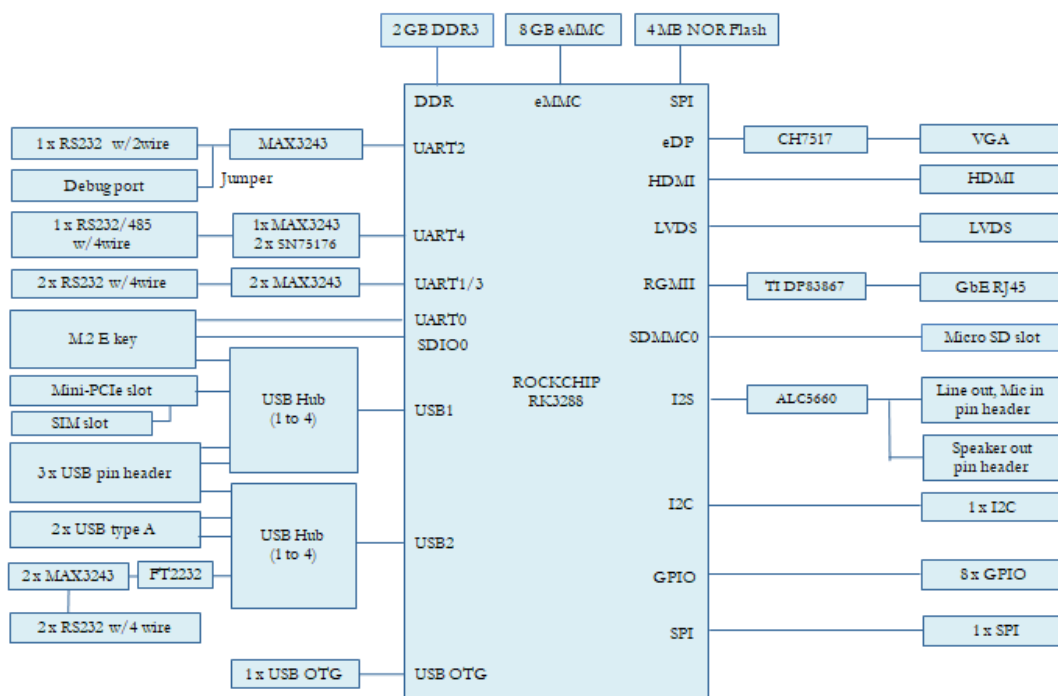

Chapter 2

H/W Installation

This chapter gives mechanical and connector information on the RSB-4680

Sections include:

- Jumper Information
- Connector Information
- Mechanical Drawing
- Quick Start Guide

2.1 Jumpers

2.1.1 Jumper Description

Cards can be configured by setting jumpers. A jumper is a metal bridge used to close an electric circuit. It consists of two metal pins and a small metal clip (often protected by a plastic cover) that slides over the pins to connect them. To close a jumper, connect the pins with the clip. To open a jumper, remove the clip. Sometimes a jumper will have three pins, labeled 1, 2, and 3. In this case you would connect either pins 1 and 2 or 2 and 3.

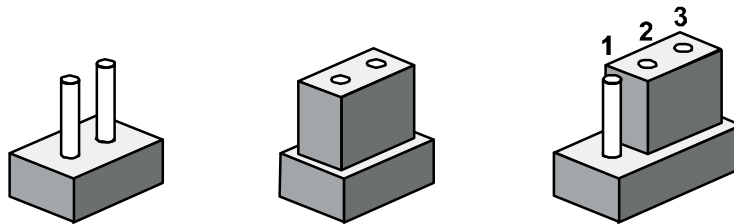

The jumper settings are schematically depicted in this manual as follows

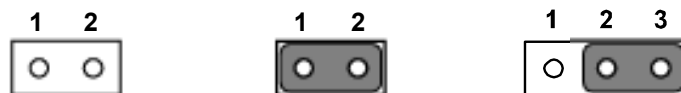

A pair of needle-nose pliers may be helpful when working with jumpers. If you have any doubts about the best hardware configuration for your application, contact your local distributor or sales representative before you make any changes.

Generally, you simply need a standard cable to make most connections.

Warning! To avoid damaging the computer, always turn off the power supply before setting jumpers.



2.1.2 Jumper List

Table 2.1: Jumper List

| | |
|-----------|---|
| LVDS_BLP | LVDS Backlight Power Jumper |
| LVDS_VDD1 | LVDS Power Jumper1 |
| LVDS_VDD2 | LVDS Power Jumper2 |
| SW3 | AT & ATX Mode Switch |
| CN6 | COM6 & COM7 5V/12V Power Select |
| CN18 | RS485 Impedance Select & Console Select |
| CN19 | MASKROM Mode Select |
| JSETCOM4 | COM4 RS232/RS485 Mode Select |

2.1.3 Jumper Setting

| LVDS_BLP | LVDS Backlight Power |
|-----------------|--|
| Part number | 1653003101 |
| Footprint | HD_3x1P_79_D |
| Description | PIN HEADER 3x1P 2.0mm 180D(M) DIP 2000-13 WS |
| Setting | Function |
| (1-2) | +5V |
| (2-3) | +12V(default) |

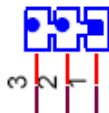

| LVDS_VDD1 | LVDS Power Jumper1 |
|------------------|--|
| Part number | 1653003101 |
| Footprint | HD_3x1P_79_D |
| Description | PIN HEADER 3x1P 2.0mm 180D(M) DIP 2000-13 WS |
| Setting | Function |
| (1-2) | 3.3V |
| (2-3) | 5V(default) |

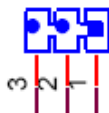

| LVDS_VDD2 | LVDS Power Jumper2 |
|------------------|--|
| Part number | 1653002101-02 |
| Footprint | PH2x1P-2.0 |
| Description | PIN HEADER 2x1P 2.0mm 180D(M) DIP 21N12050 |
| Setting | Function |
| (1-2) | 12V |



| | |
|-------------|--|
| SW3 | AT & ATX Mode Switch |
| Part Number | 1600000071 |
| Footprint | SW_3P_CJS-1201TA1 |
| Description | SLIDE SW CJS-1201TA1 SMD 3P SPDT P=6.0mm W=2.5mm |
| Setting | Function |
| (2-1) | ATX Mode |
| (2-2) | Floating |
| (2-3) | AT Mode (default) |

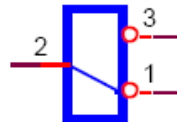

| | |
|-------------|--|
| CN6 | COM6 & COM7 5V/12V Power Select |
| Part Number | 1653003101 |
| Footprint | HD_3x1P_79_D |
| Description | PIN HEADER 3x1P 2.0mm 180D(M) DIP 2000-13 WS |
| Setting | Function |
| 1 | VCC_SYS(+5V) (default) |
| 2 | COM6_PWR & COM7_PWR |
| 3 | +12V |

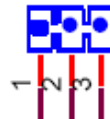

| | |
|-------------|--|
| CN18 | RS485 Impedance mode and Console mode Selection |
| Part Number | 1653003260 |
| Footprint | HD_3x2P_79 |
| Description | PIN HEADER 3x2P 2.0mm 180D(M) SMD 21N22050 |
| Setting | Pin Name |
| (1-3) | COM2 RS232 |
| (2-4) | COM4 RS485 Impedance off (default) |
| (3-5) | Console (default) |
| (4-6) | COM4 RS485 Impedance on |

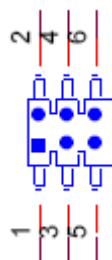

| | |
|-------------|--|
| CN19 | MASKROM Mode Select |
| Part Number | 1653003101 |
| Footprint | HD_3x1P_79_D |
| Description | PIN HEADER 3x1P 2.0mm 180D(M) DIP 2000-13 WS |
| Setting | Pin Name |
| (1-2) | Disable eMMC |
| (2-3) | Enable eMMC(default) |

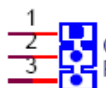

| | |
|------------------------|--|
| JSETCOM4 | COM4 RS232/RS485 Mode Select |
| Part number | 1653007260 |
| Footprint | HD_7x2P_79 |
| Description | PIN HEADER 2x7P 2.0mm 180D(M) SMD 21N22050 |
| Setting | Function |
| (2-4 8-10 11-13 12-14) | RS232 Mode (default) |
| (1-2 5-7 6-8 9-11) | RS485 Mode |

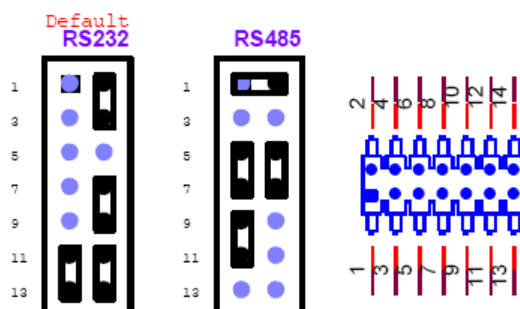

2.2 Connectors

2.2.1 Connector List

| | |
|----------|--|
| BAT | RTC Battery Connector |
| CN2 | Audio |
| CN3 | GPIO |
| CN4 | 18/24/30 bit Dual-Channel LVDS |
| LVDS_BL | LVDS Backlight Control |
| CN5 | Power Button & LED |
| CN7 | Recover |
| CN16 | 12V DC Jack |
| CN20 | Internal USB Pin Header |
| USB34 | Dual Type A USB Connector |
| OTG | Micro USB Connector |
| CN21 | SPI |
| CN22 | I2C |
| COM | Internal RS232 (COM6 & COM7 with 12V/5V Power) |
| COM13 | Internal RS232 (COM1 & COM3) |
| COM4 | External COM (With RS232 &RS-485) |
| DEBUG | COM2 or Console |
| HDMI | HDMI |
| LAN | LAN |
| M.2 | M.2 |
| MINIPCIE | MINIPCIE |
| SD | Micro SD |
| SIM1 | Standard SIM |
| SW2 | Reset Button |
| VGA | VGA |

2.2.2 Connector Settings

2.2.2.1 RTC Battery Connector (BAT)

RSB-4680 supports a lithium 3V/210mAh CR2032 battery with wire via battery connector.

| Pin | Pin Name |
|-----|----------|
| 1 | COIN_RTC |
| 2 | GND |

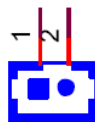

2.2.2.2 Audio (CN2)

RSB-4680 supports line-out stereo speakers, MIC in and speaker out. Earphones can be connected to the line-out pin header, and the microphone can be connected to the MIC in pin header. It also supports mono speaker. (2.8W 4Ω or 1.5W 8Ω)

Detailed pin-definitions are below:

| Pin | Pin Name | Pin | Pin Name |
|-----|----------------------|-----|----------------------|
| 1 | Line-out R+ (AMP_R+) | 2 | Line-out L+ (AMP_R-) |
| 3 | AMP_R- | 4 | AMP_L- |
| 5 | AMP_AGND | 6 | GND_AUDIO |
| 7 | MIC_IN1_P | 8 | MIC_IN1_N |
| 9 | MIC_IN3_P | 10 | MIC_IN3_N |
| 11 | SPEAKER_P | 12 | SPEAKER_N |

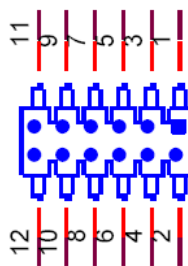

Audio Connector

2.2.2.3 GPIO (CN3)

RSB-4680 provides internal GPIO interface by a 5X2 pin header.

| Pin | Pin Name | Pin | Pin Name |
|-----|---------------|-----|----------|
| 1 | GPIO0 | 2 | GPIO1 |
| 3 | GPIO2 | 4 | GPIO3 |
| 5 | GPIO4 | 6 | GPIO5 |
| 7 | GPIO6 | 8 | GPIO7 |
| 9 | VCC_IO(+3.3V) | 10 | GND |

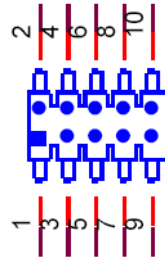

GPIO Pin Header

2.2.2.4 LVDS Connector (CN4)

RSB-4680 provides a LVDS 20x2-pin board-to-board connector for dual channel 18/24/30 bit LVDS panel up to 1920 x 1080. For avoid to damage to the LCD panel, please make sure to set the right voltage level before powering on while connecting a LVDS panel (refer to jumper setting description for LVDS_BLP, LVDS_VDD1 and LVDS_VDD2 and LCD datasheet that you will use).

| Pin | Pin Name | Pin | Pin Name |
|-----|--------------|-----|--------------|
| 1 | +VDD_LVDS | 2 | +VDD_LVDS |
| 3 | GND | 4 | GND |
| 5 | +VDD_LVDS | 6 | +VDD_LVDS |
| 7 | LVDS0_D0- | 8 | LVDS1_D0- |
| 9 | LVDS0_D0+ | 10 | LVDS1_D0+ |
| 11 | GND | 12 | GND |
| 13 | LVDS0_D1- | 14 | LVDS1_D1- |
| 15 | LVDS0_D1+ | 16 | LVDS1_D1+ |
| 17 | GND | 18 | GND |
| 19 | LVDS0_D2- | 20 | LVDS1_D2- |
| 21 | LVDS0_D2+ | 22 | LVDS1_D2+ |
| 23 | GND | 24 | GND |
| 25 | LVDS0_CLK- | 26 | LVDS1_CLK- |
| 27 | LVDS0_CLK+ | 28 | LVDS1_CLK+ |
| 29 | GND | 30 | GND |
| 31 | LVDS0_D3- | 32 | LVDS1_D3- |
| 33 | LVDS0_D3+ | 34 | LVDS1_D3+ |
| 35 | LVDS_DDC_DAT | 36 | LVDS_DDC_CLK |
| 37 | LVDS0_D4- | 38 | LVDS1_D4- |
| 39 | LVDS0_D4+ | 40 | LVDS1_D4+ |

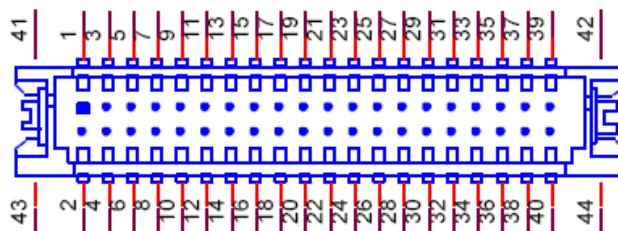

LVDS Connector

2.2.2.5 LVDS Backlight Connector (LVDS_BL)

For avoiding to damage LCD panel, please make sure set a right voltage level before power on while connecting a LVDS panel (refer to jumper setting description for LVDS_BLP and LCD datasheet that you will use).

| Pin | Pin Name |
|-----|----------------|
| 1 | +VDD_BKLT_LVDS |
| 2 | GND |
| 3 | LVDS_BKLT_EN |
| 4 | LVDS_BKLT_PWM |
| 5 | VCC_SYS(+5V) |

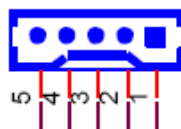

LVDS Backlight Connector

2.2.2.6 Power Button & LED (CN5)

RSB-4680 supports power button, power LED light and 4G LED light by 2x3 pin header.

| Pin | Pin Name |
|-----|----------------------|
| 1 | PWR BTN(PWR_BTN+) |
| 2 | GND(PWR_BTN-) |
| 3 | PWR_LED(PWR_LED+) |
| 4 | GND(PWR_LED-) |
| 5 | +3.3V_PCIe(4G_LED+) |
| 6 | 4GLED_WWAN#(4G_LED-) |



Power Button, Power LED and 4G LED Pin Header

2.2.2.7 Recover (CN7)

RSB-4680 provides a 1X2 pin header for Recover Signal.

| Pin | Description |
|-----|-------------|
| 1 | GND |
| 2 | RECOVER |

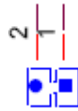

Recover signal pin header

2.2.2.8 DC Power Jack (CN16)

RSB-4680 supports a DC-Jack header that can be connected 12V DC external power input.

| Pin | Description |
|-----|-------------|
| 1 | +12V |
| 2 | PGND |
| 3 | PGND |

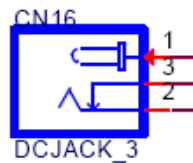

DC Jack

2.2.2.9 USB (Internal Pin Header) (CN20)

RSB-4680 provides extra internal 3 x USB 2.0 pin header.

| Pin | Description |
|-----|---------------|
| 1 | +5V_USB12 |
| 2 | +5V_USB12 |
| 3 | USB1_D- |
| 4 | USB2_D- |
| 5 | USB1_D+ |
| 6 | USB2_D+ |
| 7 | GND |
| 8 | GND |
| 9 | USB5_D- |
| 10 | +5V_USB5 |
| 11 | USB5_D+ |
| 12 | NC |
| 13 | GND |
| 14 | GND_Shielding |
| 15 | GND_Shielding |

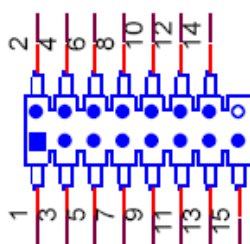

USB Pin header

2.2.2.10 USB Type A Connector (USB34)

RSB-4680 supports one standard USB2.0 Type A connector on the coastline.

| Pin | Description |
|-----|-------------|
| 1 | +5V_USB34 |
| 2 | USB3_D- |
| 3 | USB3_D+ |
| 4 | GND |
| 5 | +5V_USB34 |
| 6 | USB4_D- |
| 7 | USB4_D+ |
| 8 | GND |

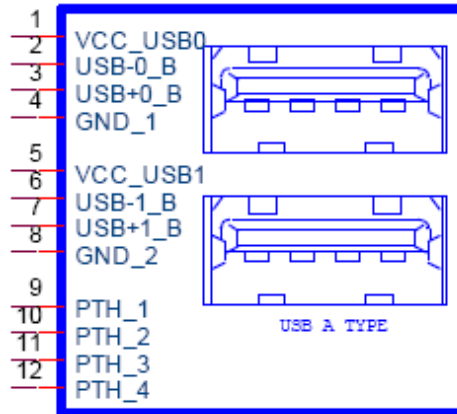

USB port connector

2.2.2.11 Micro USB Connector (OTG)

RSB-4680 supports one USB OTG port on the coastline.

| Pin | Description |
|-----|-------------|
| 1 | OTG5V |
| 2 | USB_OTG_D- |
| 3 | USB_OTG_D+ |
| 4 | ID |
| 5 | GND |

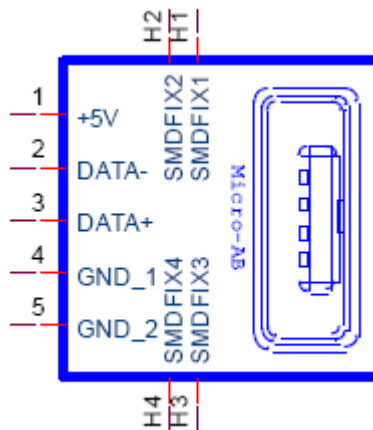

Micro USB Connector

2.2.2.12 SPI (CN21)

RSB-4680 provides one SPI pin header.

| Pin | Description |
|-----|--------------|
| 1 | VCC_IO(3.3V) |
| 2 | GND |
| 3 | SPI_CS0# |
| 4 | SPI_CLK |
| 5 | SPI_MOSI |
| 6 | SPI_MISO |



SPI Pin header

2.2.2.13 I²C (CN22)

RSB-4680 provides one I²C pin header.

| Pin | Description |
|-----|-----------------------|
| 1 | +3.3V |
| 2 | GND |
| 3 | Touch_INT# |
| 4 | I ² C4_SCL |
| 5 | NC |
| 6 | I ² C4_SDA |



I²C Pin header

2.2.2.14 RS232/485 (COM4)

RSB-4680 provides one D-Sub 9-pin connector serial communication interface port. The port can support RS-232/485 mode communication.

| Pin | Description |
|-----|-------------|
| 1 | COM4_DCD_a |
| 2 | COM4_RX_a |
| 3 | COM4_TX_a |
| 4 | NC |
| 5 | GND |
| 6 | NC |
| 7 | COM4_RTS |
| 8 | COM4_CTS |
| 9 | NC |

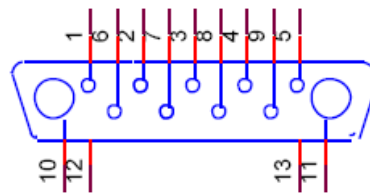

COM Port

2.2.2.15 RS232/Debug Port (COM2)

RSB-4680 can communicate with a host server (Windows or Linux) by using debug cable. (Advantech number: 1700021565-11). Refer to jumper CN18.

| Pin | Description |
|-----|-------------|
| 1 | NC |
| 2 | COM2_TX |
| 3 | COM2_RX |
| 4 | GND |

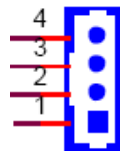

Debug Port/Internal RS232 Pin Header

2.2.2.16 Internal RS232 (COM)

RSB-4680 provides 2 x internal 4 wires RS-232 ports with 5V/12V selection. (Refer to Jumper CN6).

| Pin | Description |
|-----|-------------|
| 1 | COM6_TXD |
| 2 | COM6_RXD |
| 3 | COM6_RTS# |
| 4 | COM6_CTS# |
| 5 | COM6_PWR |
| 6 | GND |
| 7 | GND |
| 8 | COM7_PWR |
| 9 | COM7_CTS# |
| 10 | COM7_RTS# |
| 11 | COM7_RXD |
| 12 | COM7_TXD |

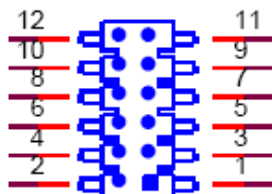

Internal RS232 Pin Header

2.2.2.17 Internal RS232 (COM13)

RSB-4680 provides 2 x internal 4 wires RS-232 ports.

| Pin | Description |
|-----|-------------|
| 1 | COM1_TXD |
| 2 | COM1_RXD |
| 3 | COM1_RTS# |
| 4 | COM1_CTS# |
| 5 | NC |
| 6 | GND |
| 7 | GND |
| 8 | NC |
| 9 | COM3_CTS# |
| 10 | COM3_RTS# |
| 11 | COM3_RXD |
| 12 | COM3_TXD |

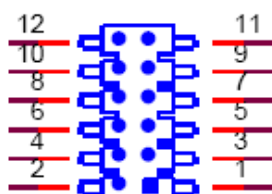

Internal RS232 Pin Header

2.2.2.18 HDMI Display Interface (HDMI)

RSB-4680 provides one HDMI interface connector. HDMI technology can support a maximum resolution of 3840 x 2160, but the actual resolution supported depends on the monitor being used.

| Pin | Description | Pin | Description |
|-----|-------------|-----|---------------|
| 1 | HDMI_D2+ | 11 | GND |
| 2 | GND | 12 | HDMI_CLK- |
| 3 | HDMI_D2- | 13 | HDMI_CEC |
| 4 | HDMI_D1+ | 14 | NC |
| 5 | GND | 15 | HDMI_CTRL_CLK |
| 6 | HDMI_D1- | 16 | HDMI_CTRL_DAT |
| 7 | HDMI_D0+ | 17 | GND |
| 8 | GND | 18 | +5V_HDMI_2 |
| 9 | HDMI_D0- | 19 | HDMI_HPD |
| 10 | HDMI_CLK+ | | |

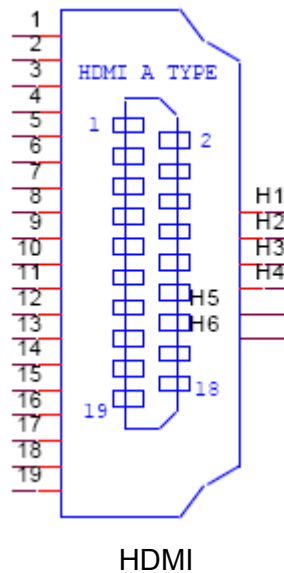

2.2.2.19 Ethernet Connector (LAN)

RSB-4680 provides one RJ45 LAN interface connector, which is compliant with 1000 base-T IEEE 802.ab, 100 base-TX IEEE 802.u, 10 base-t IEEE 802.3. The Ethernet ports provide standard RJ-45 jack connector with LED indicators on the front side to show Active/Link status and Speed status.

| Pin | Description |
|-----|------------------------|
| R1 | 100nF Capacitor to GND |
| R2 | MDI0+ |
| R3 | MDI0- |
| R4 | MDI1+ |
| R5 | MDI1- |
| R6 | MDI2+ |
| R7 | MDI2- |
| R8 | MDI3+ |
| R9 | MDI3- |
| R10 | GND |
| L1 | LAN1_100_LINK# |
| L2 | LAN1_1000_LINK# |
| L3 | Pull up to +3.3V |
| L4 | LAN1_ACT |

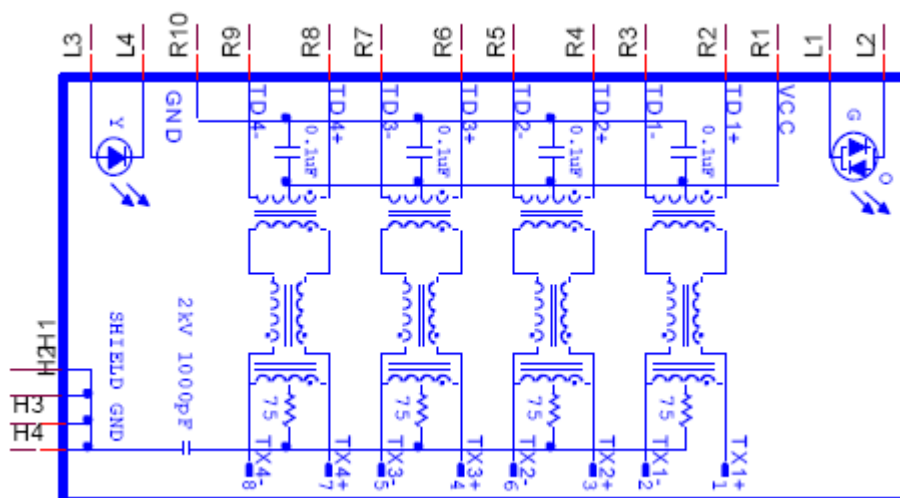

Ethernet Connector

2.2.2.20 M.2 Slot (M.2)

RSB-4680 supports M.2 2230 Key.E slot with SDIO, I2C and USB interface.

| Pin | Signal Name | Pin | Signal Name |
|----------------|----------------|----------------|----------------|
| 1 | GND | 2 | +3.3V_M2 |
| 3 | USB_M.2_P | 4 | +3.3V_M2 |
| 5 | USB_M.2_N | 6 | WLAN_LED |
| 7 | GND | 8 | NC |
| 9 | M2_SDIO_CLK | 10 | NC |
| 11 | M2_SDIO_CMD | 12 | NC |
| 13 | M2_SDIO_DAT0 | 14 | NC |
| 15 | M2_SDIO_DAT1 | 16 | BT_LED |
| 17 | M2_SDIO_DAT2 | 18 | GND |
| 19 | M2_SDIO_DAT3 | 20 | NC |
| 21 | M2_SDIO_WAKE# | 22 | UART0_RX |
| 23 | M2_SDIO_B_RST | | |
| Mechanical Key | Mechanical Key | Mechanical Key | Mechanical Key |
| | NC | 32 | UART0_TX |
| 33 | GND | 34 | UART0_CTSN |
| 35 | NC | 36 | UART0_RTSN |
| 37 | NC | 38 | NC |
| 39 | GND | 40 | NC |
| 41 | NC | 42 | NC |
| 43 | NC | 44 | NC |
| 45 | GND | 46 | NC |
| 47 | NC | 48 | NC |
| 49 | NC | 50 | SUS_CLK |
| 51 | GND | 52 | NC |
| 53 | NC | 54 | W_DISABLE2# |
| 55 | NC | 56 | W_DISABLE1# |
| 57 | GND | 58 | NC |
| 59 | NC | 60 | NC |
| 61 | NC | 62 | NC |
| 63 | GND | 64 | NC |
| 65 | NC | 66 | NC |
| 67 | NC | 68 | NC |
| 69 | GND | 70 | NC |
| 71 | NC | 72 | +3.3V_M2 |
| 73 | NC | 74 | +3.3V_M2 |
| 75 | GND | | |

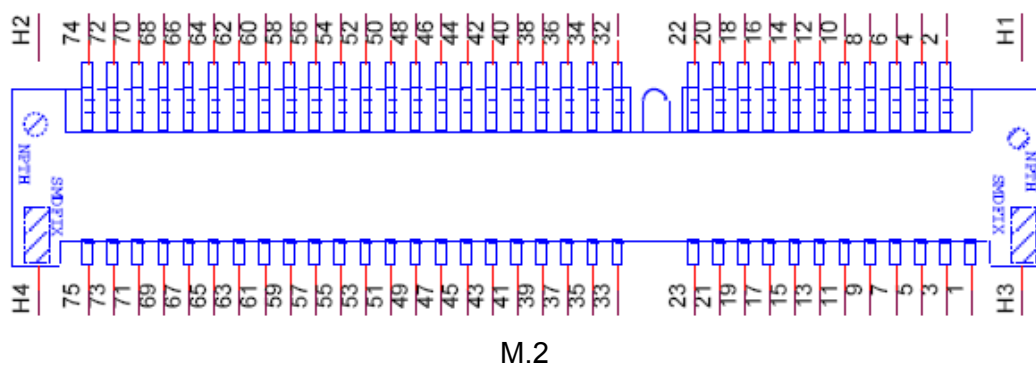

2.2.2.21 Mini PCIE

RSB-4680 supports Mini-PCIE interface.

| Pin | Signal Name | Pin | Signal Name |
|-----|-------------|-----|----------------|
| 1 | NC | 2 | +3.3V_PcIe |
| 3 | NC | 4 | GND |
| 5 | NC | 6 | NC |
| 7 | NC | 8 | UIM_PWR |
| 9 | GND | 10 | UIM_DATA |
| 11 | NC | 12 | UIM_CLK |
| 13 | NC | 14 | UIM_RST |
| 15 | GND | 16 | UIM_VPP |
| 17 | NC | 18 | GND |
| 19 | NC | 20 | W_DISABLE# |
| 21 | GND | 22 | PERST# |
| 23 | NC | 24 | NC |
| 25 | NC | 26 | GND |
| 27 | GND | 28 | NC |
| 29 | GND | 30 | NC |
| 31 | NC | 32 | NC |
| 33 | NC | 34 | GND |
| 35 | GND | 36 | USB_MINIPCIE_N |
| 37 | GND | 38 | USB_MINIPCIE_P |
| 39 | +3.3V_PcIe | 40 | GND |
| 41 | +3.3V_PcIe | 42 | LED_WWAN# |
| 43 | GND | 44 | LED_WLAN# |
| 45 | NC | 46 | LED_WPAN# |
| 47 | NC | 48 | NC |
| 49 | NC | 50 | GND |
| 51 | NC | 52 | +3.3V_PcIe |

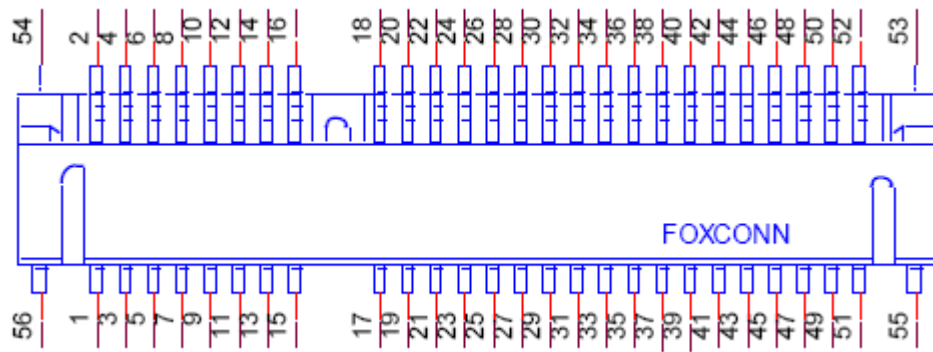

MINI-PCle

2.2.2.22 Micro SD Slot (SD)

RSB-4680 supports SD/MMC card in Class 2, 4, 6, 8, 10. Supported capacity is up to 32GB (SDHC). Advantech uses 4G SD for the DQA test (SDHC).

| Pin | Signal Name |
|-----|-------------|
| 1 | SD_DAT2 |
| 2 | SD_DAT3 |
| 3 | SD_CMD |
| 4 | VCC_SD |
| 5 | SD_CLK |
| 6 | GND |
| 7 | SD_DAT0 |
| 8 | SD_DAT1 |
| CD | SD_CD |

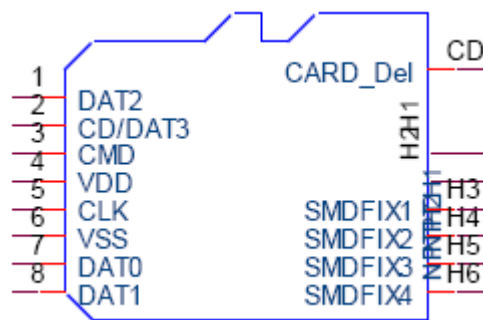

Micro SD Slot

2.2.2.23 SIM Card Slot (SIM1)

RSB-4680 supports on board SIM socket for 4G integration. Please insert valid SIM card to dial 4G network.

| Pin | Description |
|-----|-------------|
| C1 | SIM_VCC |
| C2 | SIM_RST |
| C3 | SIM_CLK |
| C5 | GND |
| C6 | SIM_VPP |
| C7 | SIM_DATA |
| SW1 | NC |
| SW2 | NC |

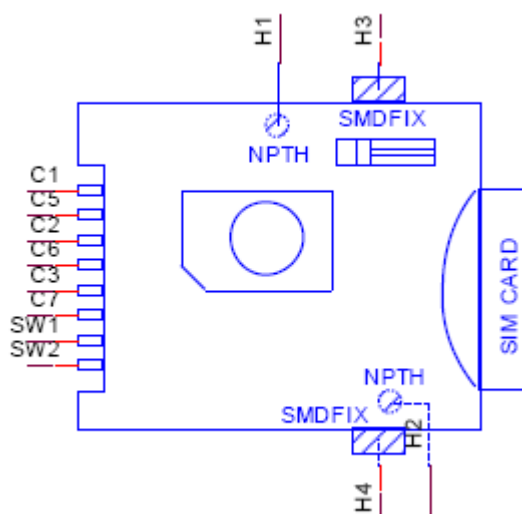

SIM Card Slot

2.2.2.24 Reset button (SW2)

RSB-4680 supports a reset button on the coastline.

| Pin | Description |
|-----|-------------|
| 1 | RST BTN |
| 2 | GND |
| 3 | GND_F |
| 4 | GND_F |

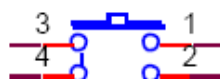

Reset Button

2.2.2.25 VGA Display Interface (VGA)

RSB-4680 provides standard VGA connector. VGA resolution supports up to 1920x1200.

| Pin | Description | Pin | Description |
|-----|-------------|-----|-------------|
| 1 | RED | 9 | +5V_CRT |
| 2 | GREEN | 10 | GND |
| 3 | BLUE | 11 | N/A |
| 4 | N/A | 12 | DDC_DATA |
| 5 | GND | 13 | HSYNC |
| 6 | GND | 14 | VSYNC |
| 7 | GND | 15 | DDC_CLK |
| 8 | GND | | |

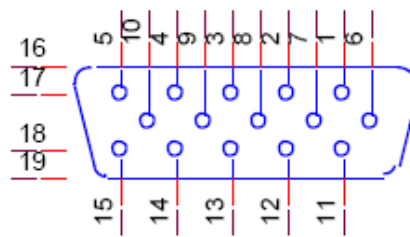

VGA Connector

2.3 Mechanical

2.3.1 Jumper and Connector Locations

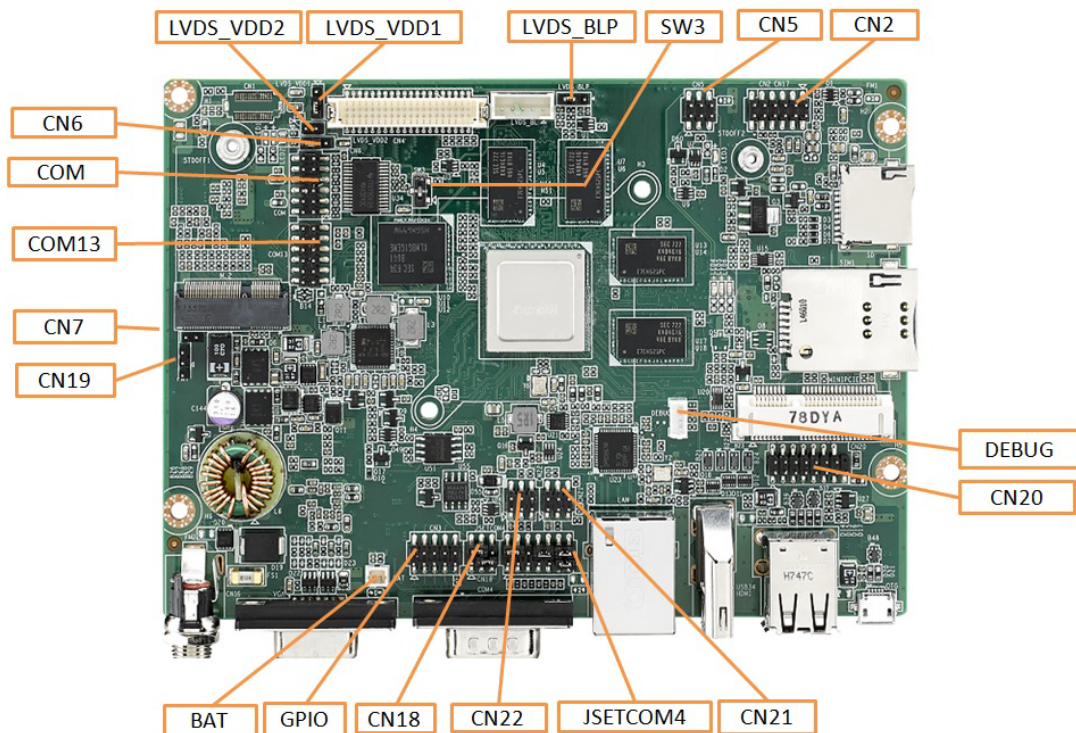

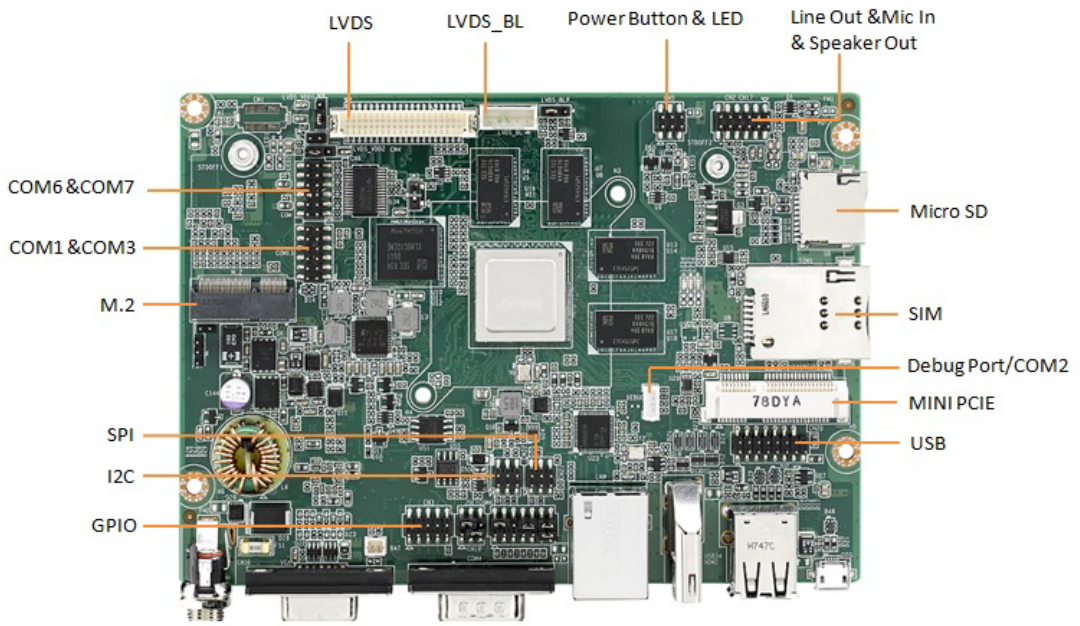
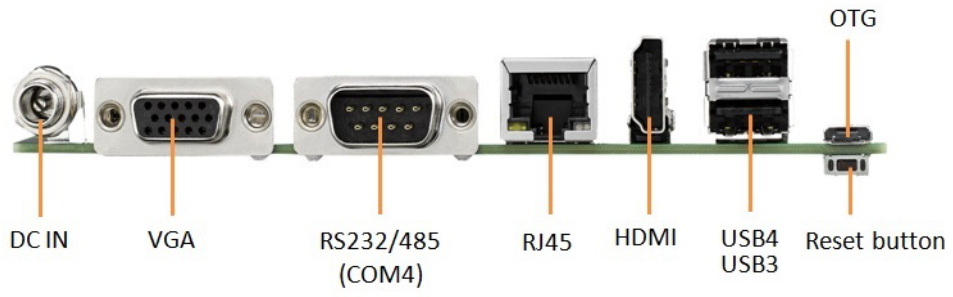

2.3.2 Board Dimensions

2.3.2.1 Board Drawing

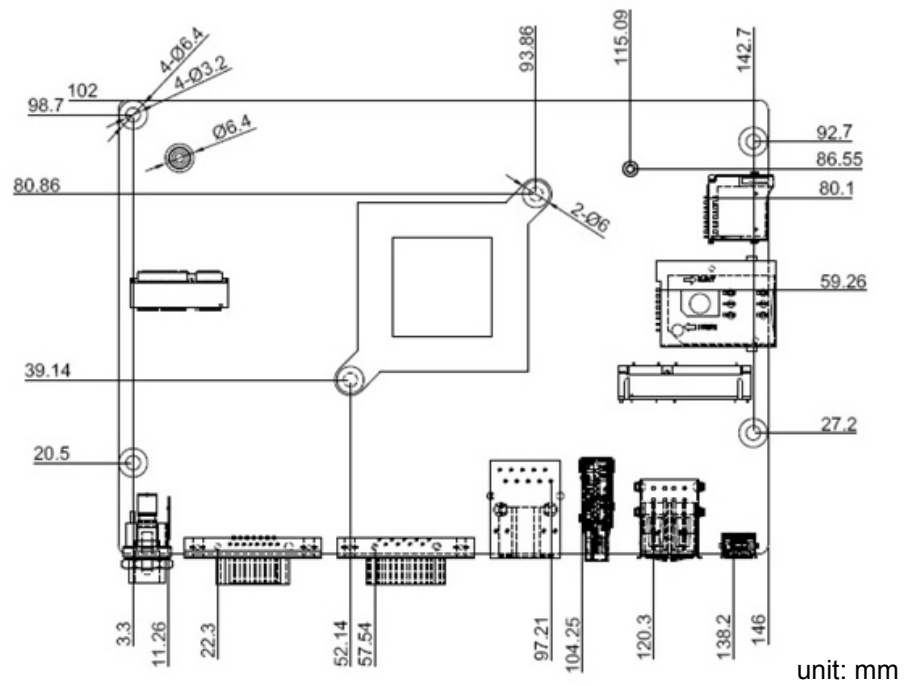

Board Dimension Layout (Top Side)

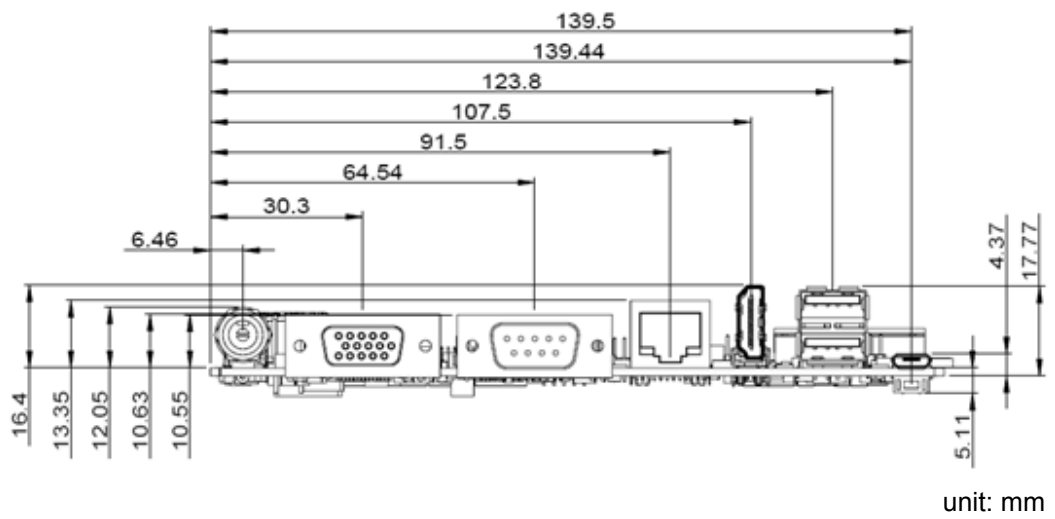

2.4 LED

| Name | Description |
|------|--------------------------|
| LED3 | Power_LED |
| LED4 | PCIE Mini Card LED_WWAN# |
| LED5 | PCIE Mini Card LED_WLAN# |
| LED6 | PCIE Mini Card LED_WPAN# |

2.5 Quick Start of RSB-4680

2.5.1 Debug Port Connection

1. Connect debug cable to RSB-4680 debug port (refer figure 2.3.1)
2. Connect the other side of debug cable to USB-to-RS-232 cable then connect to your PC.

2.5.2 Debug Port Setting

RSB-4680 can communicate with a host server by using serial cables. Common serial communication programs such as HyperTerminal, Tera Term or PuTTY can be used in this case. The example as below describes the serial terminal setup using HyperTerminal on a Windows host:

1. Connect RSB-4680 with your PC by using a serial cable.
2. Open HyperTerminal on your Windows PC and select the settings as shown in Figure 2.7.
3. After the bootloader is programmed on SD card, insert power adapter connector to DC jack on RSB-4680 to power up the board. The boot loader prompt is displayed on the terminal screen.

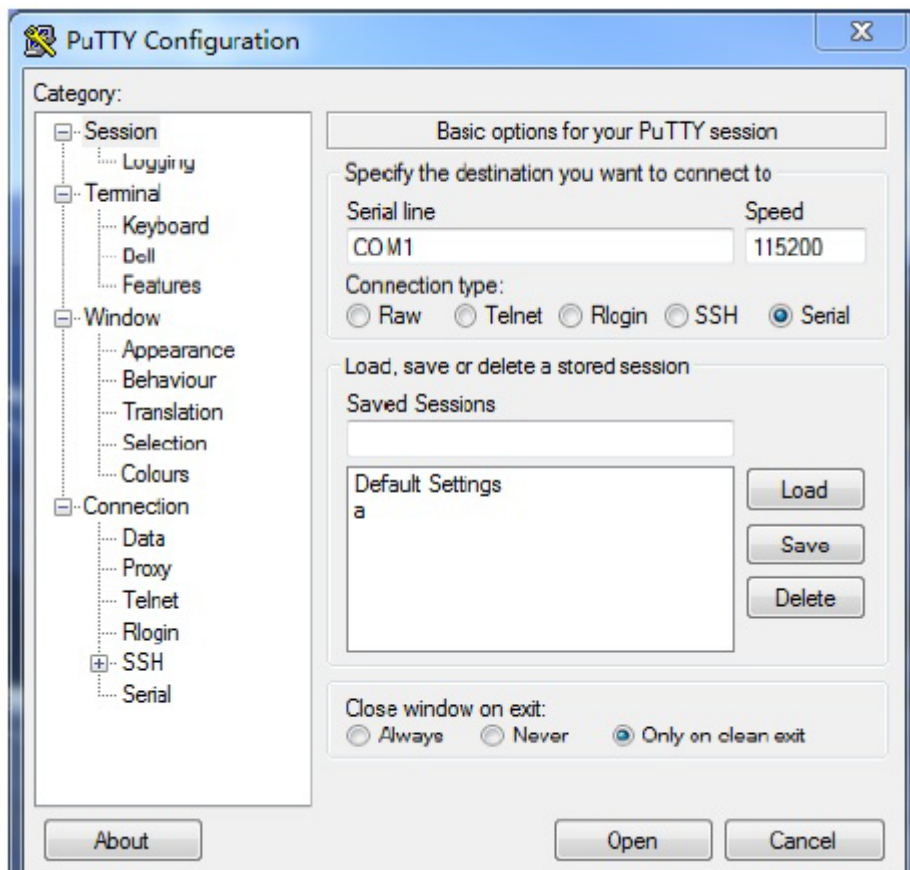

HyperTerminal Settings for Terminal Setup

Chapter 3

Software Functionality

This chapter details the software programs on the RSB-4680 platform.

3.1 Introduction

The purpose of this chapter is to introduce software development of RSB-4680 to you, so that you can develop your own application(s) efficiently.

RSB-4680 is designed for supporting Linux host only so you may fail developing your AP on Windows/Android host PC. For now, the official supported host version is Ubuntu 14.04 LTS 64bit. The host PC in any other version may have compatibility issues. In this case, we strongly recommend having Ubuntu 14.04 LTS 64bit installed on your host PC before starting RSB-4680 evaluation/development.

3.2 Set up Build Environment

All instructions in this guide are based on Ubuntu 14.04 LTS 64bit only. Please install Ubuntu 14.04 LTS 64bit with minimum 4GB DRAM in advance, login to installed system, and perform the following sections:

3.2.1 Install Docker

Before you use Docker to develop, you have to install Docker on your platform. Please refer to Docker Installation Guide. You are able to install Docker on Linux, Cloud, Windows, and OS X. In general, you may choose to install on Ubuntu.

3.2.2 Get Base Image

To get the images we provided, you can use `docker pull <IMAGE REPOSITORY>` to get the images in the image list.

```
# docker pull advrisc/u14.04-rk3288abv1
```

3.2.3 Getting Android Source Code

Related version information:

- Android 6.0.1
- Kernel 3.10.0
- U-Boot 2014-10

To pull down the Android source tree to your working directory from the repositories as specified in the default manifest

```
$ mkdir myandroid
$ mkdir bin
$ cd myandroid/
$ curl https://storage.googleapis.com/git-repo-downloads/repo > ../bin/repo
$ chmod a+x ../bin/repo
$ ../bin/repo init -u https://github.com/ADVANTECH-Rockchip/android-rk-manifest.git -b
android-6.0.1
$ ../bin/repo sync
```

Some folders described below:

android/u-boot/

U-Boot source code

android/device/rockchip/

Android device related settings

hardware/rockchip/

HAL (Hardware Abstraction Layer)

android/kernel/

Linux kernel source code

3.2.4 Building Android 6.0.1 image**Start Docker Container**

```
# docker run -it --name android6.0-build -v /home/adv/myandroid:/home/adv/android6.0:rw
advrisc/u14.04-rk3288abv1 /bin/bash
```

Build Instructions

Set the \$JAVA_HOME environment variable

```
Set the $JAVA_HOME environme
```

Set up the environment for building. This only configures the current terminal.

```
$ source build/envsetup.sh
```

Execute the Android lunch command. In this example, the setup is for the production image of Advantech RISC platform device with user debug type. If you devices is RSB4680, you will be send command "lunch rsb4680-userdebug

```
$ lunch $PRODUCT-userdebug
```

To build boot loader

Perform the following command in terminal console

```
$ cd u-boot/
$ make rk3288_rsb4680a3_2G_defconfig
$ make -j4
```

The one file, RK3288UbootLoader_V2.30.10.bin, will be located in directory

To build kernel image

Perform the following command in terminal console

```
$ cd kernel/
$ make rk3288_adv_defconfig
$ make -j4 rk3288-rsb4680-a3.img
```

To build system image

Perform the following command in terminal console

```
$ make -j4
$ ./mkimage.sh
```

All android image will be generated in rockdev/Image-rsb4680/ folder.

Problems and Solutions

1. Compiled kernel

```
/bin/sh: 1: /home/zengwei/android_rk3288_android6.0/kernel/scripts/gcc-wrapper.py: Permission denied
make[1]: *** [kernel/bounds.s] Error 126
make: *** [prepare0] Error 2
make: *** Waiting for unfinished jobs....
HOSTCC scripts/dtc/dtc-parser.tab.o
HOSTLD scripts/dtc/dtc
make: *** [scripts] Error 2
Solution
$ chmod 555 kernel/scripts/gcc-wrapper.py
```

2. Compiled android? Please copy this file before compiling

```
$ cp .repo/manifests/default.xml manifest.xml
```

3.3 GPIO

The RK3288 bank/bit notation for GPIOs must be formed as "GPIO<GPIO_bank>_<gpio_bit>"

The numeric value of GPIO is calculated as follows:

$$32 \times (\text{gpio_bank}) + \text{gpio_bit} - 8$$

Group GPIO0 only 24 gpios, so each GPIO Num subtracts 8.

gpio_bit : A0?A7 0-7 B0?B7 8-15 C0?C7 16-23 D0?D7 24-31

E.g. GPIO2_A4 becomes 60

| GPIO Number | GPIO formed | Numeric Representation |
|-------------|-------------|------------------------|
| GPIO0 | GPIO7_A3 | 219 |
| GPIO1 | GPIO7_A4 | 220 |
| GPIO2 | GPIO7_A5 | 221 |
| GPIO3 | GPIO7_C5 | 237 |
| GPIO4 | GPIO8_A2 | 250 |
| GPIO5 | GPIO8_A3 | 251 |
| GPIO6 | GPIO8_A0 | 248 |
| GPIO7 | GPIO8_A1 | 249 |

Export GPIO then you can use control GPIO from user space through sysfs.

Export GPIO0

```
shell@rsb4680:/ $ echo 219 > /sys/class/gpio/export
```

Set GPIO direction to in/out

```
shell@rsb4680:/ $ echo "out" > /sys/class/gpio/gpio219/direction
```

Set GPIO value 0/1 if GPIO pin define is output

```
shell@rsb4680:/ $ echo 1 > /sys/class/gpio/gpio219/value
```

Used as IRQ signal

Note: You have to configure GPIO to input

```
shell@rsb4680:/ $ echo "rising" > /sys/class/gpio/gpio219/edge
NOTE: rising: Trigger on rising edge
        falling: Trigger on falling edge
        both: Trigger on both edges
        none: Disable interrupt on both edges
```

Unexport GPIO0

```
shell@rsb4680:/ $ echo 219 > /sys/class/gpio/unexport
```

GPIO 219 and GPIO 220 are taken as an example:

Connect GPIO 219 and GPIO 220

Export GPIO 219 and GPIO 220

```
shell@rsb4680:/ $ echo 219 > /sys/class/gpio/export
shell@rsb4680:/ $ echo 220 > /sys/class/gpio/export
```

Set GPIO 219 to output

```
shell@rsb4680:/ $ echo "out" > /sys/class/gpio/gpio219/direction
```

Set GPIO 220 to input

```
shell@rsb4680:/ $ echo "in" > /sys/class/gpio/gpio220/direction
```

Change GPIO 219 to 1 and read GPIO 220 value

```
shell@rsb4680:/ $ echo 1 > /sys/class/gpio/gpio219/value
shell@rsb4680:/ $ cat /sys/class/gpio/gpio220/value
1
```

Change GPIO 219 to 0 and read GPIO 220 value

```
shell@rsb4680:/ $ echo 0 > /sys/class/gpio/gpio219/value
shell@rsb4680:/ $ cat /sys/class/gpio/gpio220/value
0
```

3.4 UART

The Android/Linux UART/serial port access from the user is through the tty-devices. The tty-devices have different names depending on UART drivers on different board. RS-485 uses half-duplex communication, which means that one medium is shared for transmitting and receiving data. Therefore the system needs to control the RS-485 transceiver's transmit mode. Usually the UART RTS signal is used to switch the transmitter on and off.

| COM Name | Device Node | Remark |
|----------|--------------|------------------|
| UART0 | /dev/ttyS0 | for BT Data |
| COM1 | /dev/ttyS1 | |
| COM2 | /dev/ttyS2 | Debug Port/RS232 |
| COM3 | /dev/ttyS3 | |
| COM4 | /dev/ttyS4 | Support RS485 |
| COM6 | /dev/ttyUSB0 | USB to UART |
| COM7 | /dev/ttyUSB1 | USB to UART |

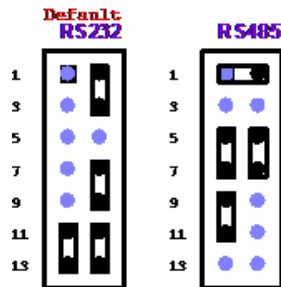

The COM2 defaults to the debug console, which can be switched to RS232 by pin-header, short circuit CN18 1 and 3.

| | |
|--------------------------|------------|
| COM | CN18 (1-3) |
| CONSOLE | CN18 (3-5) |
| COM4 RS485 Impedance On | CN18 (4-6) |
| COM4 RS485 Impedance Off | CN18 (2-4) |

3.5 Audio

Launch "Sound Recorder" for MIC

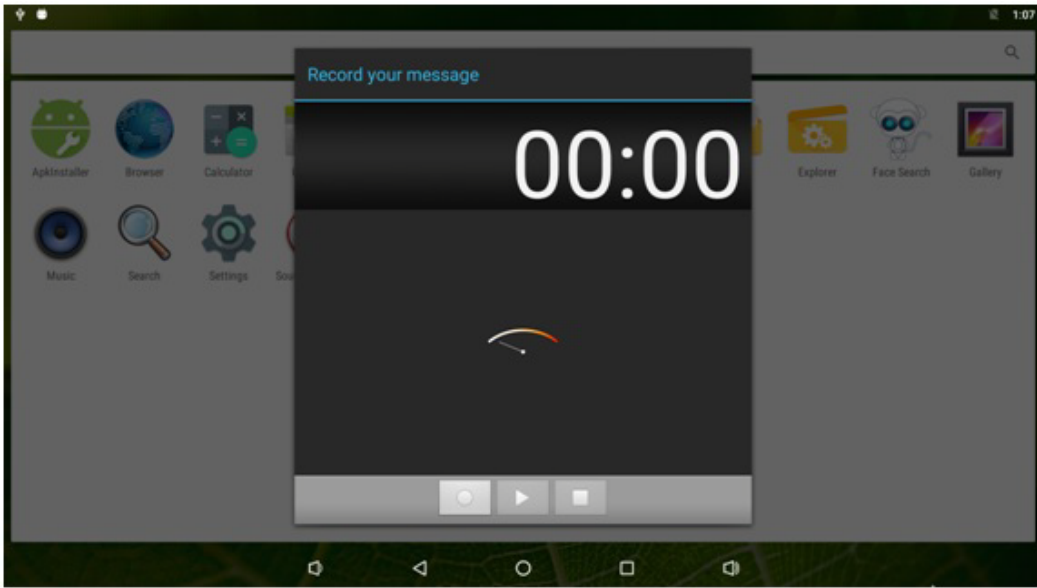

Launch "Video" for Audio



3.6 SD/MMC Card

3.6.1 Browse the SD

Android 6 Marshmallow also includes a built-in file manager feature to browse the SD card.

- Launch the Settings app
- Tap on Storage & USB
- Tap on SD card to explore the files

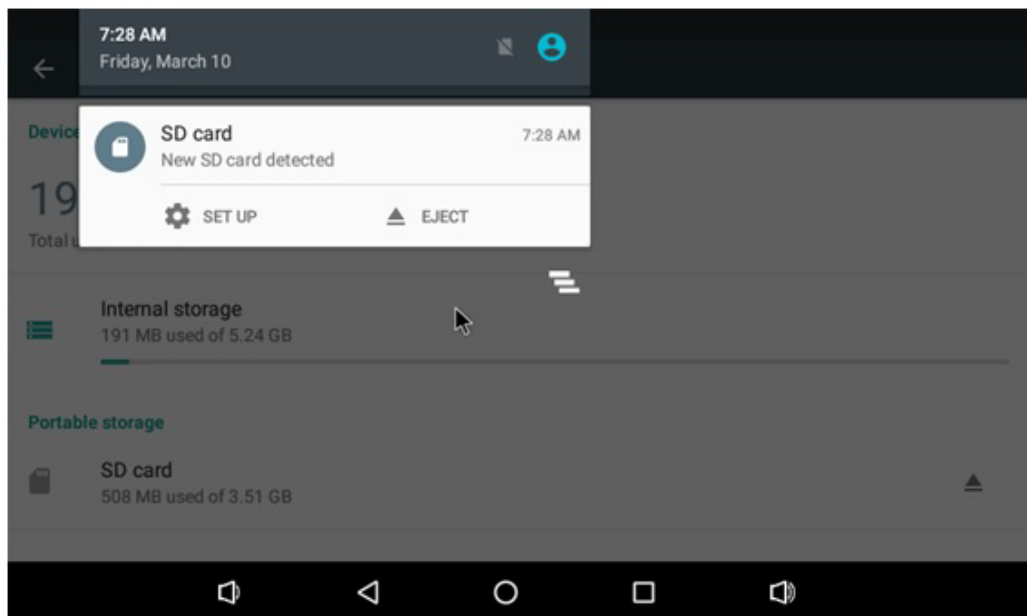
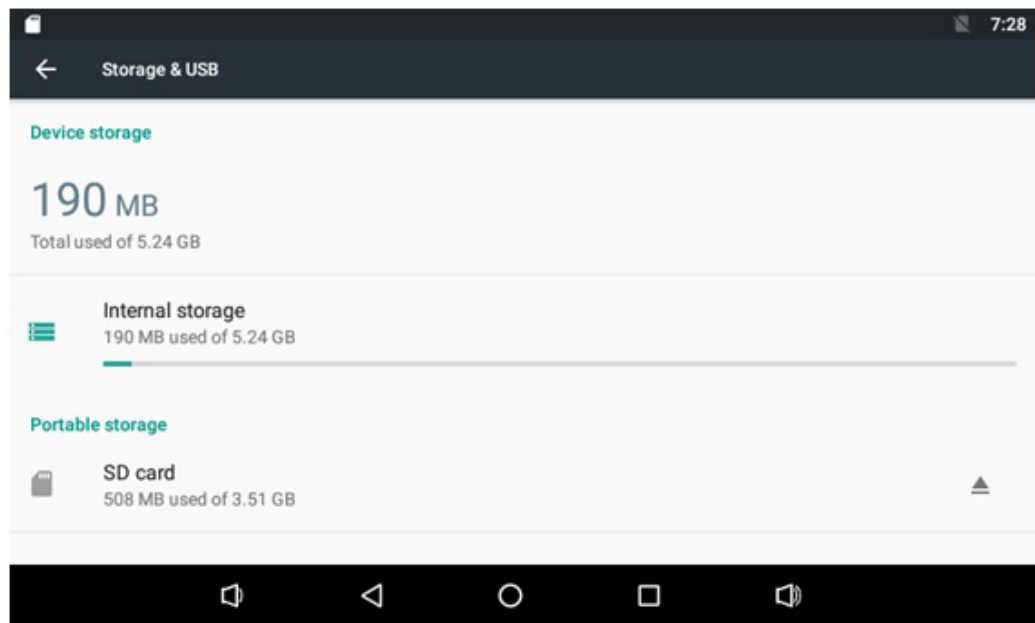

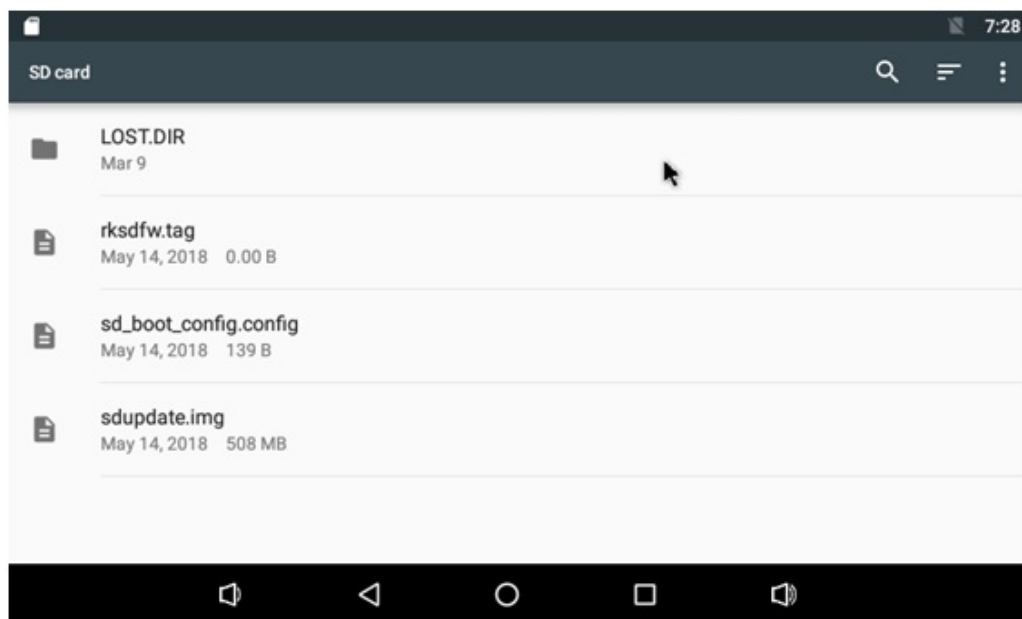

3.7 USB DISK

3.7.1 USB Disk Status

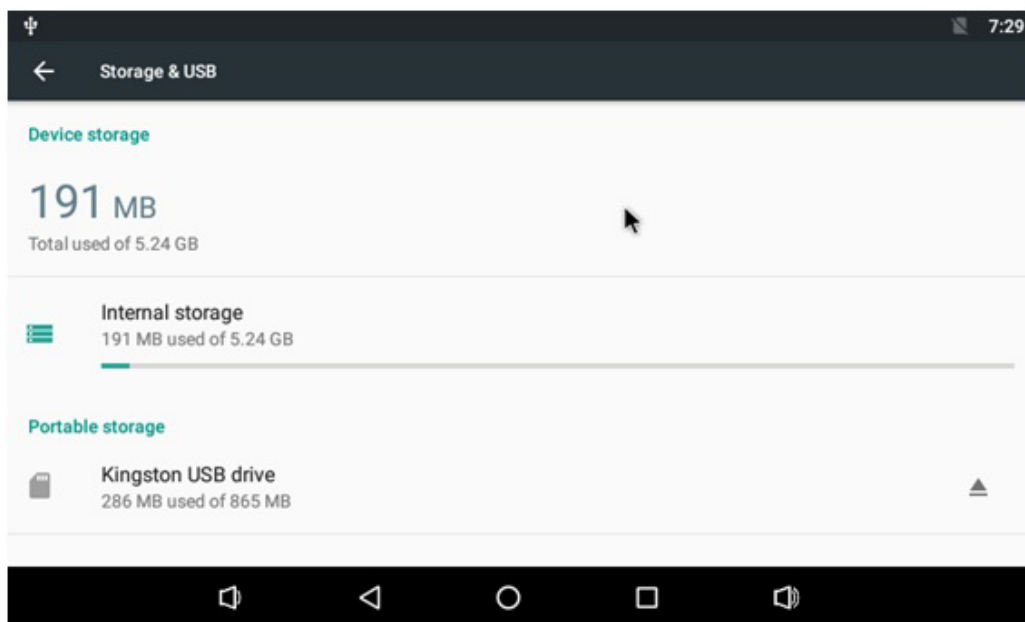

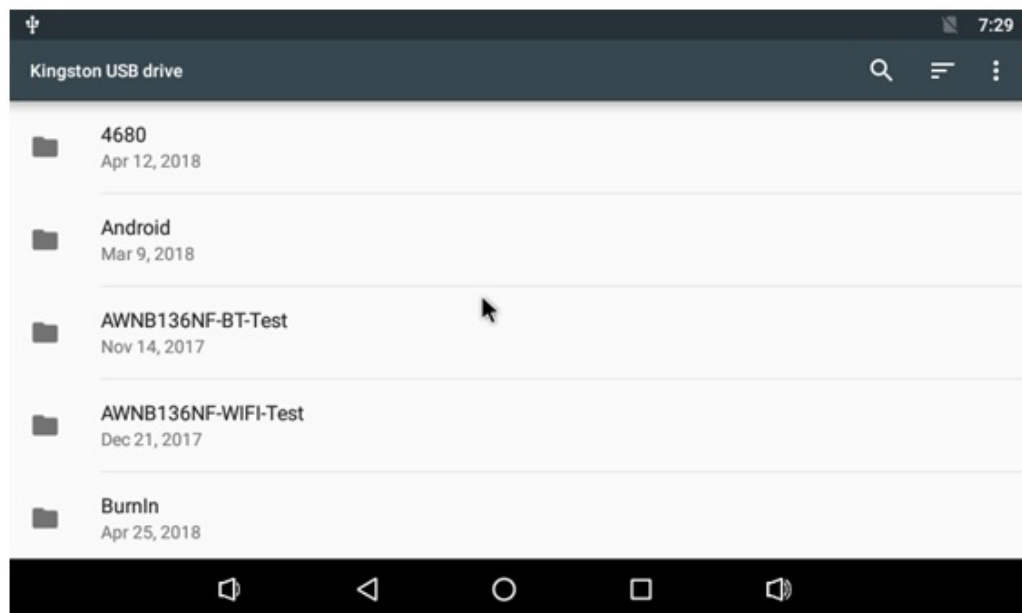
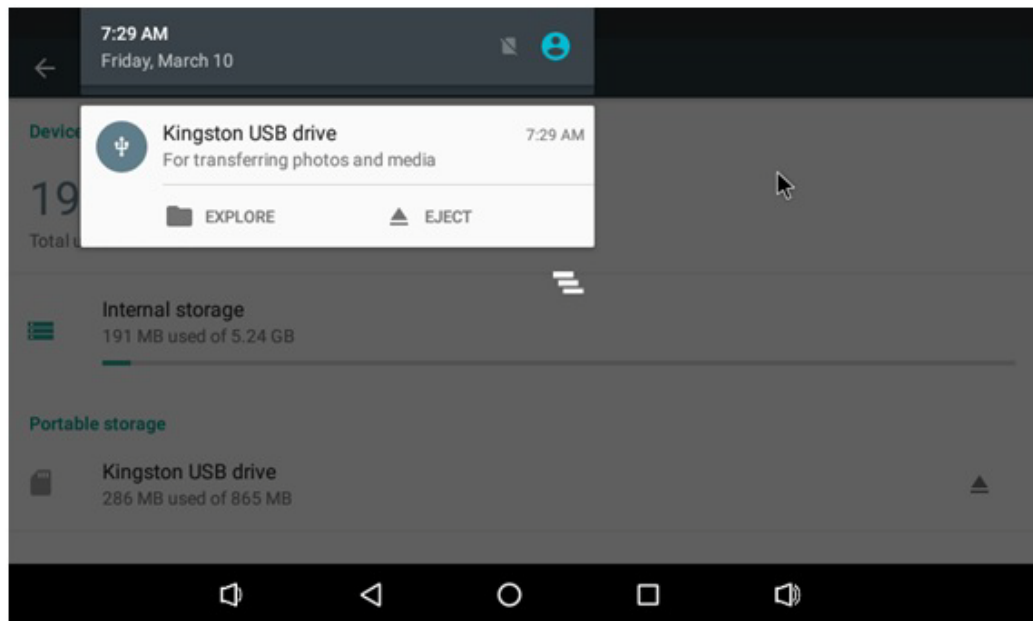

3.8 HDMI

3.8.1 HDMI Resolution

Starting Android, Entry Settings->HDMI->HDMI Resolution

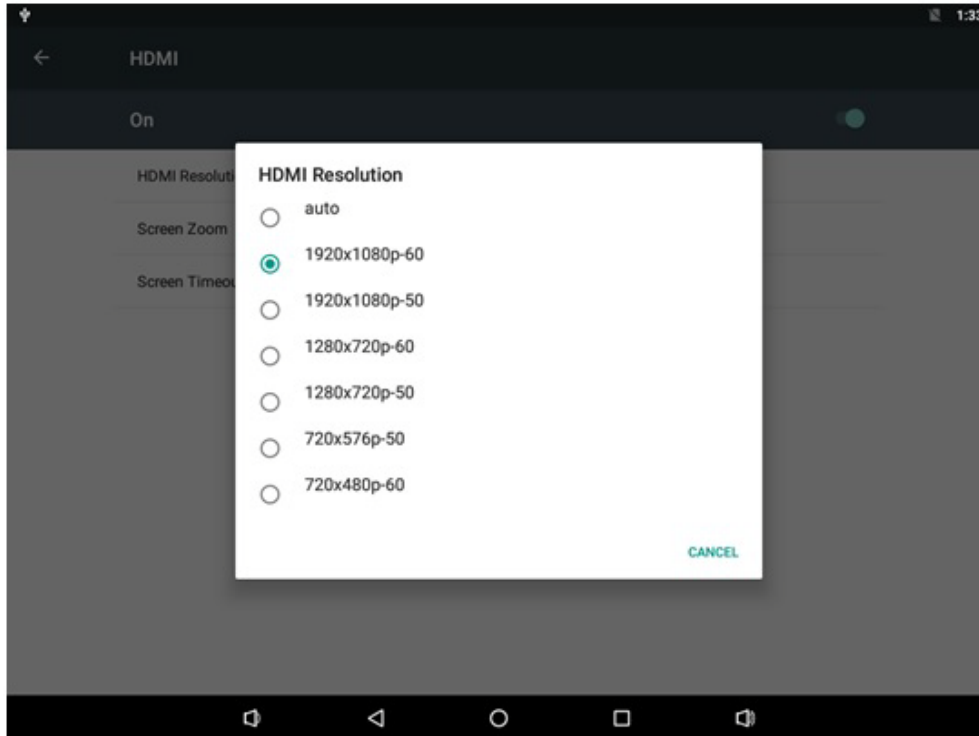

Note! RSB-4680 supports HDMI 2.0, the max resolution can up to 3840 x 2160@ 60Hz



Monitor Model:

Acer S277HK

Samsung UA55KU6310JXXZ

3.8.2 HDMI Audio

When HDMI monitor supports audio, the default output is from HDMI audio only
The following settings are set to open the other audio together

Power on, Starting in Android:

```
shell@rsb4680:/ $ su
root@rsb4680:/ # setprop persist.dual.audio true
root@rsb4680:/ # reboot
```

3.9 Multi-Display

Please set environment in u-boot as below

3.9.1 VGA(edp) and HDMI(4K)

1. VGA is main display, please set in u-boot as below:

```
rkboot # setenv pmry_screen edp-1024x768
rkboot # setenv extend_screen hdmi-720p
```

Note! This is the default setting.



2. HDMI is main display, please set in u-boot as below:

```
rkboot # setenv pmry_screen hdmi-720p
rkboot # setenv extend_screen edp-1024x768
```

3.9.2 HDMI(4K) and LVDS

1. HDMI is main display, please set in u-boot as below:

```
rkboot # setenv pmry_screen hdmi-720p
rkboot # setenv extend_screen lvds-g070vw01
```

2. LVDS is main display, please set in u-boot as below:

```
rkboot # setenv pmry_screen lvds-g070vw01
rkboot # setenv extend_screen hdmi-720p
```

3.9.3 LVDS and VGA (edp)

1. LVDS is main display, please set in u-boot as below:

```
rkboot # setenv pmry_screen lvds-g070vw01
rkboot # setenv extend_screen edp-1024x768
```

2. VGA is main display, please set in u-boot as below:

```
rkboot # setenv pmry_screen edp-1024x768
rkboot # setenv extend_screen lvds-g070vw01
```

- **LVDS optional:** lvds-g070vw01 (800*480), vds-g150xgel05 (1024*768), lvds-g215hvn01 (1920*1080 dual), lvds-p460hvn02 (1920*1080 dual 30bits), lvds-lmt101dnmfdd (1024*600), lvds-lmt150dngfdd (1024*768)
- **HDMI optional:** hdmi-720p?hdmi-1080p
- **VGA(edp) optional:** edp-1024x768, edp-1920x1080, edp-1920x1200

3.10 Network Setup

3.10.1 WIFI

1. Click Settings

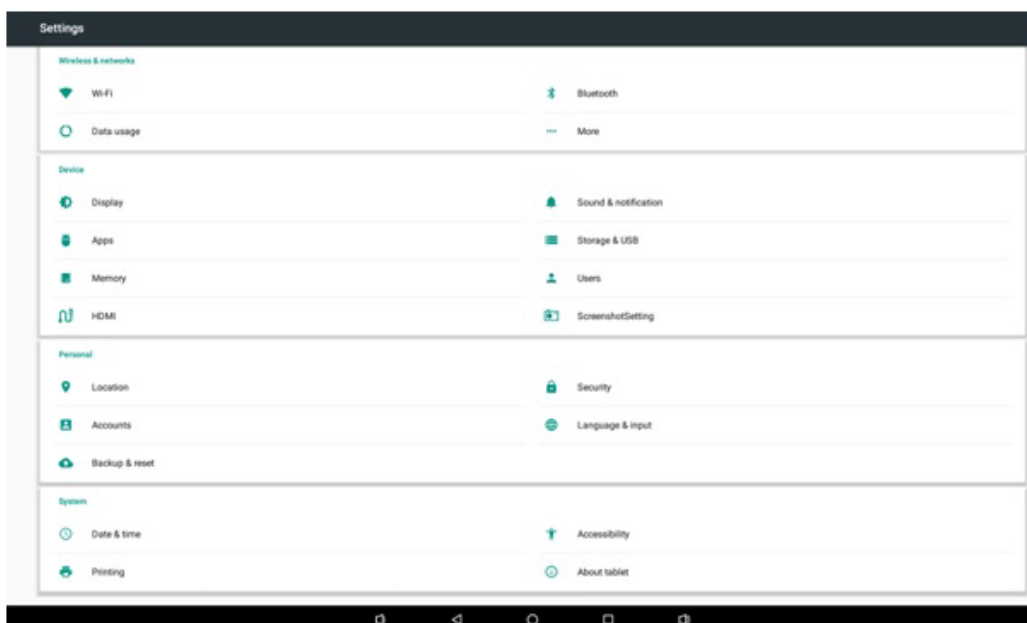

2. Turn on Wi-Fi

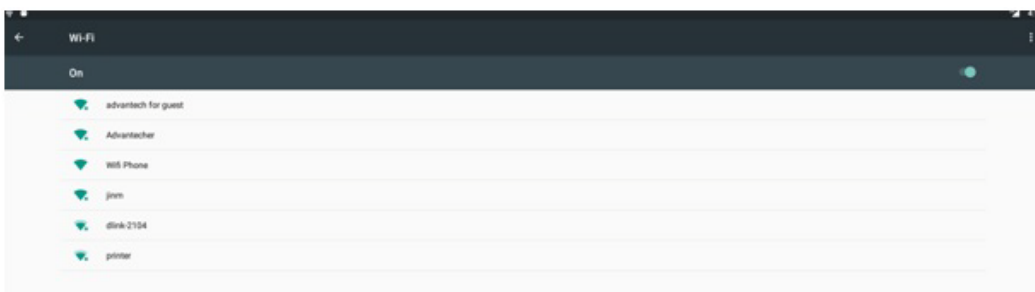

3. Choose ESSID (for example, Advantech for guest)

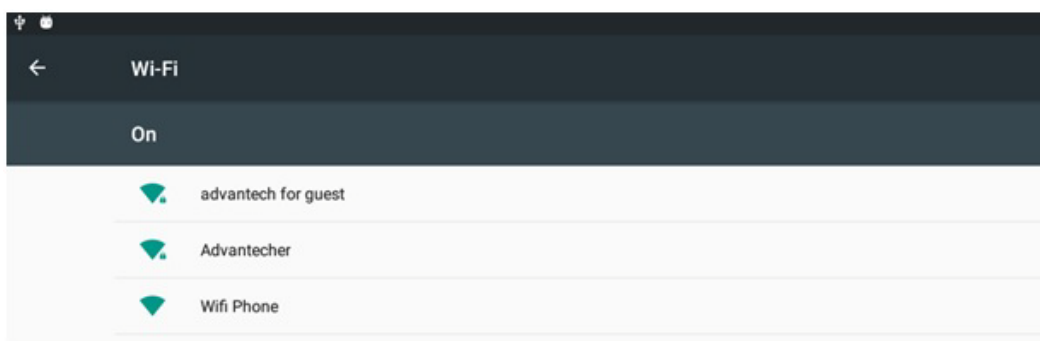

4. Input correct password

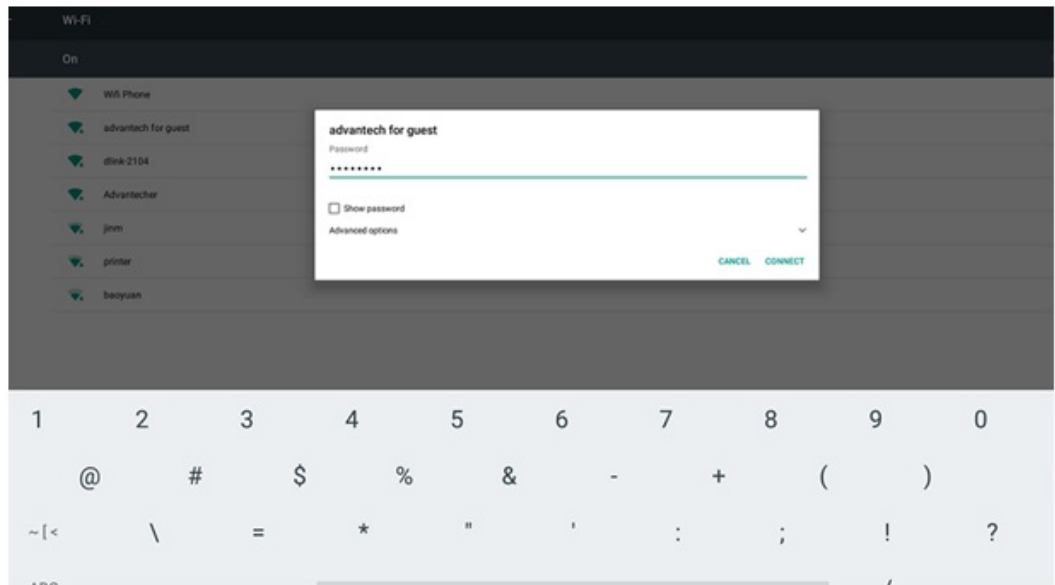

5. Wi-Fi connected

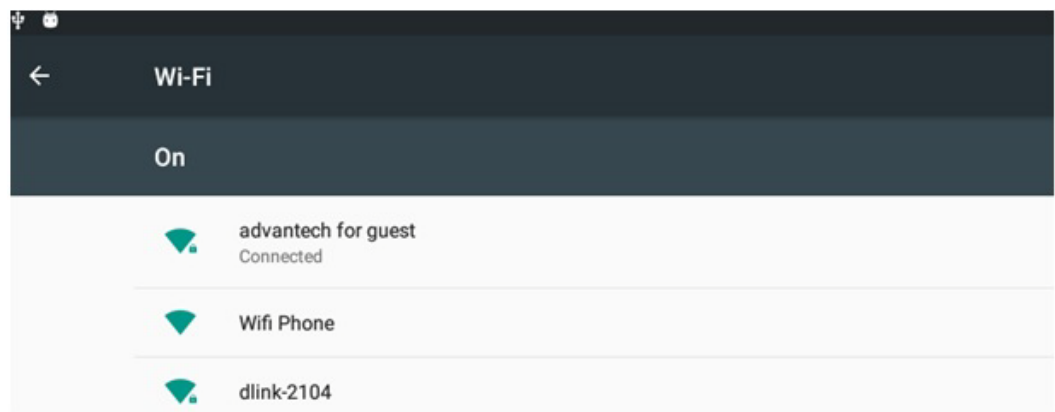

3.10.2 BT

1. Click Settings, switch the Bluetooth switch to ON to turn on Bluetooth:

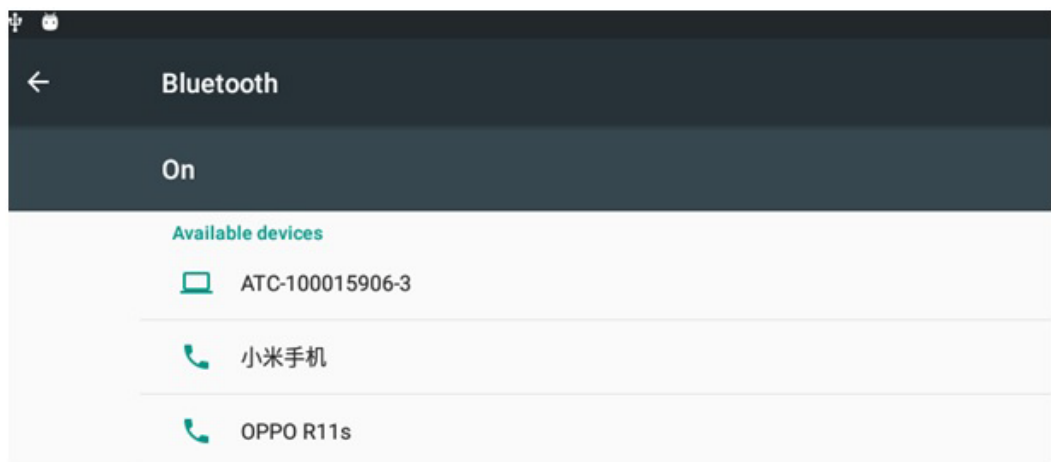

2. Click any available devices to pair with
3. After pairing successfully you can now communicate

3.10.3 3G/4G

1. Insert SIM card, restart
2. If you can't connect to the network, please check the following settings:
 - A. Settings/More/Cellular networks/ Access Point Names, then Correct

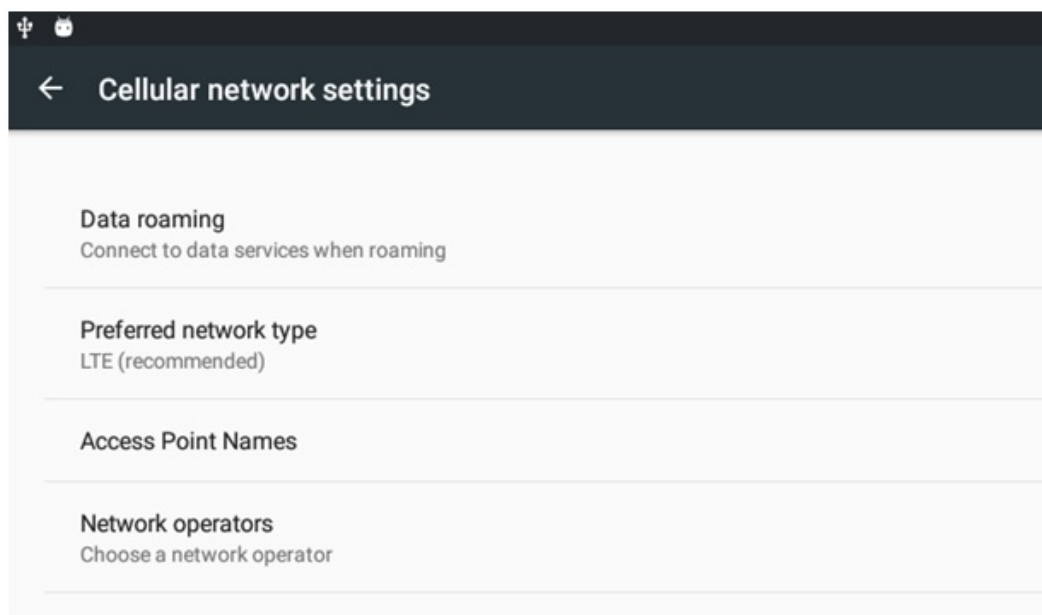
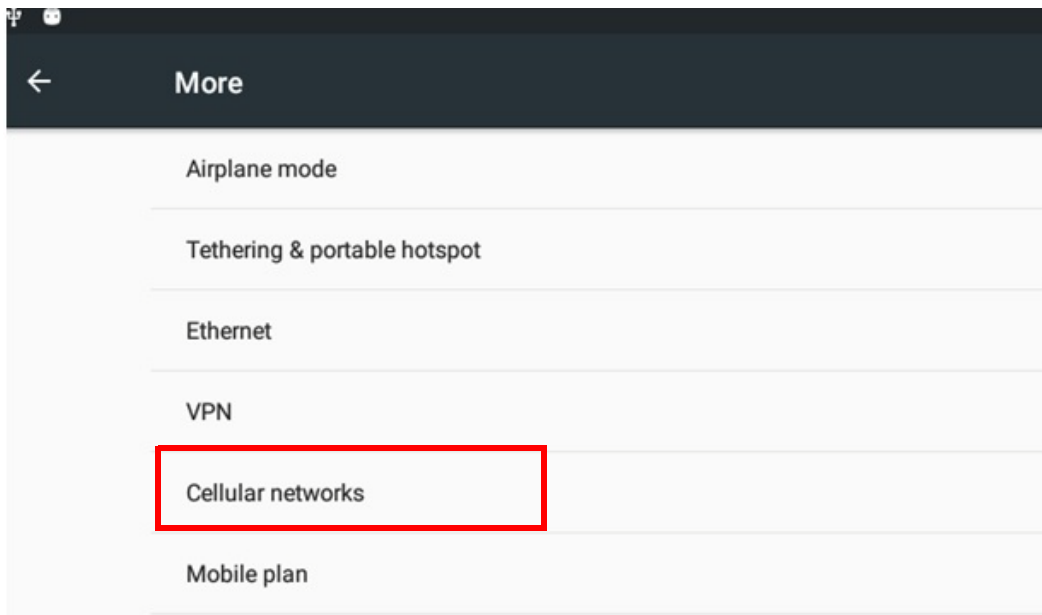

3.10.4 Ethernet

1. Click Settings Settings->More->Ethernet Configure Ethernet
There are two of IP setting: DHCP IP and static IP
DHCP IP - configuration is controlled by system

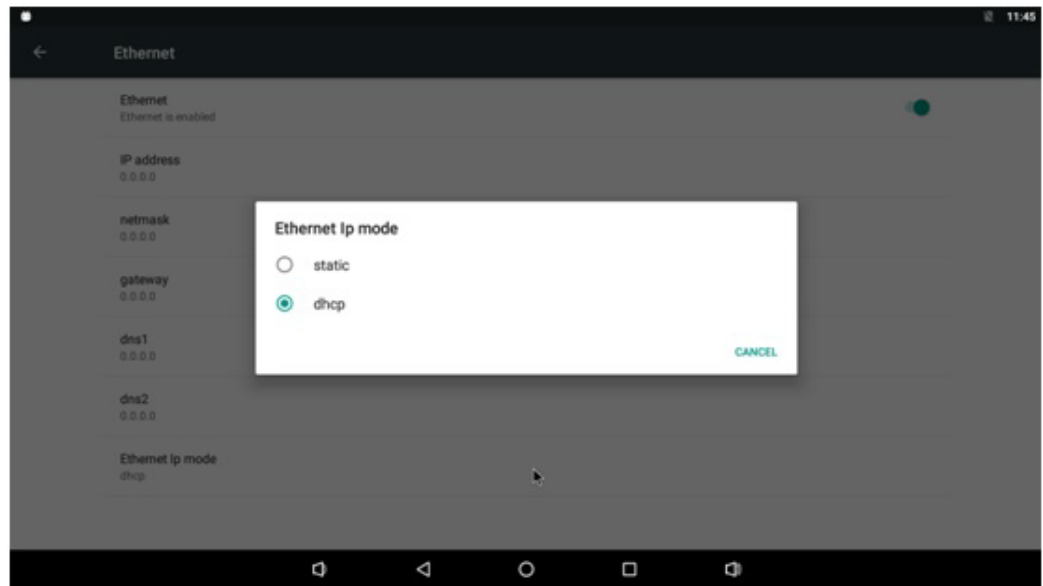

Static IP - There are five fields need to be filled: IP Address, netmask ,getway dns1 and dns2

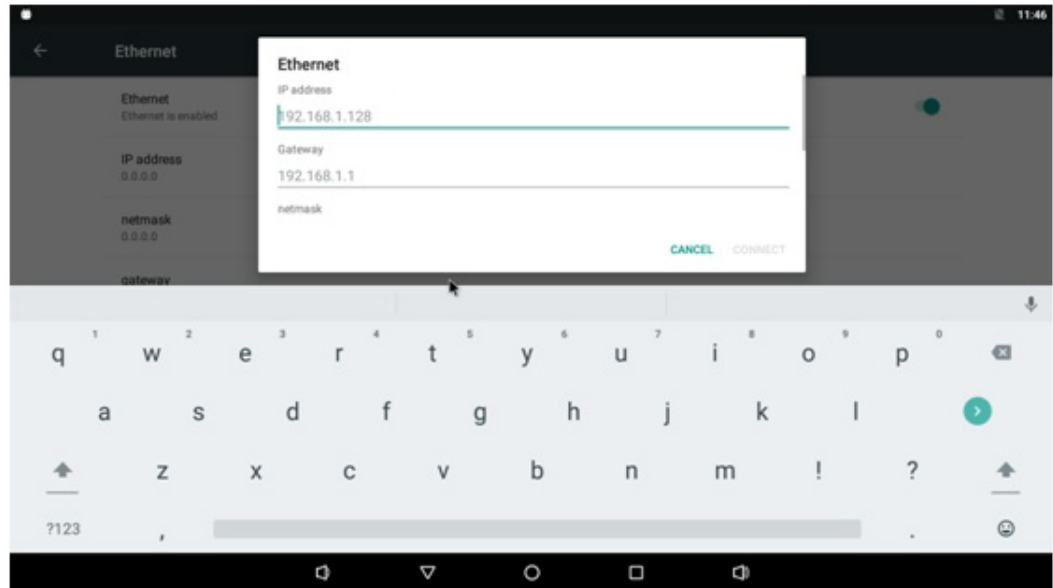

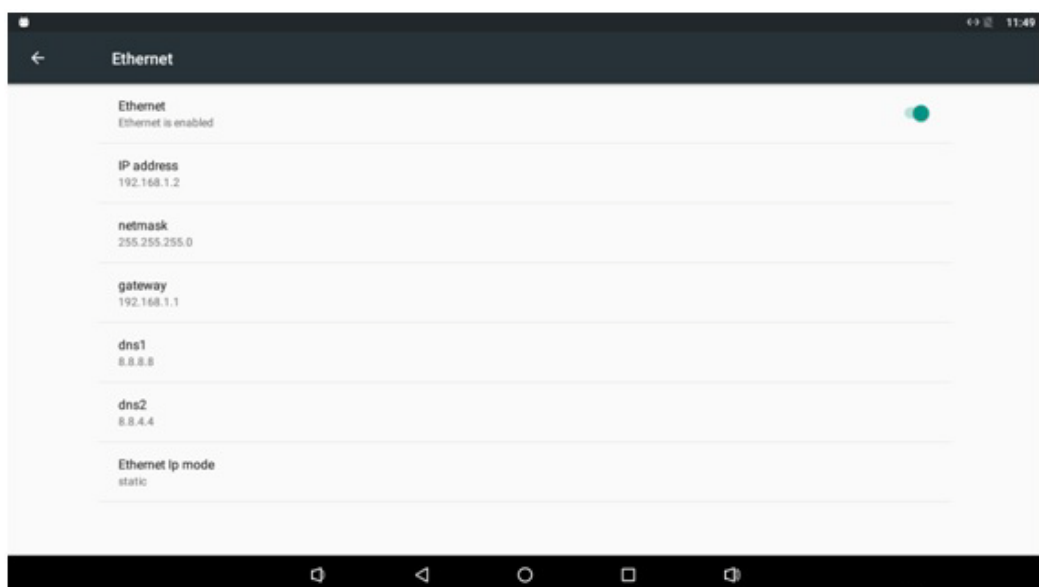
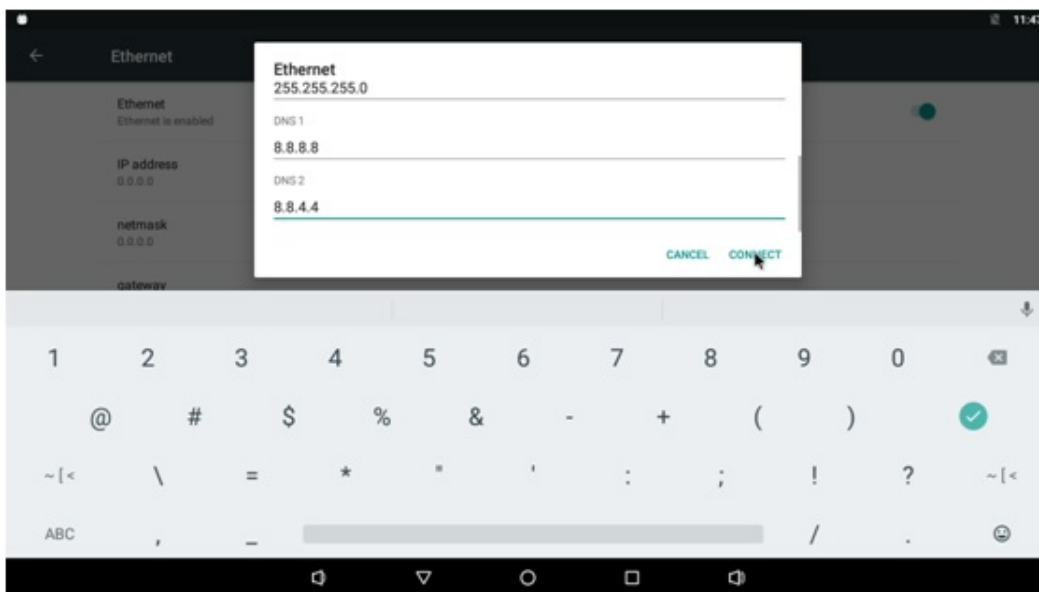

Chapter 4

Advantech Services

This chapter introduces Advantech design in serviceability, technical support, and warranty policy for RSB-4680 evaluation kit

4.1 RISC Design-In Services

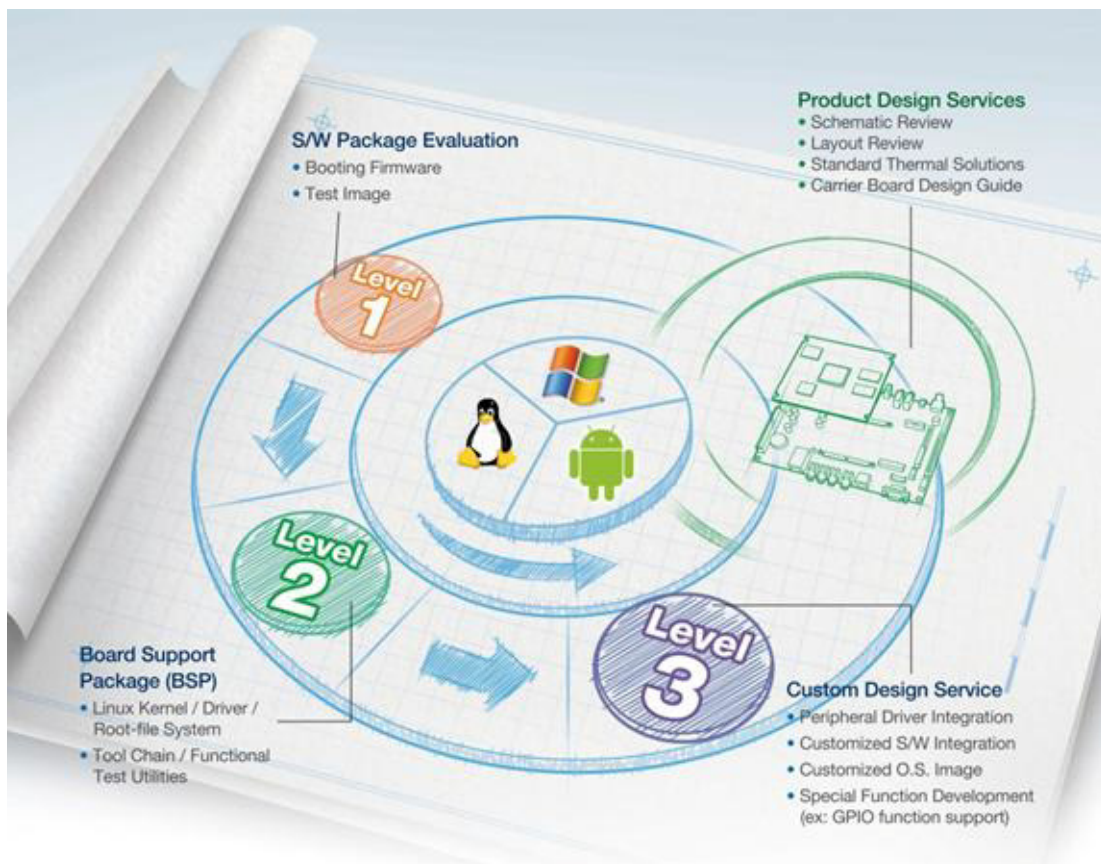

Advantech RISC Design-in Services help customers reduce time and work involved with designing new carrier boards. We handle the complexities of technical research and minimize the development risk associated with carrier boards.

Easy Development

Advantech has support firmware, root file-system, BSP or other develop tools for customers. It helps customers to easy develop their carrier board and differentiate their embedded products and applications.

- Full Range of RISC Product Offerings
- Comprehensive Document Support

Design Assistance Service

Advantech provides check list for engineers for easily checking their schematics and also reviewing service based on customer carrier board schematics. Those services are preventative and help to catch design errors before they happen. It helps save on time and costs with regard to developing carrier boards.

- Schematic Review
- Placement and Layout Review
- Debugging Assistance Services
- General/Special Reference Design Database.

Thermal Solution Services

In order to provide quicker and more flexible solutions for customer's thermal designs, Advantech provides thermal solution services, including modularized thermal solutions and customized thermal solutions.

- Standard Thermal Solutions
- Customized Thermal Solutions

Embedded Software Services

Supports driver, software integration or customized firmware, root file-systems, and Linux images so customers can save time, focus on core development.

- Embedded Linux/ Android OS
- Advantech Boot Loader Customization

With the spread of industrial computing, a whole range of new applications have been developed, resulting in a fundamental change in the IPC industry. In the past System Integrators (SI) were used to completing projects without outside assistance but now such working models have moved on. Due to diverse market demands and intense competition, cooperation for (both upstream and downstream) vertical integration has become a much more effective way to create competitive advantages. As a result, ARM-based CPU modules were born out of this trend. Concentrating all necessary components on the CPU module and placing other parts on the carrier board in response to market requirements for specialization provides greater flexibility while retaining low power consumption credentials.

Advantech has been involved in the industrial computer industry for many years and found that customers usually have the following questions when implementing modular designs.

General I/O Design Capabilities

Although customers possess the ability for vertical integration and have enough know-how and core competitiveness in the professional application field, the lack of expertise and experience in general power and I/O design causes many challenges, especially when integrating CPU modules into carrier board.

The Acquisition of Information

Even if the individual client is able to obtain sufficient information to make the right decision for the specialized vertical application, some customers encounter difficult problems dealing with platform design in general and communicating with CPU or chipset manufacturers, thereby increasing carrier board design difficulties and risk as well as seriously impacting time-to-market and losing market opportunities.

Software Development and Modification

Compared to x86 architectures, RISC architectures use simpler instruction sets. The software supports x86 platforms cannot be used on RISC platforms. System integrators need to develop software for their system and do the hardware and software integration themselves. Unlike x86 platforms, RISC platforms have less support for Board Support Packages (BSP) and drivers as well. Even though driver support is provided, SIs still have to make a lot of effort to integrate it into the system core. Moreover, the BSP provided by CPU manufacturers are usually for carrier board design, so it's difficult for SIs to have an environment for software development.

In view of this, Advantech proposed the concept of Streamlined Design-in Support Services for RISC-based Computer On Modules (COM). With a dedicated profes-

sional design-in services team, Advantech actively participates in carrier board design and problem solving. Our services not only enable customers to effectively distribute their resources but also reduce R&D manpower cost and hardware investment.

By virtue of a close interactive relationship with leading original manufacturers of CPUs and chipsets such as ARM, TI and Freescale, Advantech helps solve communication and technical support difficulties to reduce the uncertainties of product development. Advantech's professional software team also focuses on providing a complete Board Support Package and assists customers to build up a software development environment for their RISC platforms.

Advantech RISC design-in services helps customers overcome their problems to achieve the most important goal of faster time-to-market through a streamlined RISC Design-in service.

Along with our multi-stage development process which includes: planning, design, integration, and validation, Advantech's RISC design-in service provides comprehensive support to the following different phases:

Planning Stage

Before deciding to adopt Advantech RISC COM, customers must go through a complete survey process, including product features, specification, and compatibility testing with software. Advantech offers a RISC Customer Solution Board (CSB) as an evaluation tool for carrier boards which are simultaneously designed when developing RISC COMs. In the planning stage, customers can use this evaluation board to assess RISC modules and test peripheral hardware. What's more, Advantech provides standard software Board Support

Package (BSP) for RISC COM lets customers define their product's specifications as well as verifying I/O and performance at the same time. It offers hardware planning and technology consulting, but also software evaluation and peripheral module recommendations (such as WiFi, 3G, BT). Resolving customer concerns is Advantech's main target at this stage. Since we all know that product evaluation is the key task in the planning period, especially for performance and specification, so we try to help our customers conduct all the necessary tests for their RISC COM.

Design Stage

When a product moves into the design stage, Advantech will supply a design guide of the carrier board for reference. The carrier board design guide provides pin definitions of the COM connector with limitations and recommendations for carrier board design, so customers can have a clear guideline to follow during their carrier board development. Regarding different form factors, Advantech offers a complete pin-out check list for different form factors such as Q7, ULP and RTX2.0, so that customers can examine the carrier board signals and layout design accordingly. In addition, our team is able to assist customers to review the placement/layout and schematics to ensure the carrier board design meets their full requirements. For software development, Advantech RISC software team can assist customers to establish an environment for software development and evaluate the amount of time and resources needed. If customers outsource software development to a 3rd party, Advantech can also cooperate with the 3rd party and provide proficient consulting services. With Advantech's professional support, the design process becomes much easier and product quality will be improved to meet targets.

Integration Stage

This phase comprises HW/SW integration, application development, and peripheral module implementation. Due to the lack of knowledge and experience on platforms,

customers need to spend a certain amount of time on analyzing integration problems. In addition, peripheral module implementation has a lot to do with driver designs on carrier boards, RISC platforms usually have less support for ready-made drivers on the carrier board. Therefore, the customer has to learn from trial and error and finally get the best solution with the least effort. Advantech's team has years of experience in customer support and HW/SW development knowledge. Consequently, we can support customers with professional advice and information as well as shortening development time and enabling more effective product integration.

Validation Stage

After customer's ES sample is completed, the next step is a series of verification steps. In addition to verifying a product's functionality, the related test of the product's efficiency is also an important part at this stage especially for RISC platforms.

As a supportive role, Advantech primarily helps customers solve their problems in the testing process and will give suggestions and tips as well. Through an efficient verification process backed by our technical support, customers are able to optimize their applications with less fuss. Furthermore, Advantech's team can provide professional consulting services about further testing and equipment usage, so customers can find the right tools to efficiently identify and solve problems to further enhance their products quality and performance.

4.2 Contact Information

Below is the contact information for Advantech customer service.

| Region/Country | Contact Information |
|-----------------------|--|
| America | 1-888-576-9688 |
| Brazil | 0800-770-5355 |
| Mexico | 01-800-467-2415 |
| Europe (Toll Free) | 00800-2426-8080 |
| Singapore & SAP | 65-64421000 |
| Malaysia | 1800-88-1809 |
| Australia (Toll Free) | 1300-308-531 |
| China (Toll Free) | 800-810-0345 800-810-8389 Sales@advantech.com.cn |
| India (Toll Free) | 1-800-425-5071 |
| Japan (Toll Free) | 0800-500-1055 |
| Korea (Toll Free) | 080-363-9494 080-363-9495 |
| Taiwan (Toll Free) | 0800-777-111 |
| Russia (Toll Free) | 8-800-555-01-50 |

On the other hand, you can reach our service team through below website, our technical support engineer will provide quick response once the form is filled out:

http://www.advantech.com.tw/contact/default.aspx?page=contact_form2&subject=Technical+Support

4.3 Global Service Policy

4.3.1 Warranty Policy

Below is the warranty policy of Advantech products:

4.3.1.1 Warranty Period

Advantech branded off-the-shelf products and 3rd party off-the-shelf products used to assemble Advantech Configure to Order products are entitled to a 2 years complete and prompt global warranty service. Product defect in design, materials, and workmanship, are covered from the date of shipment.

All customized products will by default carry a 15 months regional warranty service. The actual product warranty terms and conditions may vary based on sales contract.

All 3rd party products purchased separately will be covered by the original manufacturer's warranty and time period, and shall not exceed one year of coverage through Advantech.

4.3.1.2 Repairs under Warranty

It is possible to obtain a replacement (Cross-Shipment) during the first 30 days of the purchase, thru your original ADVANTECH supplier to arrange DOA replacement if the products were purchased directly from ADVANTECH and the product is DOA (Dead-on-Arrival). The DOA Cross-Shipment excludes any shipping damage, customized and/or build-to-order products.

For those products which are not DOA, the return fee to an authorized ADVANTECH repair facility will be at the customers' expense. The shipping fee for reconstructive products from ADVANTECH back to customers' sites will be at ADVANTECH's expense.

4.3.1.3 Exclusions from Warranty

The product is excluded from warranty if

- The product has been found to be defective after expiry of the warranty period.
- Warranty has been voided by removal or alternation of product or part identification labels.
- The product has been misused, abused, or subjected to unauthorized disassembly/modification; placed in an unsuitable physical or operating environment; improperly maintained by the customer; or failure caused which ADVANTECH is not responsible whether by accident or other cause. Such conditions will be determined by ADVANTECH at its sole unfettered discretion.
- The product is damaged beyond repair due to a natural disaster such as a lightning strike, flood, earthquake, etc.
- Product updates/upgrades and tests upon the request of customers who are without warranty.

4.3.2 Repair Process

4.3.2.1 Obtaining an RMA Number

All returns from customers must be authorized with an ADVANTECH RMA (Return Merchandise Authorization) number. Any returns of defective units or parts without valid RMA numbers will not be accepted; they will be returned to the customer at the customer's cost without prior notice.

An RMA number is only an authorization for returning a product; it is not an approval for repair or replacement. When requesting an RMA number, please access ADVANTECH's RMA web site: <http://erma.ADVANTECH.com.tw> with an authorized user ID and password.

You must fill out basic product and customer information and describe the problems encountered in detail in "Problem Description". Vague entries such as "does not work" and "failure" are not acceptable.

If you are uncertain about the cause of the problem, please contact ADVANTECH's Application Engineers (AE). They may be able to find a solution that does not require sending the product for repair.

The serial number of the whole set is required if only a key defective part is returned for repair. Otherwise, the case will be regarded as out-of-warranty.

4.3.2.2 Returning the Product for Repair

It's possible customers can save time and meet end-user requirements by returning defective products to any authorized ADVANTECH repair facility without an extra cross-region charge. It is required to contact the local repair center before offering global repair service.

It is recommended to send cards without accessories (manuals, cables, etc.). Remove any unnecessary components from the card, such as CPU, DRAM, and CF Card. If you send all these parts back (because you believe they may be part of the problem), please note clearly that they are included. Otherwise, ADVANTECH is not responsible for any items not listed. Make sure the "Problem Description" is enclosed.

European Customers that are located outside European Community are requested to use UPS as the forwarding company. We strongly recommend adding a packing list to all shipments. Please prepare a shipment invoice according to the following guidelines to decrease goods clearance time:

1. Give a low value to the product on the invoice, or additional charges will be levied by customs that will be borne by the sender
2. Add information "Invoice for customs purposes only with no commercial value" on the shipment invoice
3. Show RMA numbers, product serial numbers and warranty status on the shipment invoice
4. Add information about Country of origin of goods

In addition, please attach an invoice with RMA number to the carton, then write the RMA number on the outside of the carton and attach the packing slip to save handling time. Please also address the parts directly to the Service Department and mark the package "Attn. RMA Service Department".

All products must be returned in properly packed ESD material or anti-static bags. ADVANTECH reserves the right to return unrepaired items at the customer's cost if inappropriately packed.

Besides that, "Door-to-Door" transportation such as speed post is recommended for delivery, otherwise, the sender should bear additional charges such as clearance fees if Air-Cargo is adopted.

Should DOA cases fail, ADVANTECH will take full responsibility for the product and transportation charges. If the items are not DOA, but fail within warranty, the sender will bear the freight charges. For out-of-warranty cases, customers must cover the cost and take care of both outward and inward transportation.

4.3.2.3 Service Charges

The product is excluded from warranty if:

- The product is repaired after expiry of the warranty period
- The product is tested or calibrated after expiry of the warranty period, and a No Problem Found (NPF) result is obtained
- The product, though repaired within the warranty period, has been misused, abused, or subjected to unauthorized disassembly/modification; placed in an unsuitable physical or operating environment; improperly maintained by the customer; or failure caused which ADVANTECH is not responsible whether by accident or other cause. Such conditions will be determined by ADVANTECH at its sole unfettered discretion.
- The product is damaged beyond repair due to a natural disaster such as a lightning strike, flood, earthquake, etc
- Product updates and tests upon the request of customers who are without warranty

If a product has been repaired by ADVANTECH, and within three months after such a repair the product requires another repair for the same problem, ADVANTECH will do this repair free of charge. However, such free repairs do not apply to products which have been misused, abused, or subjected to unauthorized disassembly/modification; placed in an unsuitable physical or operating environment; improperly maintained by the customer; or failure caused which ADVANTECH is not responsible whether by accident or other cause.

Please contact your nearest regional service center for detail service quotation.

Before we start out-of-warranty repairs, we will send you a pro forma invoice (P/I) with the repair charges. When you remit the funds, please reference the P/I number listed under "Our Ref". ADVANTECH reserves the right to deny repair services to customers that do not return the DOA unit or sign the P/I. Meanwhile, ADVANTECH will scrap defective products without prior notice if customers do not return the signed P/I within 3 months.

4.3.2.4 Repair Report

ADVANTECH returns each product with a "Repair Report" which shows the result of the repair. A "Repair Analysis Report" is also provided to customers upon request. If the defect is not caused by ADVANTECH design or manufacturing, customers will be charged US\$60 or US\$120 for in-warranty or out-of-warranty repair analysis reports respectively.

4.3.2.5 Custody of Products Submitted for Repair

ADVANTECH will retain custody of a product submitted for repair for one month while it is waiting for return of a signed P/I or payment (A/R). If the customer fails to respond within such period, ADVANTECH will close the case automatically. ADVANTECH will take reasonable measures to stay in proper contact with the customer during this one month period.

4.3.2.6 Shipping Back to Customer

The forwarding company for RMA returns from ADVANTECH to customers is selected by ADVANTECH. Per customer requirement, other express services can be adopted, such as UPS, FedEx and etc. The customer must bear the extra costs of such alternative shipment. If you require any special arrangements, please indicate this when shipping the product to us.

ADVANTECH

Enabling an Intelligent Planet

www.advantech.com

Please verify specifications before quoting. This guide is intended for reference purposes only.

All product specifications are subject to change without notice.

No part of this publication may be reproduced in any form or by any means, electronic, photocopying, recording or otherwise, without prior written permission of the publisher.

All brand and product names are trademarks or registered trademarks of their respective companies.

© Advantech Co., Ltd. 2018