

User Manual

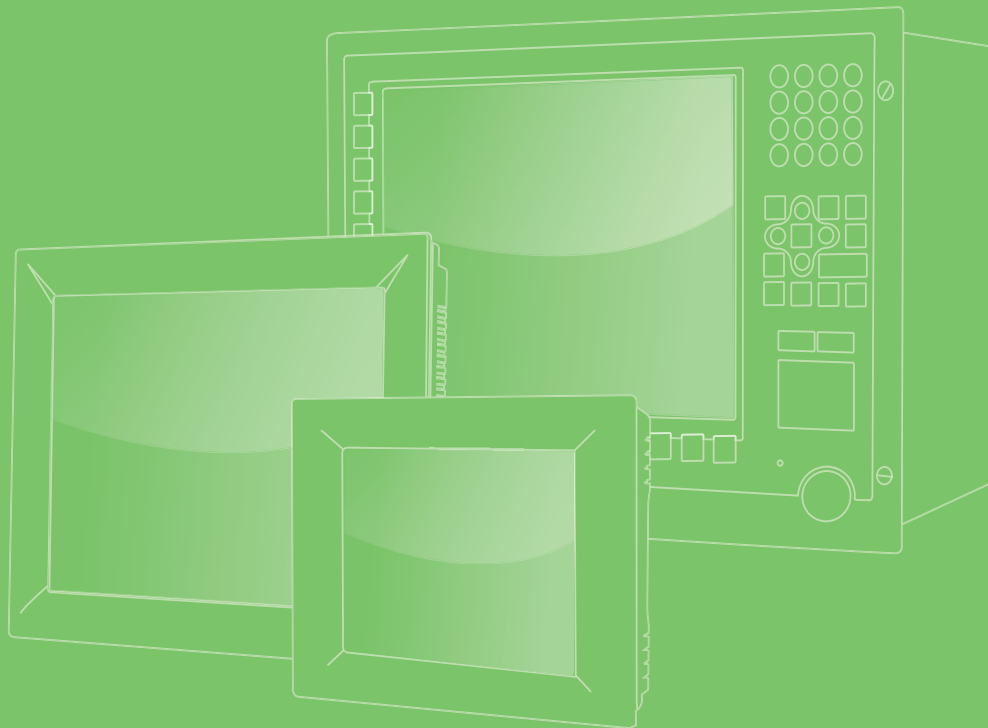

PPC-412

Intel® Core i Processor Based
Microcomputer, with 12.1" Color
TFT LCD Display

ADVANTECH

Enabling an Intelligent Planet

Copyright

The documentation and the software included with this product are copyrighted 2022 by Advantech Co., Ltd. All rights are reserved. Advantech Co., Ltd. reserves the right to make improvements in the products described in this manual at any time without notice. No part of this manual may be reproduced, copied, translated, or transmitted in any form or by any means without the prior written permission of Advantech Co., Ltd. The information provided in this manual is intended to be accurate and reliable. However, Advantech Co., Ltd. assumes no responsibility for its use, nor for any infringements of the rights of third parties that may result from its use.

Acknowledgments

Intel and Pentium are trademarks of Intel Corporation.

Microsoft Windows is registered trademark of Microsoft Corp.

All other product names or trademarks are properties of their respective owners.

Product Warranty (2 years)

Advantech warrants the original purchaser that each of its products will be free from defects in materials and workmanship for two years from the date of purchase.

This warranty does not apply to any products that have been repaired or altered by persons other than repair personnel authorized by Advantech, or products that have been subject to misuse, abuse, accident, or improper installation. Advantech assumes no liability under the terms of this warranty as a consequence of such events.

Because of Advantech's high quality-control standards and rigorous testing, most customers never need to use our repair service. If an Advantech product is defective, it will be repaired or replaced free of charge during the warranty period. For out-of-warranty repairs, customers will be billed according to the cost of replacement materials, service time, and freight. Please consult your dealer for more details.

If you believe your product to be defective, follow the steps outlined below.

1. Collect all the information about the problem encountered. (For example, CPU speed, Advantech products used, other hardware and software used, etc.) Note anything abnormal and list any onscreen messages displayed when the problem occurs.
2. Call your dealer and describe the problem. Please have your manual, product, and any helpful information readily available.
3. If your product is diagnosed as defective, obtain a return merchandise authorization (RMA) number from your dealer. This allows us to process your return more quickly.
4. Carefully pack the defective product, a completed Repair and Replacement Order Card, and a proof of purchase date (such as a photocopy of your sales receipt) into a shippable container. Products returned without a proof of purchase date are not eligible for warranty service.
5. Write the RMA number clearly on the outside of the package and ship the package prepaid to your dealer.

Declaration of Conformity

CE

This product has passed the CE test for environmental specifications when shielded cables are used for external wiring. We recommend the use of shielded cables. This type of cable is available from Advantech. Please contact your local supplier for ordering information.

Test conditions for passing also include the equipment being operated within an industrial enclosure. In order to protect the product from damage caused by electrostatic discharge (ESD) and EMI leakage, we strongly recommend the use of CE-compliant industrial enclosure products.

FCC Class B

This equipment has been tested and found to comply with the limits for a Class B digital device, pursuant to part 15 of the FCC Rules. These limits are designed to provide reasonable protection against harmful interference in a residential installation. This equipment generates, uses, and can radiate radio frequency energy and, if not installed and used in accordance with the instruction manual, may cause harmful interference to radio communications. However, there is no guarantee that interference will not occur in a particular installation. If this equipment does cause harmful interference to radio or television reception, which can be determined by turning the equipment off and on, the user is encouraged to try to correct the interference by one or more of the following measures:

- Reorient or relocate the receiving antenna.
- Increase the separation between the equipment and receiver.
- Connect the equipment into an outlet on a circuit different from that to which the receiver is connected.
- Consult the dealer or an experienced radio/TV technician for assistance.

Technical Support and Assistance

1. Visit the Advantech website at www.advantech.com/support to obtain the latest product information.
2. Contact your distributor, sales representative, or Advantech's customer service center for technical support if you need additional assistance. Please have the following information ready before calling:
 - Product name and serial number
 - Description of your peripheral attachments
 - Description of your software (operating system, version, application software, etc.)
 - A complete description of the problem
 - The exact wording of any error messages

Safety Instructions

1. Read these safety instructions carefully. Veuillez lire attentivement ce manuel d'instructions de sécurité.
2. Retain this user manual for future reference. Veuillez conserver ce manuel d'instructions pour référence ultérieure.
3. Disconnect the equipment from all power outlets before cleaning. Use only a damp cloth for cleaning. Do not use liquid or spray detergents. Débranchez l'appareil de toutes les prises de courant avant le nettoyage. Nettoyez-le uniquement à l'aide d'un chiffon humide. Ne pas utiliser de détergents liquides ou pulvérisateurs.
4. For pluggable equipment, the power outlet socket must be located near the equipment and easily accessible. Pour les appareils enfichables, la prise de courant doit être placée près de l'appareil et facilement accessible.
5. Protect the equipment from humidity. Protégez l'appareil contre l'humidité.
6. Place the equipment on a reliable surface during installation. Dropping or letting the equipment fall may cause damage. Placez l'appareil sur une surface fiable pendant l'installation. L'abandon ou la chute de l'appareil pourrait causer des dommages.
7. The openings on the enclosure are for air convection. Protect the equipment from overheating. Do not cover the openings. Les ouvertures du boîtier sont pour la convection d'air. Protégez l'appareil contre la surchauffe. Ne couvrez pas les ouvertures.
8. Ensure that the voltage of the power source is correct before connecting the equipment to a power outlet. The power outlet socket should have grounded connection. Assurez-vous que la tension de la source d'alimentation est correcte avant de connecter l'appareil à une prise de courant. La prise de courant doit avoir une bonne connexion mise à la terre.
9. Position the power cord away from high-traffic areas. Do not place anything over the power cord. Placez le cordon d'alimentation à l'écart des zones à fort trafic. Ne placez rien sur le cordon d'alimentation.
10. All cautions and warnings on the equipment should be noted. Attention à toutes les précautions et avertissements indiqués sur l'appareil.
11. If the equipment is not used for a long time, disconnect it from the power source to avoid damage from transient overvoltage. Si l'appareil n'est pas utilisé pendant une longue période, déconnectez-le de la source d'alimentation pour éviter les dommages causés par une surtension transitoire.
12. Never pour liquid into an opening. This may cause fire or electrical shock. Ne versez jamais de liquide dans une ouverture. Sinon, cela pourrait provoquer un incendie ou un choc électrique.
13. Never open the equipment. For safety reasons, the equipment should be opened only by qualified service personnel. N'ouvrez jamais l'appareil. Pour des raisons de sécurité, l'appareil ne doit être ouvert que par un technicien qualifié.
14. If any of the following occurs, have the equipment checked by service personnel: Si l'un des cas suivants se produit, demandez aide à un technicien qualifié:
 - The power cord or plug is damaged. Le cordon d'alimentation ou la fiche est endommagé.
 - Liquid has penetrated the equipment. Le liquide a pénétré dans l'appareil.
 - The equipment has been exposed to moisture. L'appareil a été exposé à l'humidité.
 - The equipment is malfunctioning or does not function according to the user manual. L'appareil est défectueux ou ne fonctionne pas conformément aux instructions.

- The equipment has been dropped or damaged. L'appareil a été abandonné et endommagé.
 - The equipment shows obvious signs of breakage.L'appareil montre des signes évidents de rupture.
15. Do not leave the equipment in an environment with a storage temperature of below -20° C (-4° F) or above 60° C (140° F) as this may cause damage. The equipment should be kept in a controlled environment. Ne laissez pas cet appareil dans un environnement dont la température de stockage est inférieure à -20° C (-4° F) ou supérieure à 60° C (140° F), car cela pourrait causer des dommages. L'appareil doit être surveillé dans l'environnement.
 16. CAUTION: Batteries are at risk of exploding if incorrectly replaced. Replace only with the same or equivalent type as recommended by the manufacturer. Discard used batteries according to the manufacturer's instructions. ATTENTION: Il y a danger d'explosion s'il y a remplacement incorrect de la pile. Remplacer uniquement avec une pile du même type ou d'un type équivalent recommandé par le constructeur.
 17. In accordance with the IEC 704-1:1982 specifications, the sound pressure level at the operator's position does not exceed 70 dB (A). Conformément aux spécifications de l'IEC 704-1:1982, le niveau de pression acoustique à la position de l'opérateur ne dépasse pas 70 dB (A).
 18. The product PPC-412 are intended to be supplied by an UL certified power supply (Adapter: FSP090-DIEBN2) suitable for use at Tma 40 degree C min. and output is rated 19Vdc, 4.74A min., ES1 (or SELV) or the product are intended to be supplied by an UL certified power supply or dc source suitable for use at Tma 50 degree C min. and output is rated 9-32Vdc, 7-2A min., ES1 (or SELV), if need further assistance, please contact Advantech for further information. Le produit PPC-412 doit être alimenté par une alimentation certifiée UL (Adaptateur: FSP090-DIEBN2) approprié pour l'utilisation à une température de 40°C au minimum, et la sortie nominale est 19Vdc, 4.74 A min., ES1 (ou SELV). Ou le produit doit être alimenté par une alimentation certifiée UL ou CC pour l'utilisation à une température de 50°C au minimum, et la sortie nominale est 9-32Vdc, 7-2A min., ES1 (ou SELV). Si vous avez besoin d'aide supplémentaire, veuillez contacter Advantech pour plus d'informations.
 19. DISCLAIMER: These instructions are provided in accordance with IEC 704-1 standards. Advantech disclaims all responsibility for the accuracy of any statements contained herein. AVERTISSEMENT: Ces instructions sont fournies conformément aux normes IEC 704-1. Advantech décline toute responsabilité quant à la précision de toute déclaration contenue dans le présent document.
 20. CAUTION: This product is not intended for use by children and is not suitable for use in locations where children are likely to be present (this product is not a toy). ATTENTION: Ce produit n'est pas un jouet et devrait être gardé hors de la portée des enfants.
 21. Please Keep the monitor out of direct sunlight, very strong bright lights and away from any other heat source. Lengthy exposure to this type of environment may result in discoloration and damage to the monitor.

Safety Precaution - Static Electricity

Follow these simple precautions to protect yourself from harm and the products from damage.

- To avoid electrical shock, always disconnect the power from the PC chassis before manual handling. Do not touch any components on the CPU card or other cards while the PC is powered on.
- Disconnect the power before making any configuration changes. A sudden rush of power after connecting a jumper or installing a card may damage sensitive electronic components.

Battery Information

Batteries, battery packs and accumulators should not be disposed of as unsorted household waste. Please use the public collection system to return, recycle, or treat them in compliance with the local regulations.



Contents

Chapter 1	General Information	1
1.1	Introduction	2
1.2	Key Features.....	2
1.3	Front Panel.....	2
	Figure 1.1 Front Panel.....	2
1.4	Rear Panel	3
	Figure 1.2 Rear Panel_PPC-412	3
1.5	Dimensions	3
	Figure 1.3 PPC-412 Dimensions	3
1.6	Specifications	4
1.7	Ordering Information	5
Chapter 2	System Installation & Setup	7
2.1	Quick Start Guide.....	8
	Figure 2.1 Front Panel	8
	Figure 2.2 Side View.....	8
	Figure 2.3 Location of I/O Interfaces	9
2.2	Installation Procedures.....	10
2.2.1	Connecting the Power Cable	10
	Figure 2.4 Connecting the Power Cable.....	10
2.2.2	Connecting the Keyboard and Mouse.....	11
2.2.3	Power ON	11
2.3	Install Memory Card.....	11
	Figure 2.5	11
	Figure 2.6	11
	Figure 2.7	11
	Figure 2.8	12
	Figure 2.9	12
2.4	Installing the SSD.....	13
	Figure 2.10.....	13
	Figure 2.11.....	14
	Figure 2.12.....	14
2.5	Installing M.2.....	15
	Figure 2.13.....	15
	Figure 2.14.....	15
	Figure 2.15.....	15
2.6	Installing Wireless LAN Card	16
	Figure 2.16.....	16
	Figure 2.17.....	16
	Figure 2.18.....	17
	Figure 2.19.....	17
	Figure 2.20.....	17
2.7	Installing TPM (current mechanism only supports 98R3P321110).....	18
	Figure 2.21.....	18
	Figure 2.22.....	18
2.8	AT/ATX Function Switch	19
	Figure 2.23ATX Mode.....	19
	Figure 2.24AT Mode	19
2.9	Grounding Installation	19
2.9.1	System Grounding Installation	19
	Figure 2.25.....	19
	Figure 2.26.....	19
	Figure 2.27.....	19

	Figure 2.28	19
2.9.2	Cabinet Installation and Grounding	20
	Figure 2.29 Cabinet Installation	20
	Figure 2.30 System Wiring Diagram	21
2.10	Hook Installation	22
	Figure 2.31 Hook Installation	22
Chapter 3	Jumper Configuration	23
3.1	Jumper & Connector	24
	Figure 3.1 PCM-8213 Front View	24
3.2	External COM Port Pin Definition	29
	Figure 3.2 COM Ports	29
Chapter 4	Software Configuration	31
4.1	Install Divers	32
4.2	BIOS Setup Program	32
4.2.1	Entering BIOS Setup	32
4.2.2	Adjustment of LCD Brightness	33
4.2.3	COM3 Mode Selection (RS422/RS485)	35
4.2.4	BIOS AT & ATX Setup	38
4.2.5	Wake on LAN or Ring	39
4.2.6	TPM Settings	40

Chapter 1

General Information

This chapter gives background information on the PPC-412 panel PC.

Sections include:

- Introduction
- Specifications
- Dimensions

1.1 Introduction

The PPC-412 is a new generation Panel PC with XGA (1024 x 768) screen. The system is equipped with a high performance Intel Core i CPU and with a high efficiency fanless thermal design in which the heat is easily dissipated. It has multiple I/O ports (five COM, five USB and two Gigabit ethernet) making more applications possible.

1.2 Key Features

- True-flat HD LCD panel with 5-wire Resistive touchscreen
- Intel® Core™ i5-7300U (default); i7-7600U/i3-7100U (optional) processor with fanless system design
- 1 x isolated RS-422/485 with auto flow
- Wide input power range (9 ~ 32 V_{DC})
- Dual Gigabit Ethernet with IEEE1588 support
- 3 x Independent displays
- 1 x M.2 bay (2242) for storage only
- 1 x TPM 2.0 internal support (optional)

1.3 Front Panel

The PPC-412 front panel is a true-flat color TFT LCD with resistive touch control and an IP65 rating for resistance to dust and water (Figure 1.1).



Figure 1.1 Front Panel

1.4 Rear Panel

The PPC-412 rear panel features four VESA mount holes (75 x 75 mm), as shown in Figure 1.2.



Figure 1.2 Rear Panel_PPC-412

1.5 Dimensions

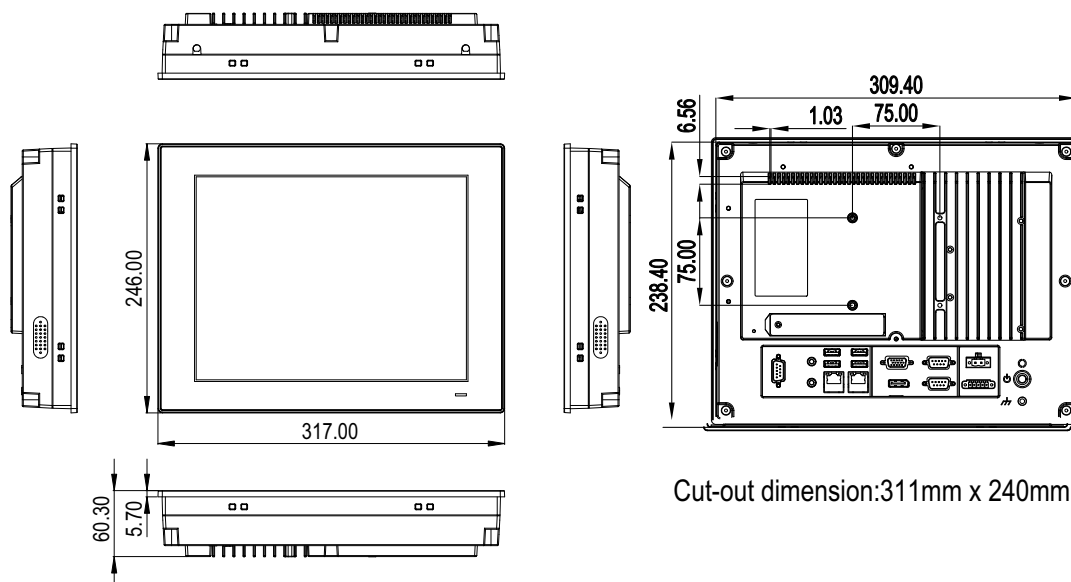

Figure 1.3 PPC-412 Dimensions

Note! Supports VESA 75 x 75mm. Use M4 screws, 8 mm depth (maximum). Use suitable mounting apparatus to avoid risk of injury.



1.6 Specifications

Product	PPC-412-R750A
LCD Display	12.1"
Display Type	12.1" TFT LCD (LED backlight)
Resolution Max.	1024 x 768
Luminance (cd/m2)	600
Viewing Angle	89 (left), 89 (right), 89 (up), 89 (down)
Contrast	1000
Backlight Lifetime	50,000 hr (min.)
Touchscreen Type	5-wire resistive
Light Transmission	80±5% at 550nm wavelength
Controller	USB interface
CPU	Intel® Core™ i5-7300U dual core (default); i7-7600U/i3-7100U (optional)
Memory	1 x SODIMM DDR4 1866/2133 MHz, (max. 16 GB)
Storage	1 x 2.5" SATA bay 1 x M.2 bay (size: 22 x 42 mm, socket 2 B key, for storage only)
Network (LAN)	2 x 10/100/1000 Mbps Ethernet (Intel® I211-AT; Intel® I219LM)
I/O Ports	4 x Serial ports (3 x RS-232, 1 x RS-422/485 with 1K VDC isolation) 4 x USB 3.0, 1 x Line-out, 1 x Mic-in 1 x DB15 VGA 1 x DisplayPort (1.2) 1 x TPM 2.0 internal (optional)
Expansion	1 x Mini PCIe
Speaker	2 x 1W
OS Support	Microsoft® Windows 10 (64-bit), Win 10 LTSC, Linux
Power Supply	9 - 32 Vdc
Power Consumption	i5-7300U 60W (Burn-in test 8.0 in Windows 10 64bit)
Operating Temperature	0 ~ 50 °C (32 ~ 122 °F) with SSD
Storage Temperature	-20 ~ 60 °C (-4 ~ 140 °F)
Relative Humidity	10 ~ 95% @ 40°C (non-condensing)
Shock	Operating 10 G Peak Acceleration (11 ms Duration), Follows IEC 60068-2-27
Vibration	Operating random vibration test, 5 ~ 500Hz, 2Grms with SSD, following IEC 60068-2-64
Safety and EMC	Safety: CB, UL, CCC, BSMI EMC: CE, FCC Class B, BSMI
Dimensions	317 x 246 x 60.5 mm (12.4 x 9.7 x 2.4 in)
Weight	3.4 kg (7.5 lb)

1.7 Ordering Information

Part Number	Description	Image
PPC-412	Intel Core i5-7300U Fanless PPC with 12.1" XGA LED backlight, resistive touch	
96PSA-A90W19OT-3	Power adapter 100 ~ 240 V _{DC} , 90 W, 19V with PFC	
PPC-WLAN-C1E	Wi-Fi module with antenna	
PPC-ARM-A03	Arm mount VESA standard	
PPC-174T-WL-MTE	Wall mount kit	

PPC-Stand-A1E

Stand kit



98R3P321110

TPM 2.0 module



Chapter 2

System Installation & Setup

Sections include:

- Quick Installation Guide
- Installation Procedures
- Installing Memory
- Installing HDD
- Installing M.2
- Installing Wireless LAN
- Installing Side COM Port/GPIO
- Installing TPM
- Installing Expansion Card
- AT/ATX Function Switch
- Grounding Installation
- Hook Installation
- Independent Quick Installation

2.1 Quick Start Guide

Before you start to set up the panel PC, take a moment to become familiar with the locations and purposes of the controls, drives, connectors, and ports, which are illustrated in the figures below.

When you place the panel PC upright on the desktop, its front panel appears as shown in Figure 2.1.



Figure 2.1 Front Panel

1. Power status indicator, off (S5): orange, on (S0): blue.

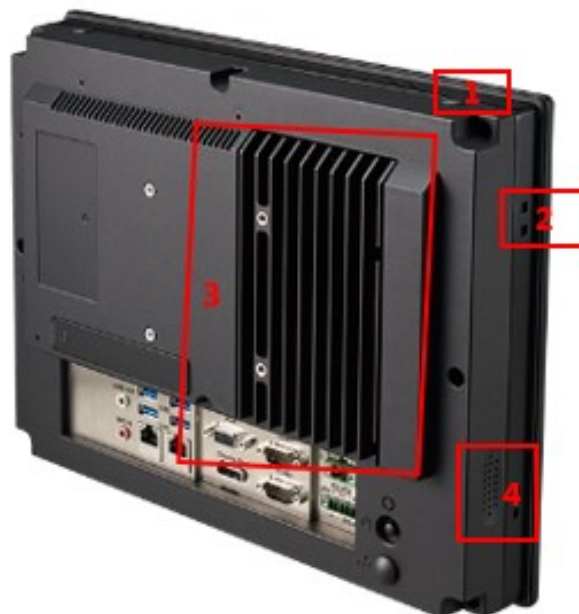

Figure 2.2 Side View

1. Antenna hole (two)
2. Panel mount bracket holes (eight)
3. CPU heatsink
4. Speaker (two)

I/O interfaces:

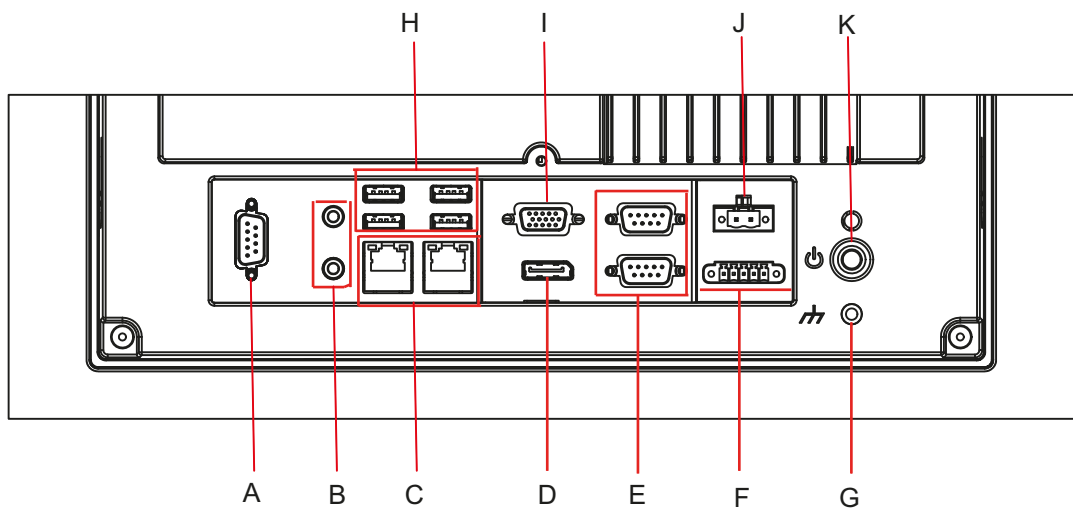

Figure 2.3 Location of I/O Interfaces

- A. 1x RS-232
- B. 1 x Mac-In/Line-Out
- C. 2 x Intel Gigabit Ethernet
- D. 1 x Display port
- E. 2 x RS-232
- F. 1 x Isolated RS-422/485
- G. SYS ground
- H. 4 x USB3.0
- I. 1 x VGA
- J. 1 x DC Input and AT/ATX switch
- K: 1 x Power button

2.2 Installation Procedures

2.2.1 Connecting the Power Cable

The panel PC has DC power socket (9-32 V). When connecting the power cable, please hold the plug end. Please follow the procedures below:

1. Connect the female end of the power cable to panel PC's DC socket.
2. Connect the male end of the power cable to power outlet.



Figure 2.4 Connecting the Power Cable

2.2.2 Connecting the Keyboard and Mouse

Connect the keyboard and mouse to panel PC's I/O interfaces.

2.2.3 Power ON

The power button is located in the right bottom side of the panel PC.

Note! Power cable and adapter are optional.



2.3 Install Memory Card

1. Loosen the screws as indicated in the red circle. (See Figure 2.5).
2. Press the red areas to pull out the hook (See Fig 2.6 ~ 2.7) and open the rear cover.



Figure 2.5



Figure 2.6



Figure 2.7

3. Remove the yellow warning tag first. Then remove the screws as indicated in the red circle. (See Figure 2.8), and take out the strength plate & CPU heat sink.

Note! Take out the black and blue thermal grease from the accessory box (as indicated in Figure 2.9). Attach the CPU heat sink and strength plate after the grease is applied.

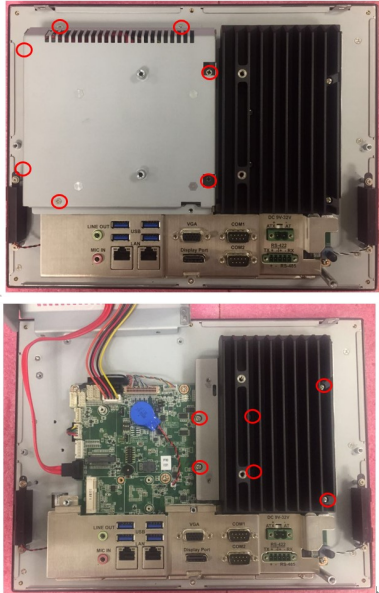

Figure 2.8

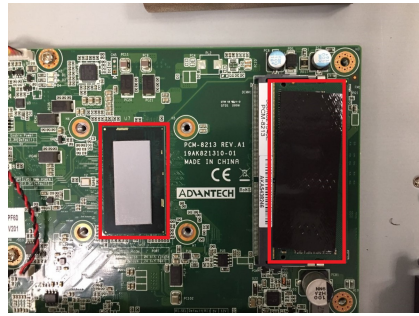

Figure 2.9

Note! CPU cooler pad surface is isolated by anodization treatment to avoid static electricity (CPU contact side excluded).



2.4 Installing the SSD

1. Follow the procedures in Section 2.3 to open the rear cover and remove the screws as indicated in the red circles in Figure 2.10.

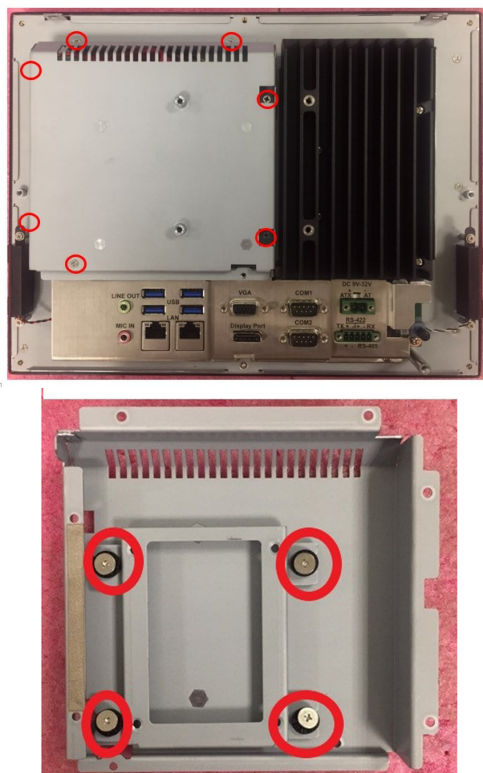

Figure 2.10

2. Install the SSD (see Figure 2.11), and take out the 4 screws from the accessory box to attach the SSD and then attach the strength-plate.



Figure 2.11

3. Lock the HDD bracket, and connect the HDD cable to the mainboard (see Figure 2.12).



Figure 2.12

2.5 Installing M.2

1. Follow the procedures in Section 2.3 to remove the rear cover and strength-plate (See Figure 2.13).
2. Plug the M.2 into the mainboard interface, and remove the 2 M2.5x4 screws from the accessory box to attach (see Figure 2.14).
3. Return the rear cover and strength-plate.

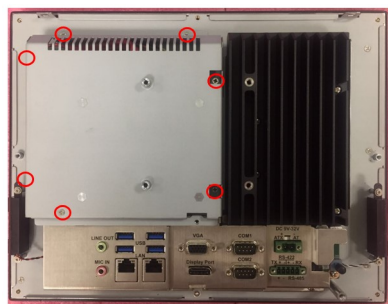

Figure 2.13

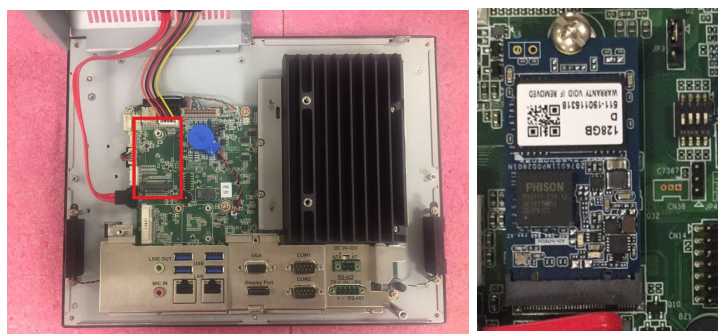

Figure 2.14

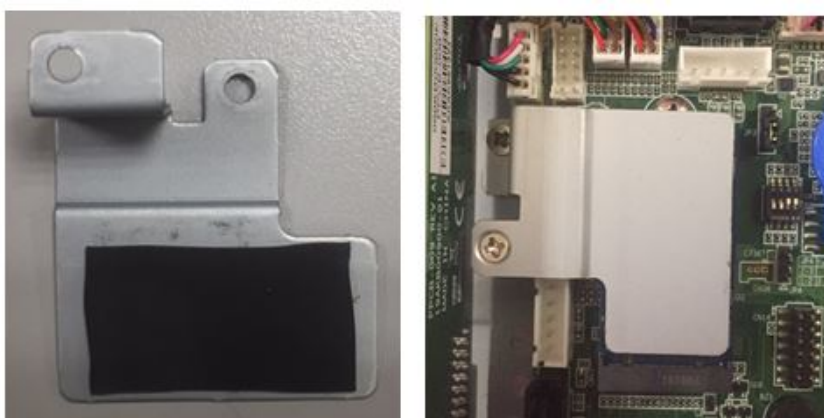

Figure 2.15

2.6 Installing Wireless LAN Card

1. Follow the procedures in Section 2.3 to open the rear cover and strength-plate. The wireless LAN card can be installed to the locations as indicated in Figure 2.16. For the wireless short card, you need to take out one hexagonal screw from the accessory box to attach it with (Note: If a half-size PCIE card is used, then the screw circled in red should be tightened up too, See Figure 2.17).

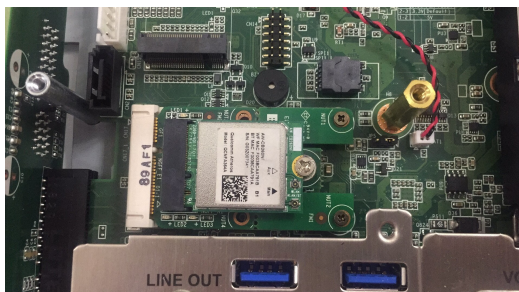

Figure 2.16

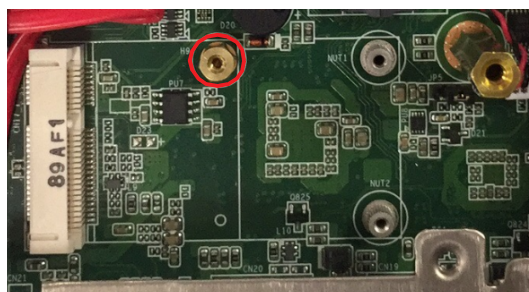

Figure 2.17

2. Connect the wireless LAN card module cable to the antenna bracket, please note the installation direction of cable end and screws/cushions (see Figure 2.18).
3. Remove the two plugs on the left and right sides of the rear cover (see Figure 2.19).
4. Return the rear cover and install the antenna of the wireless LAN card module (see Figure 2.20).

Note! For wireless LAN card module, choose Advantech Product: (Part No. PPC-WLAN-C1E).



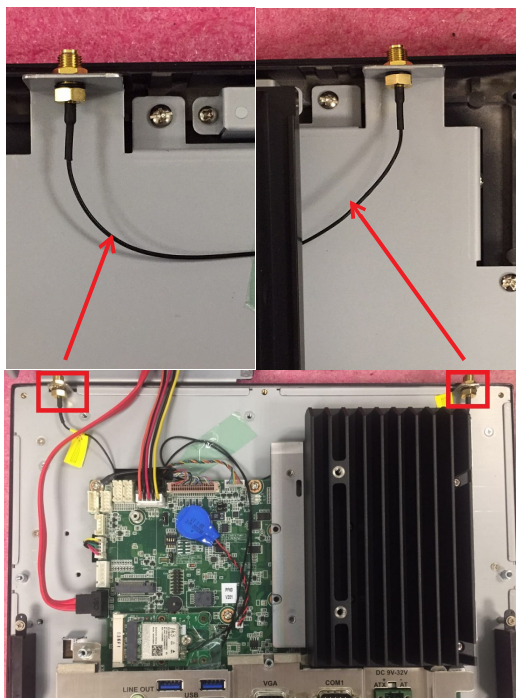

Figure 2.18

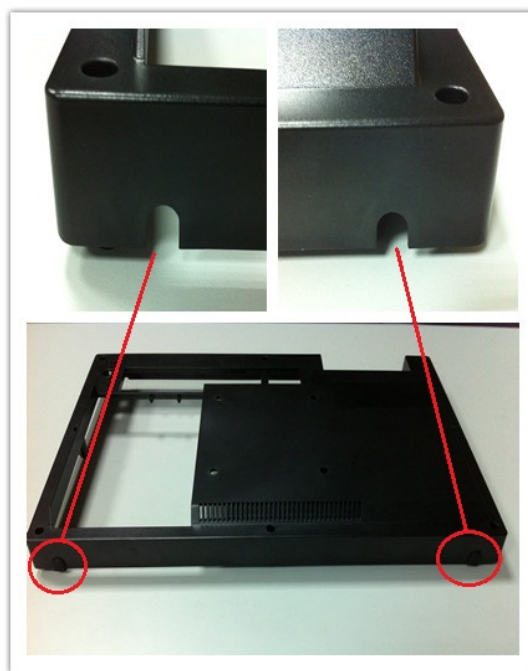

Figure 2.19



Figure 2.20

2.7 Installing TPM (current mechanism only supports 98R3P321110)

1. Refer to Section 2.3 to remove the back cover and the reinforcement plate. Remove the TPM card from the TPM module and fix it on the back of the reinforcement plate. See Figure below.

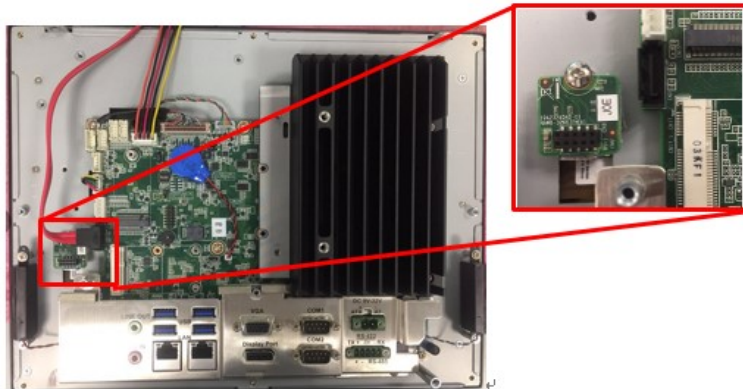

Figure 2.21

2. Align the white point of the TPM Cable Pin 1 and the Pin of the motherboard CN14, then insert the screws on the reinforcing plate.

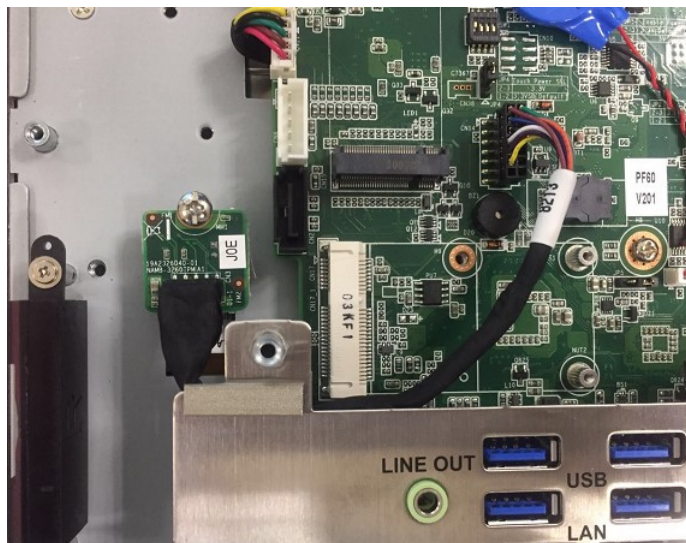

Figure 2.22

2.8 AT/ATX Function Switch

The switch is built in to the machine. Use it to choose AT/ATX functions without removing the rear cover.



Figure 2.23 ATX Mode

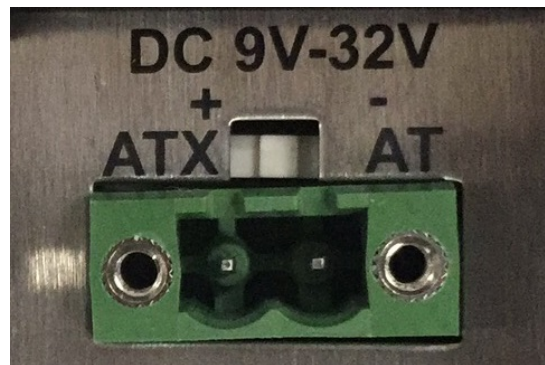

Figure 2.24 AT Mode

2.9 Grounding Installation

2.9.1 System Grounding Installation



Figure 2.25



Figure 2.26



Figure 2.27



Figure 2.28

Note! The grounding cable is not provided in the accessory box.



2.9.2 Cabinet Installation and Grounding

Follow these instructions to install the PPC system, and pay attention to the ground pin which should be connected to the earth/ground. PPC system should give the best performance for optimum EMI immunity, ESD immunity, surge immunity, and system isolation. If the PPC system is embedded in the cabinet, the PPC system's ground, cabinet's ground and earth/ground should be connected together.

1. Install the PPC system into the cabinet.

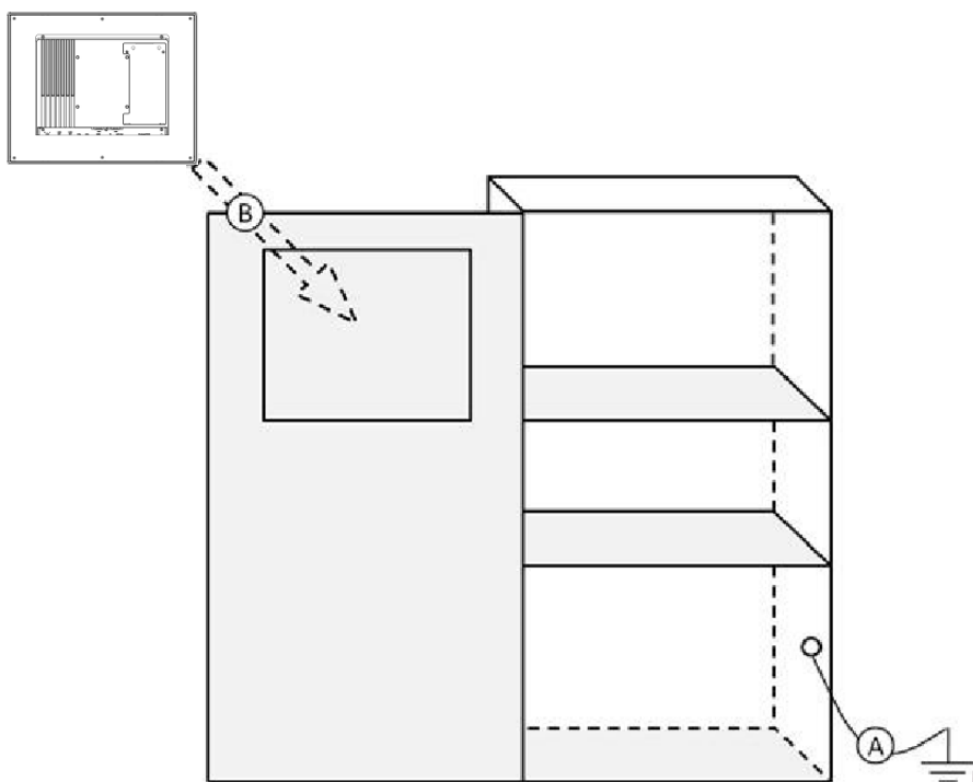

Figure 2.29 Cabinet Installation

- a. Connect the cabinet to the earth/ground.
- b. Embed null PPC system into the cabinet without any I/O cable and power.

2. System wiring.

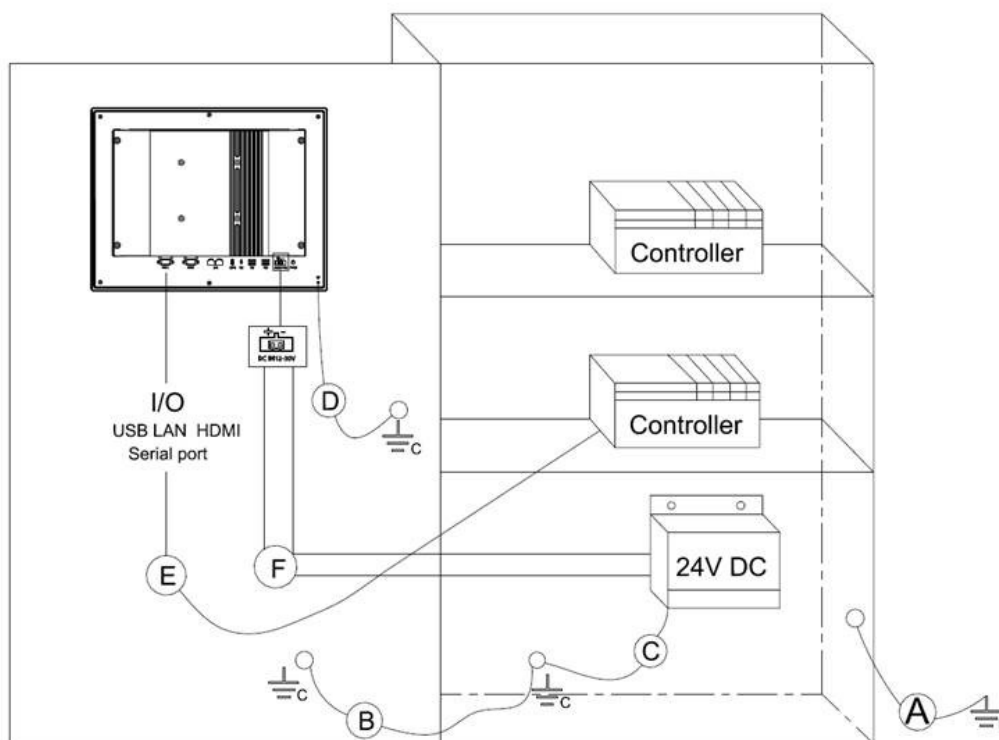

Figure 2.30 System Wiring Diagram

- a. Connect the cabinet to the earth/ground.
- b. Ensure that all cabinets have been grounded together.
- c. Connect the ground of the power supply to the cabinet.
- d. Connect the ground pin of PPC system to the cabinet.

Note! *The wire of the protective earthing conductor should be green-and-yellow, xx AWG/ 0.75mm² and connected to the earth on the building.*



Ensure that the voltage of the power source is correct before connecting the equipment to a power outlet through a power cord connected to a socket-outlet with an earthed connection.

2.10 Hook Installation

Follow the Figures below:

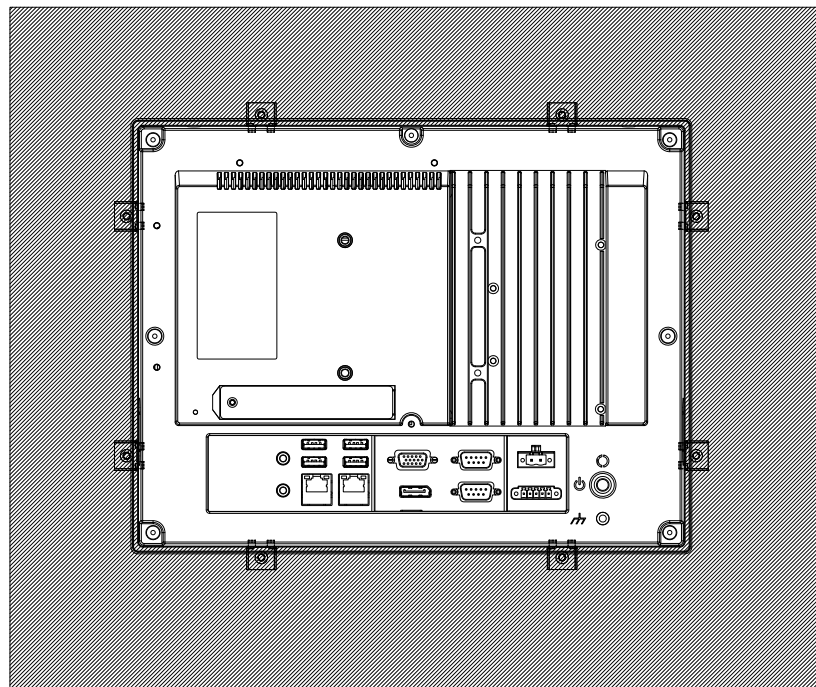
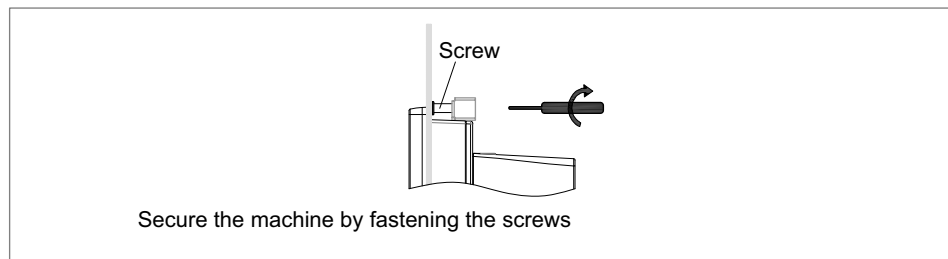
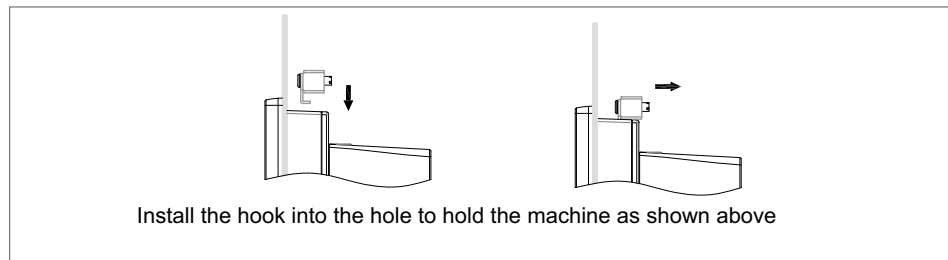
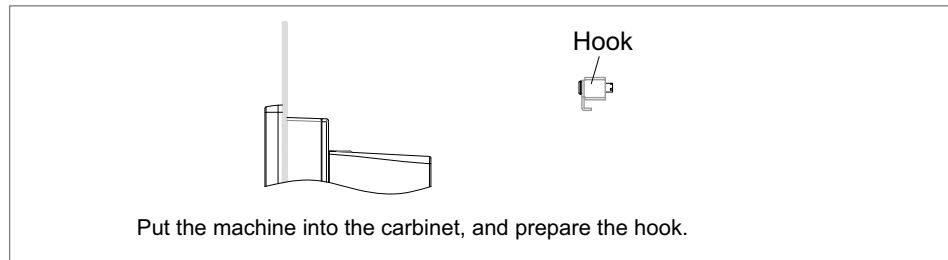

Figure 2.31 Hook Installation

Chapter 3

Jumper Configuration

Sections include:

- Jumper & Connectors
- External COM Port Pin Definition

3.1 Jumper & Connector

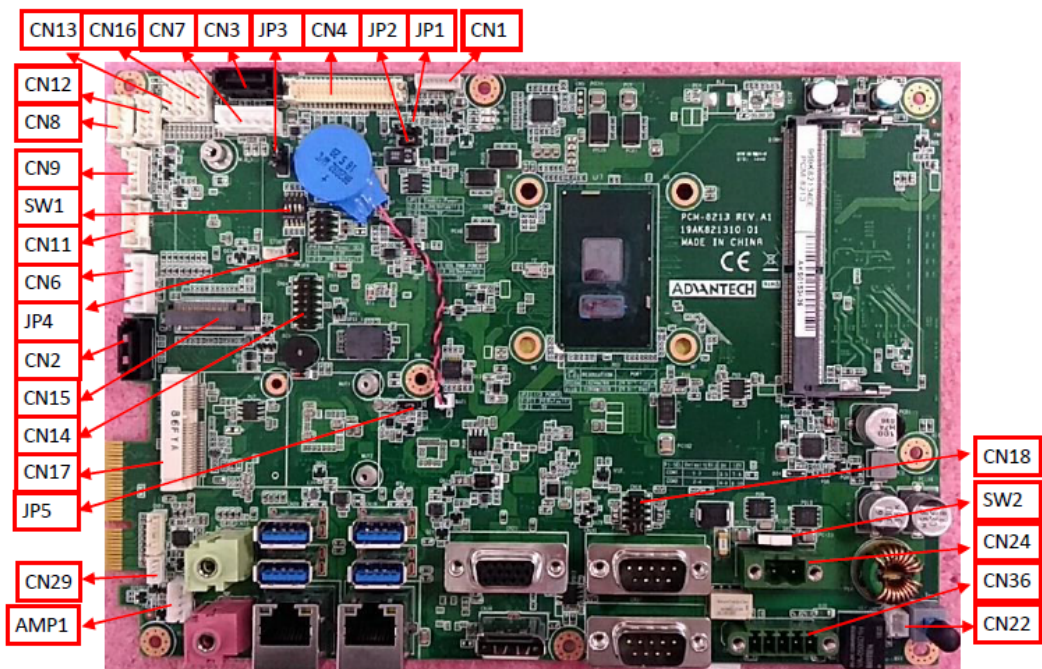
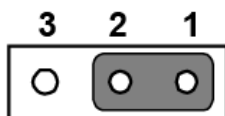

Figure 3.1 PCM-8213 Front View

Connectors	Functions
CN1	Inverter
CN2/CN3	SATA1/ SATA2
CN4	LVDS
CN6/CN7	SATA POWER
CN8/CN9	Internal USB
CN11	Resistance Touch
CN12	GPIO
CN16/CN13	COM4/COM5
CN14	LPC CONN
CN15	M.2 Conn
CN17	Mini PCIe Conn
CN18	COM Pin9 Power Select (COM1&COM2)
CN22	Power Button
CN24	Power Input
CN29	Front LED
CN36	COM3 (RS422/485)
AMP1	Amplifier Conn
JP1/JP2	Invert Enable/PWM Power Select
JP3	Panel Power Select
JP4	Touch Power Select
JP5	RTC Reset
SW1	Panel Resolution
SW2	AT/ATX Select

JP1	Picture	Invert Enable Power Select
(1-2)	P1	5V
(2-3)	P2	3.3V Default*



P1

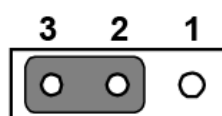

P2

JP2	Picture	Invert PWM Power Select
(1-2)	P3	5V
(2-3)	P4	3.3V Default*

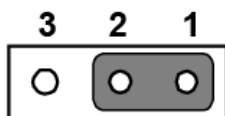

P3

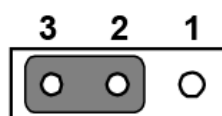

P4

JP3	Picture	Panel Power Select
(1-2)	P5	5V
(2-3)	P6	3.3V Default*

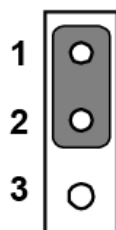

P5

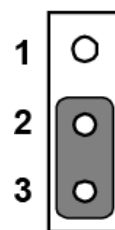

P6

JP4	Picture	Resistance Touch Power Select	
(1-2)	P7	3.3VSB	Default*
(2-3)	P8	3.3V	

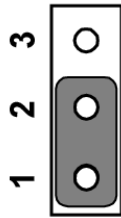

P7

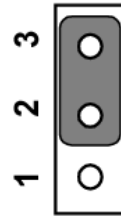

P8

JP5	Picture	RTC Reset	
(1-2)	P9	Normal*	Default*
(2-3)	P10	CMOS Clear	

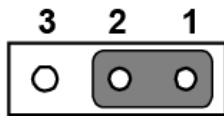

P9

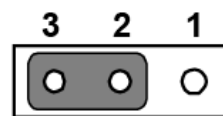

P10

CN18	Picture	COM1/2 RING and Power Select	
(1-3)/(2-4)	P11/P12	COM1/COM2 RI	Default*
(3-5)/(4-6)	P13/P14	COM1/COM2 5V	
(7-9)/(8-10)	P15/P16	COM1/COM2 12V	

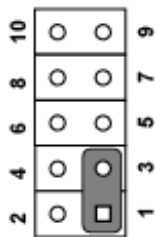

P11

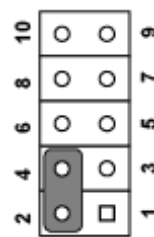

P12

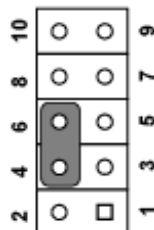
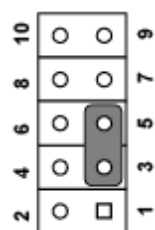

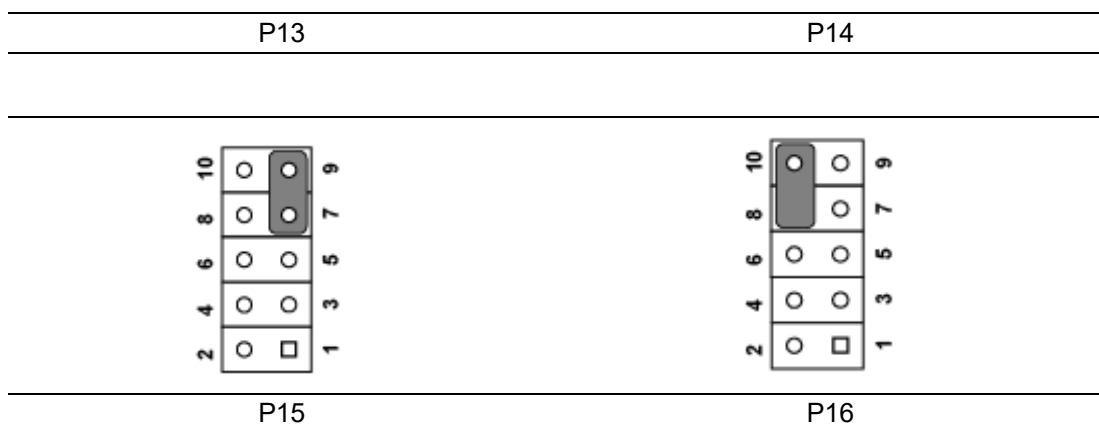

SW1	AT/ATX Select		
0001	P17	1024*768	PPC-412

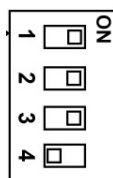

P17

SW2	AT/ATX Select		
1-3	P19	ATX Power	Default*
2-3	P20	AT Power	

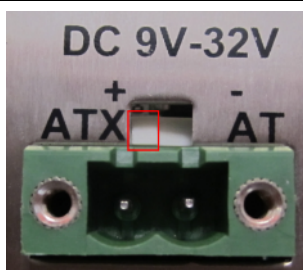

P19

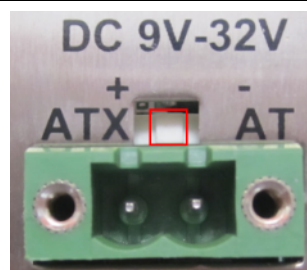

P20

CN12 GPIO

Pin	Name
1	GND
2	GPIO4
3	GPIO0
4	GPIO5
5	GPIO1
6	GPIO6
7	GPIO2
8	GPIO7
9	GPIO3

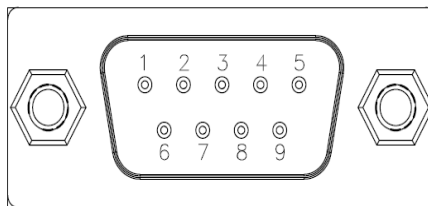

3.2 External COM Port Pin Definition

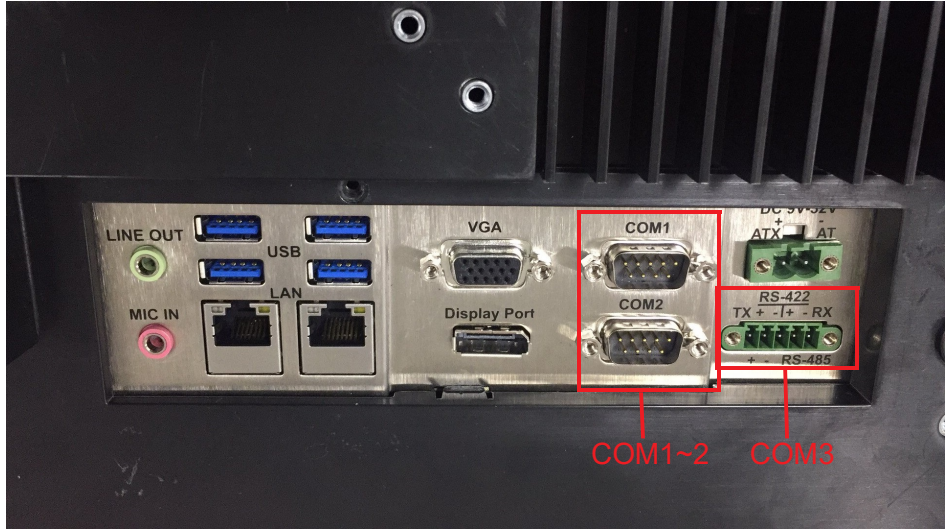

Figure 3.2 COM Ports

COM 1 and COM 2 (RS232, pin 9 supports 5 V/12 V output)

COM 3 RS-422/485

COM 1-2:

PIN	COM1/COM2
1	DCD
2	RXD
3	TXD
4	DTR
5	GND
6	DSR
7	RTS
8	CTS
9	RING or 5V/12V output

Pin 9 is set as RI signal in COM port by default, and could be set as 5V/12V output by Jumper.

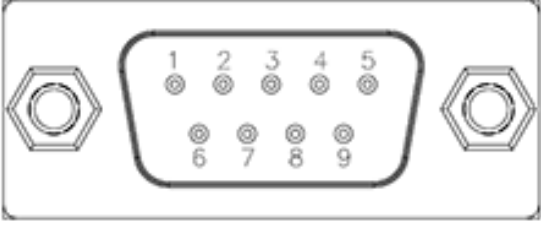

COM3: RS422/485 with Isolation 1000 VDC, BIOS selectable.

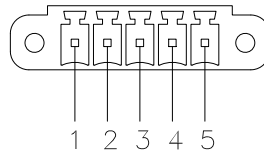

Pin	1	2	3	4	5
RS422	TX+	TX-	RX+	RX-	GND
RS485	D+	D-			GND

UART RS485 Auto Flow Control

COM5 supports RS485 auto flow control function for all UART.

When enabling the RS485 auto control function, it will automatically drive RTS# pin to logic high or low for flow control.

To make this RS485 auto flow control function work, please note that the parity and stop-bit setting has to be one of the following three settings:

- (1) 8 data bits + 1 parity bit + 1 stop bit
- (2) 8 data bits + 1 parity bit + 2 stop bits
- (3) 8 data bits + 2 stop bits

Chapter 4

Software Configuration

Sections include:

- Installing Drivers
- BIOS Setup Program

4.1 Install Drivers

Before installing software on the panel PC, install the corresponding drivers to ensure full functionality.

All drivers can be downloaded from the Advantech website:

<http://www.advantech.com>

4.2 BIOS Setup Program

4.2.1 Entering BIOS Setup

When the power is turned on, press the button to enter BIOS setup screen.

Whenever a change is made, press <F4> to save and exit; otherwise the settings will not be saved in the BIOS.

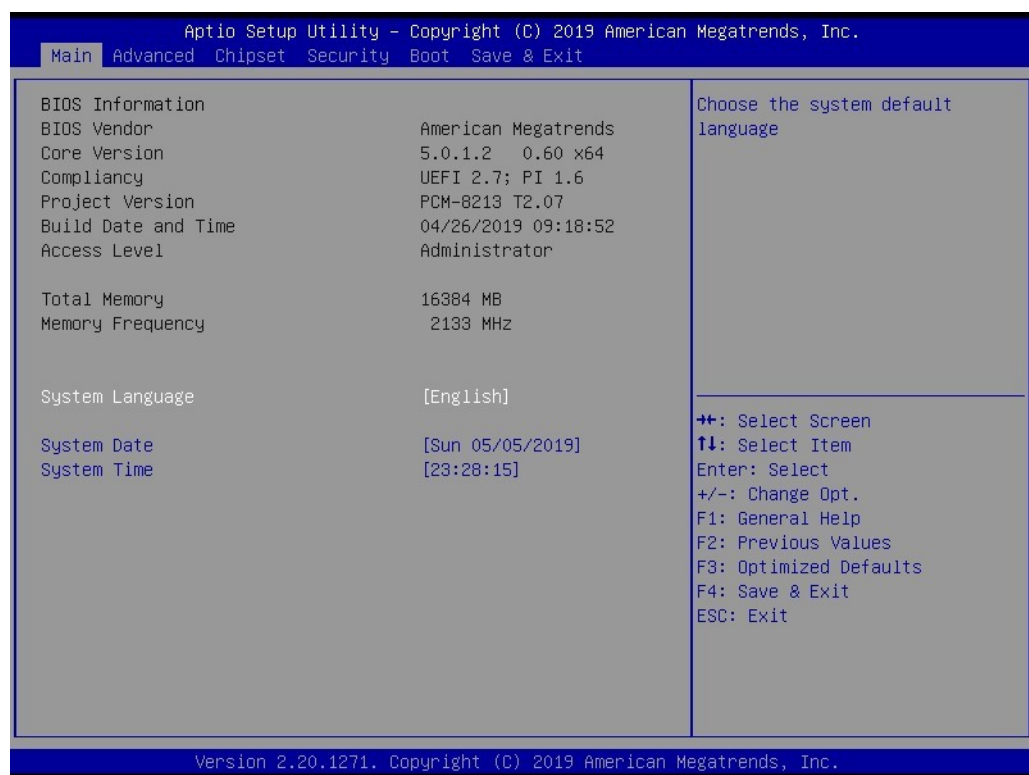

4.2.2 Adjustment of LCD Brightness

1. Select "System Agent (SA) Configuration" in "Chipset" tab.

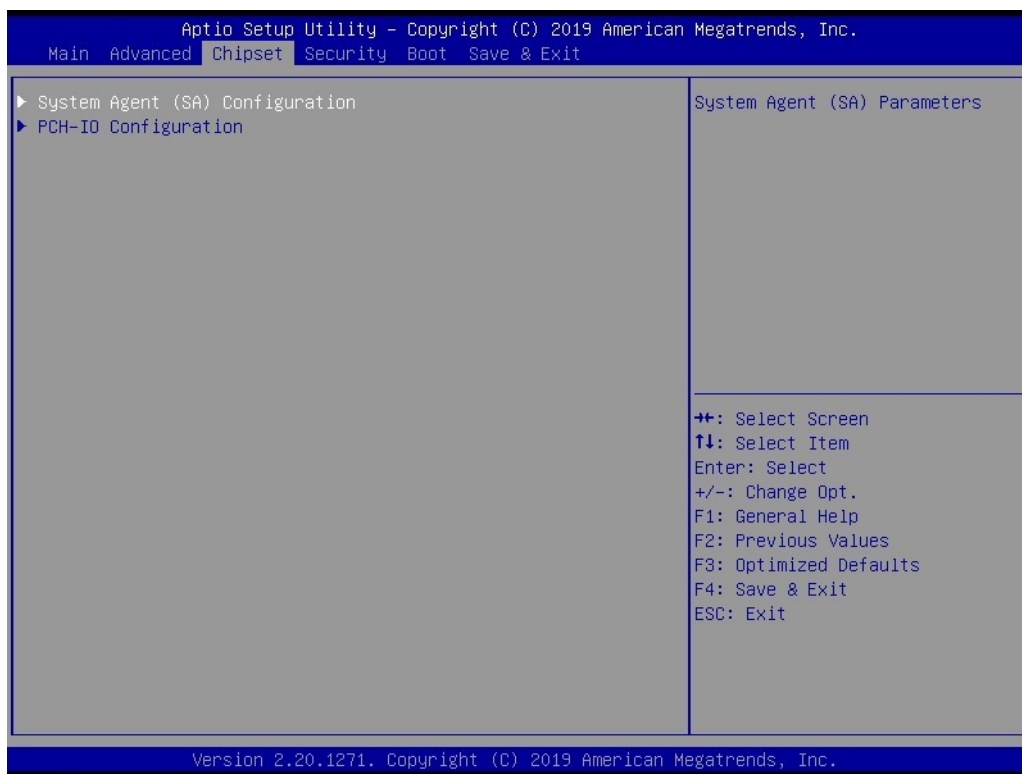

2. Then select "Graphics Configuration".

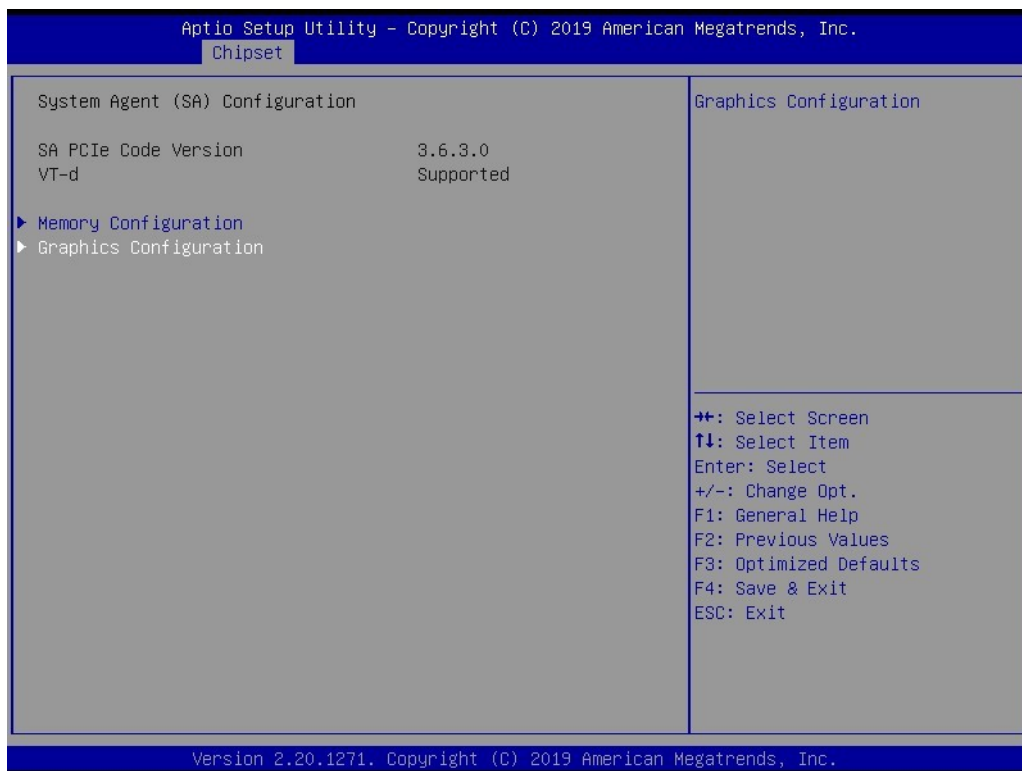

3. Select "LCD Control".

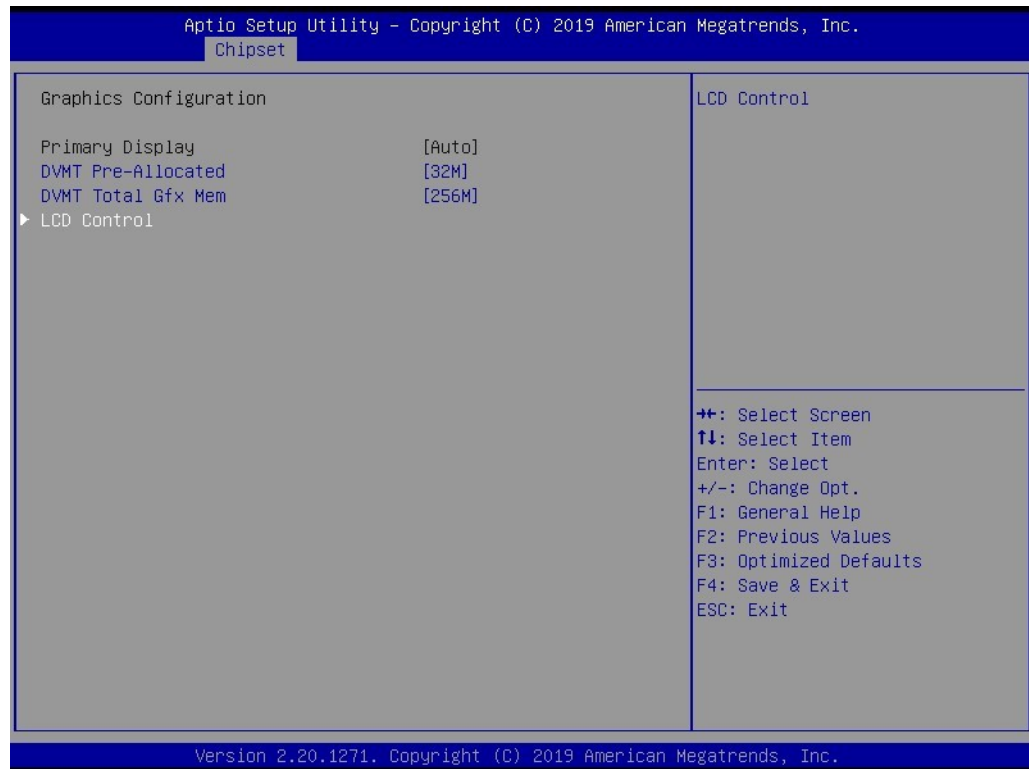

4. There will be six brightness levels to choose in "Brightness Manual Control".

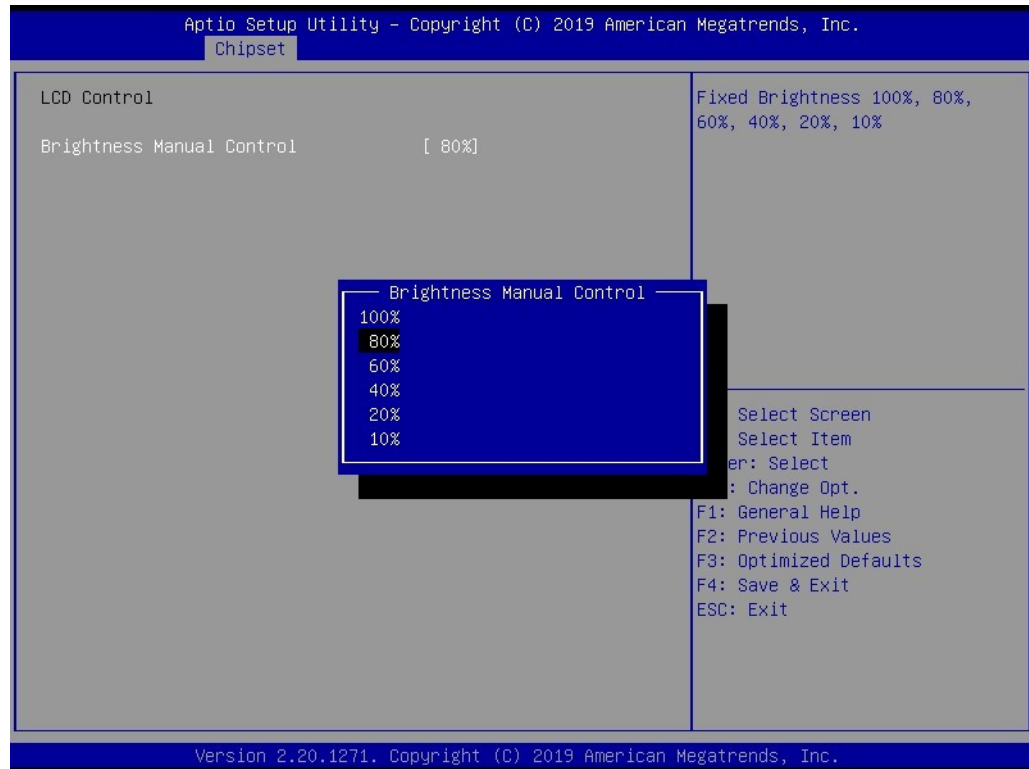

4.2.3 COM3 Mode Selection (RS422/RS485)

1. Select “NCT6106D Super IO Configuration” in the “Advanced” tab.

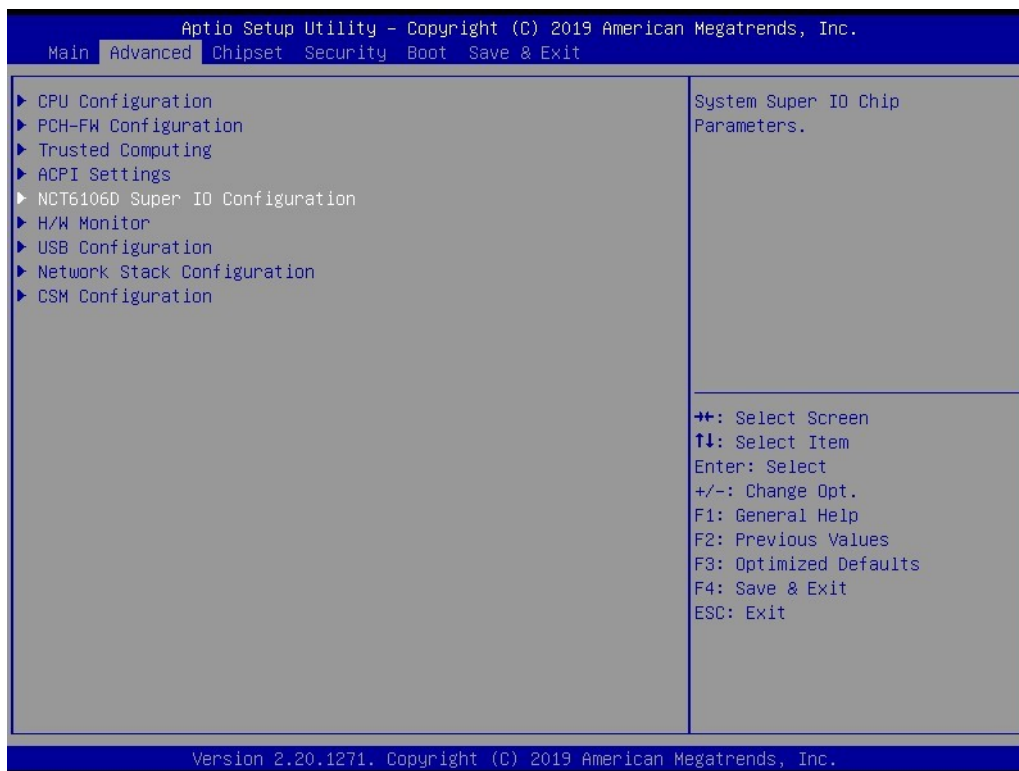

2. Select “Serial Port 3 Configuration” and click to select.

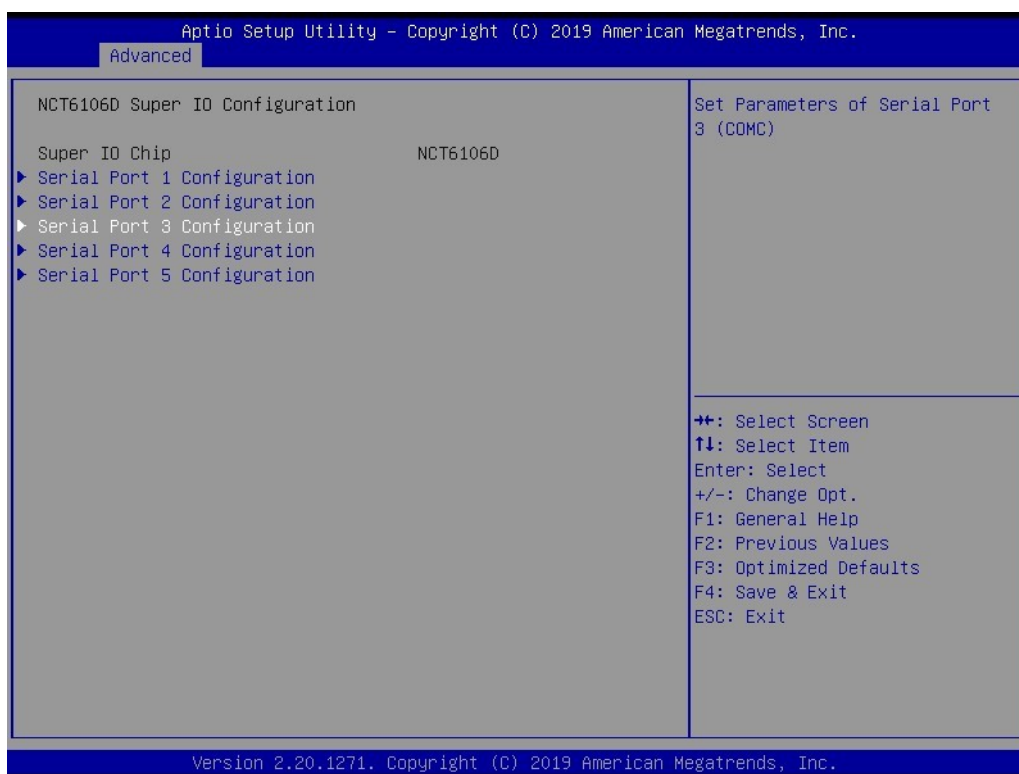

3. Select "Serial Port 3 Mode" and then click to select COM3 operation mode [RS422] or [RS485].

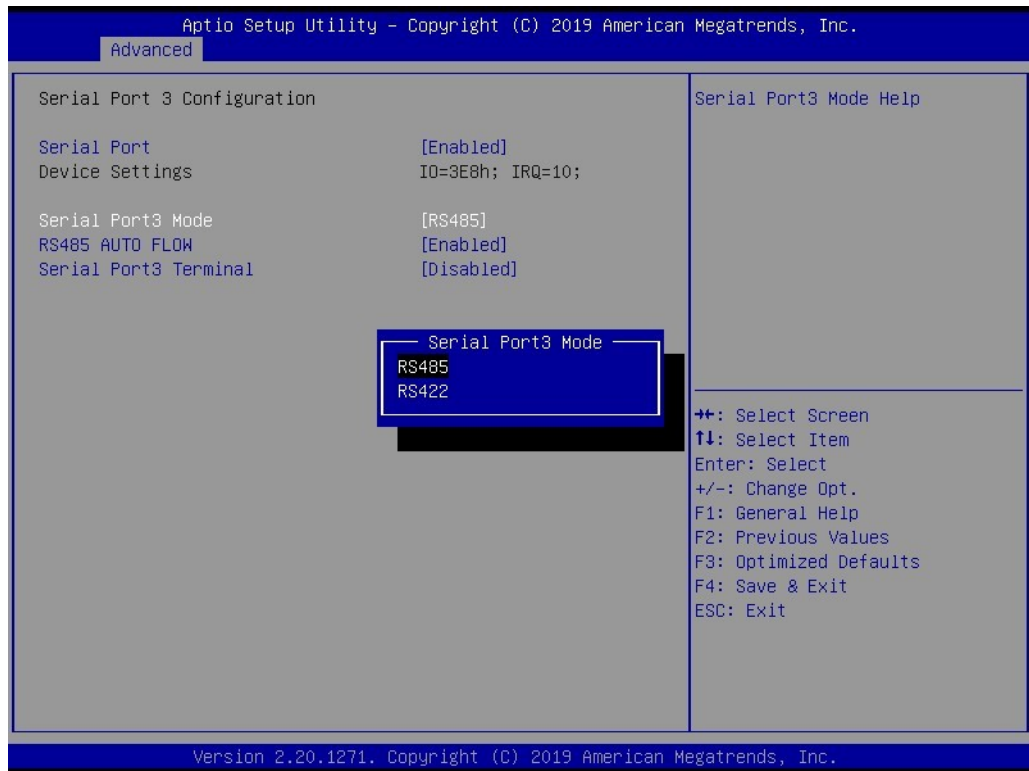

4. When COM3 Mode is selecting RS485, "RS485 Auto Flow" also can select [Enabled] or [Disabled].

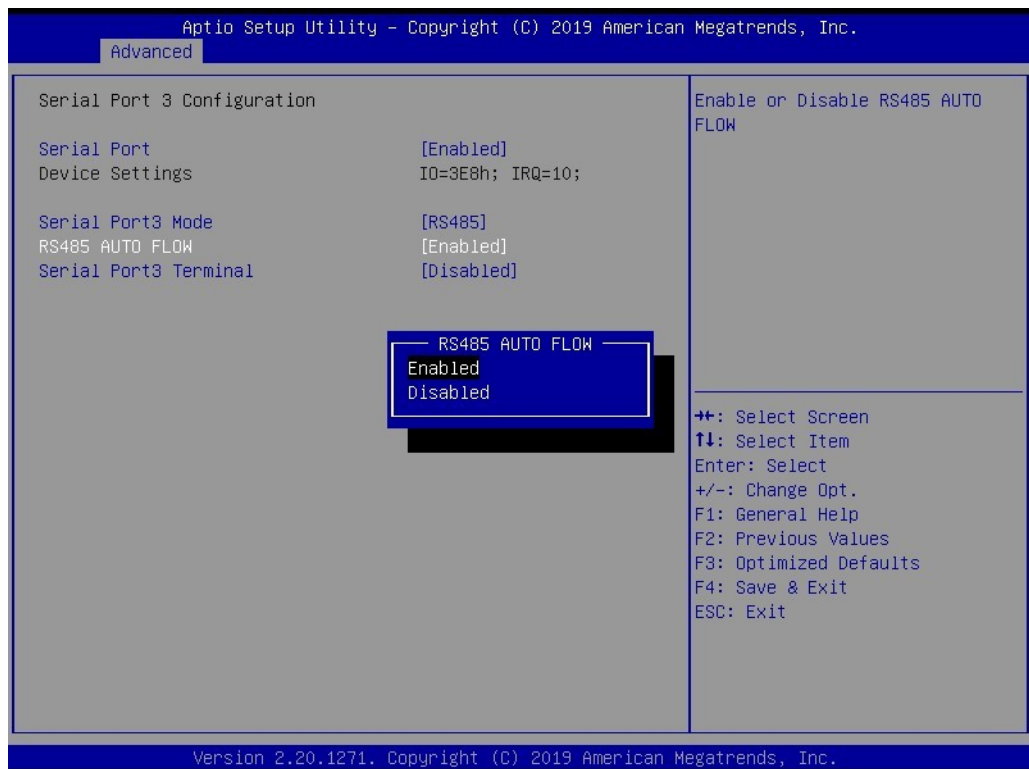

When COM3 Mode is RS422/RS485, “Serial Port3 Terminal” can also select [Enabled] or [Disabled].

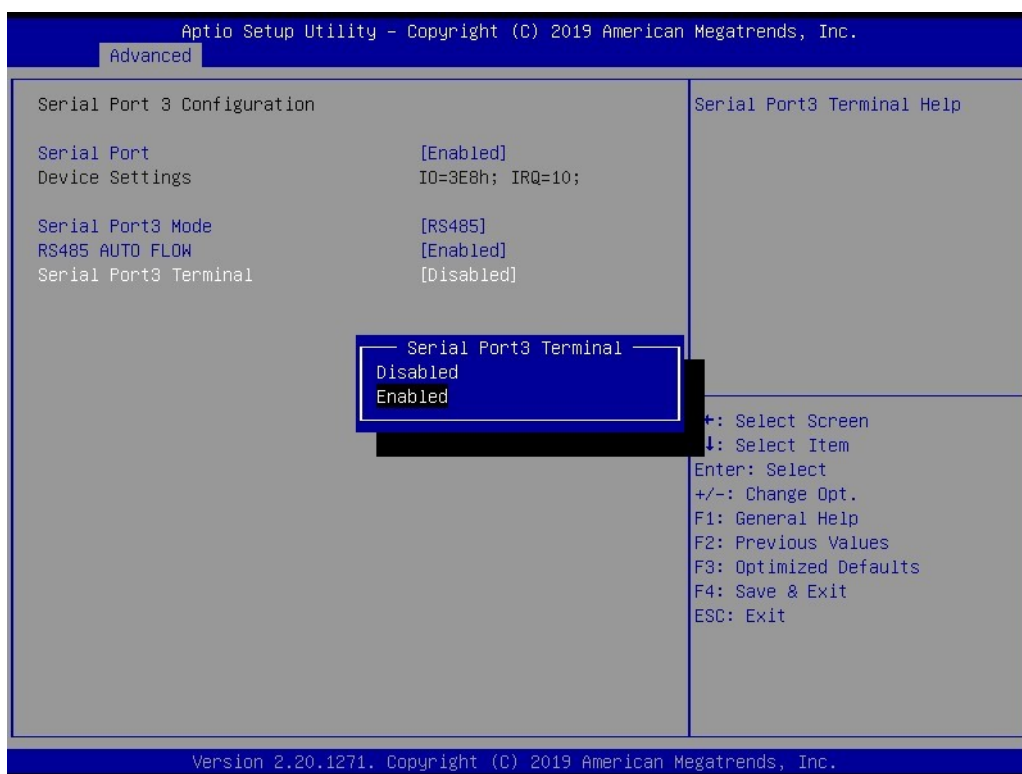

4.2.4 BIOS AT & ATX Setup

1. Select “PCH-IO Configuration” in the “Chipset” tab.

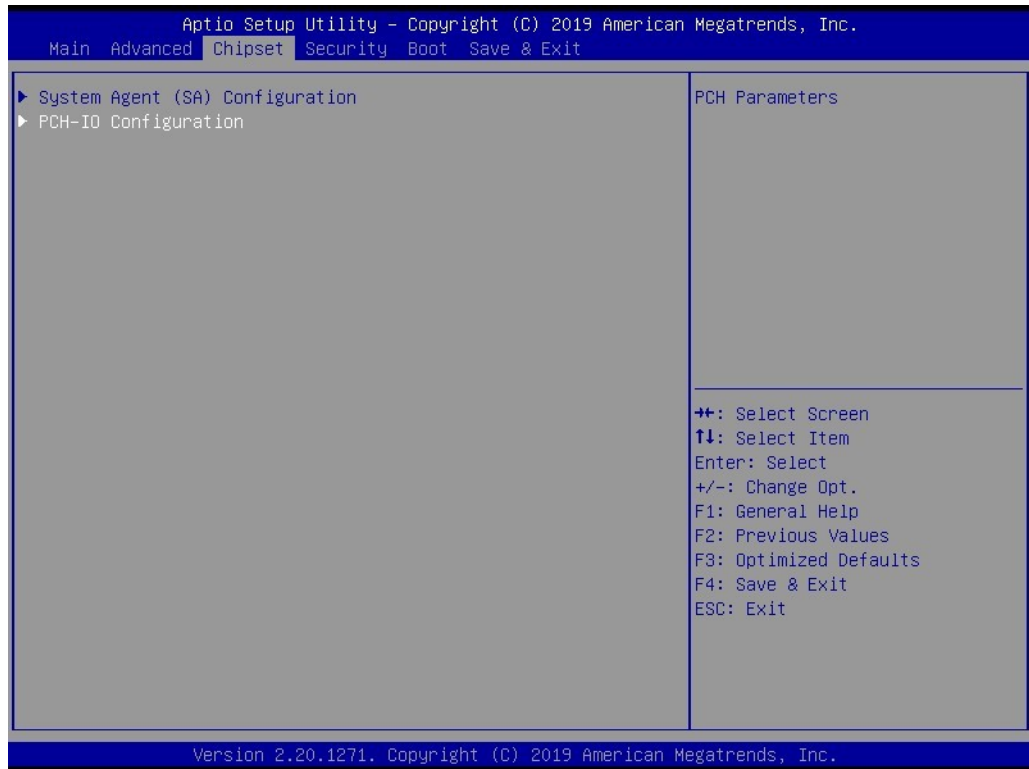

2. In “Restore AC Power Loss”, set “Power On” for “AT mode” and “Power Off” for “ATX mode”.

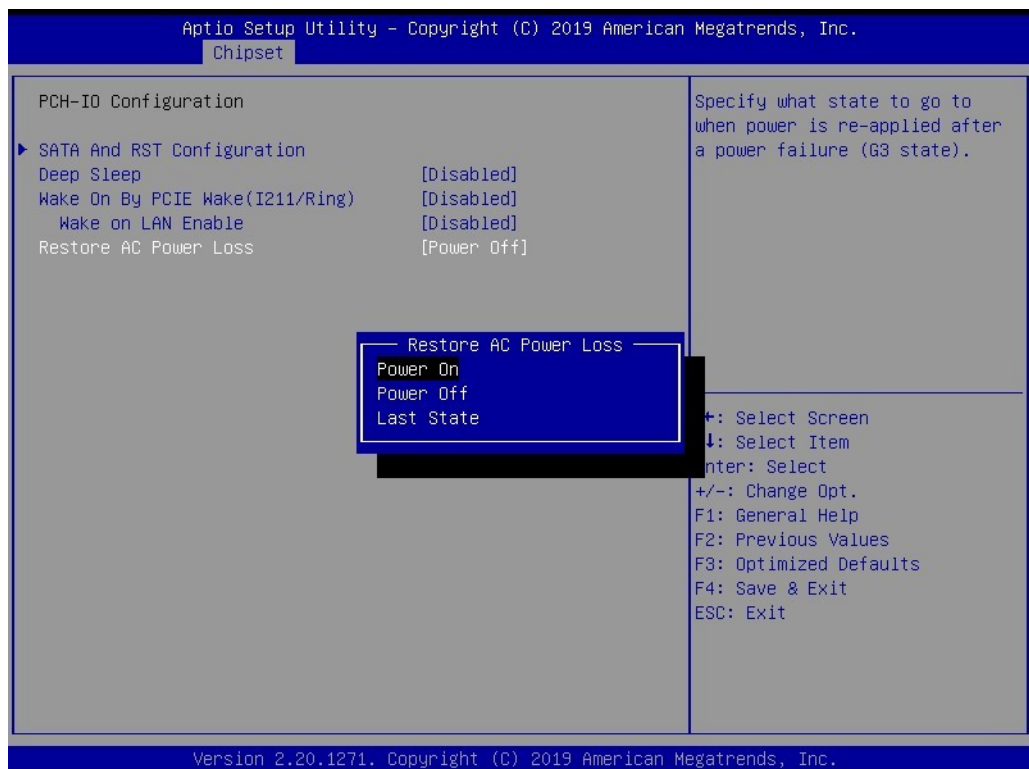

4.2.5 Wake on LAN or Ring

1. Select “PCH-IO Configuration” in the “Chipset” tab.



2. Set “Wake on By PCIE Wake” to “Enabled” if wake up is through I211 or Ring.

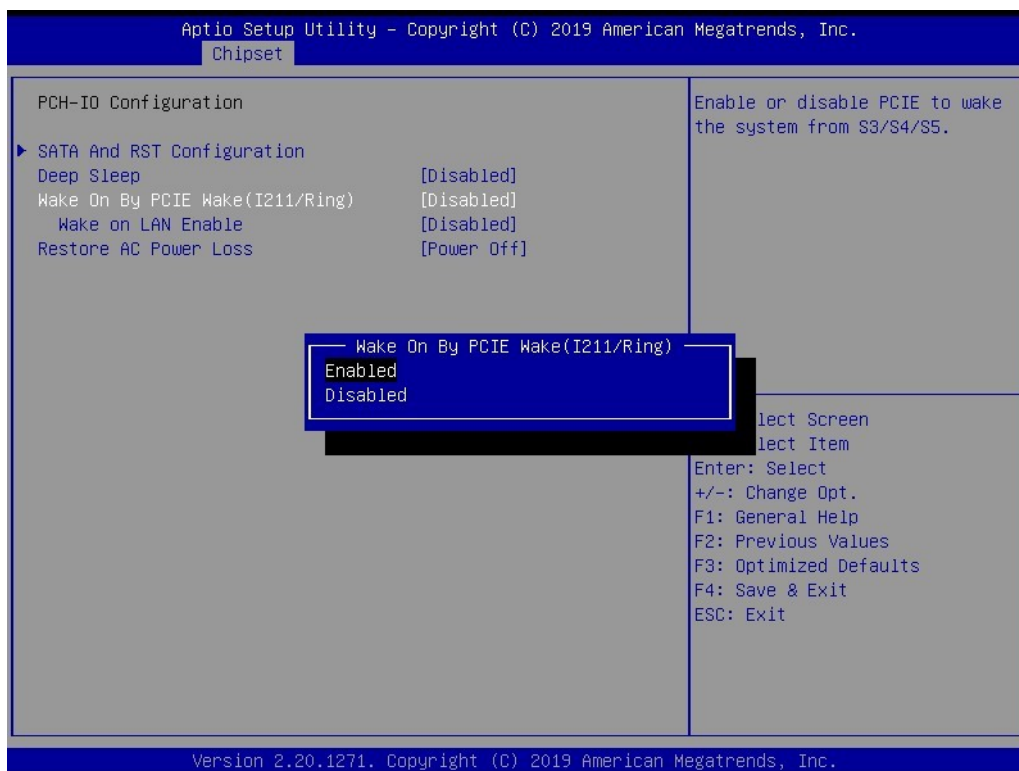

- Set "Wake on LAN Enable" to "Enabled" if wake up is through I219.

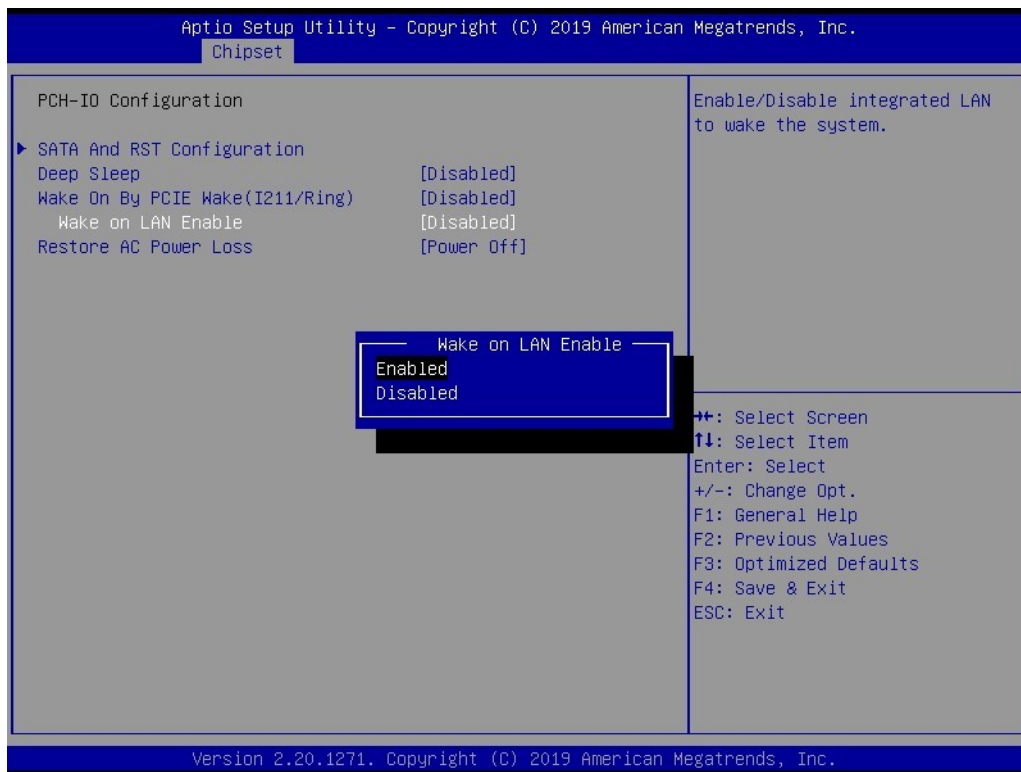

4.2.6 TPM Settings

- Press the Del key to enter the BIOS and select "Trusted Computing" under Advanced.

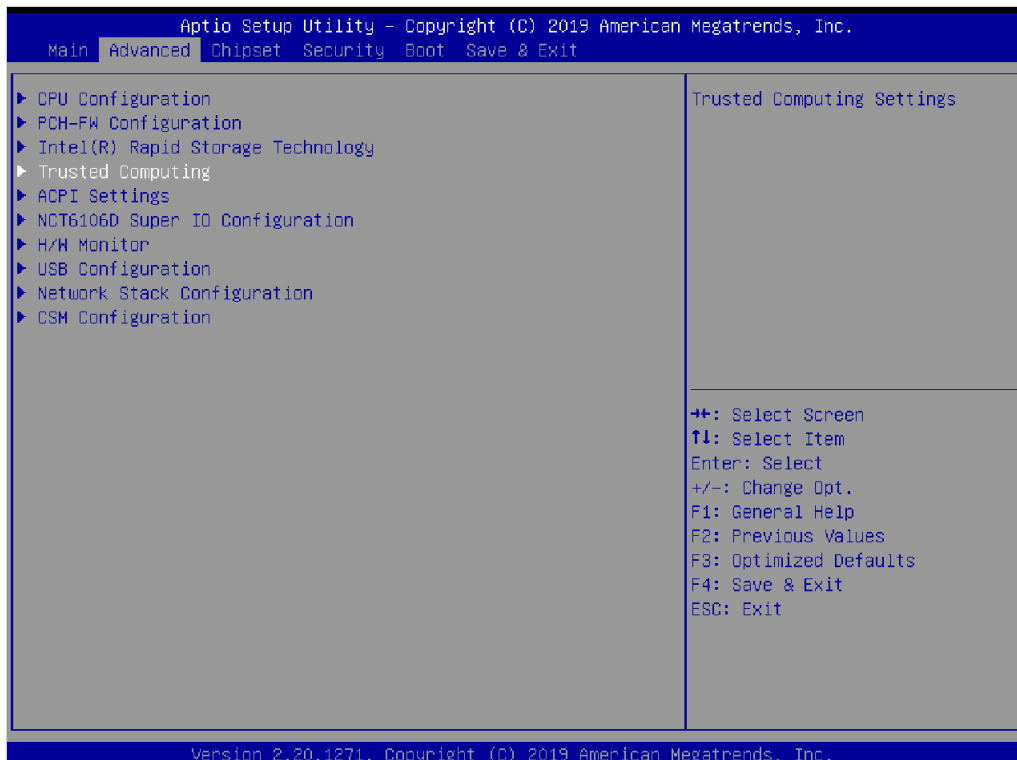

- Change the Security Device Support setting to “Enable”, save and exit and restart.

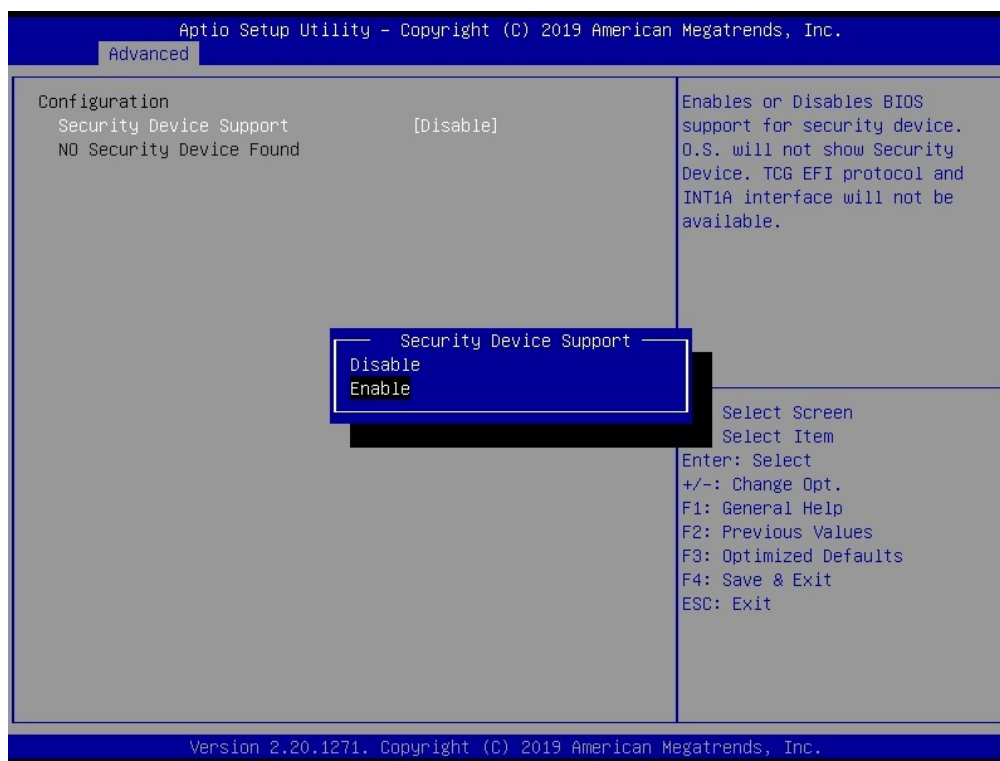

- Entering the BIOS again will show that the device is found and can operate normally.

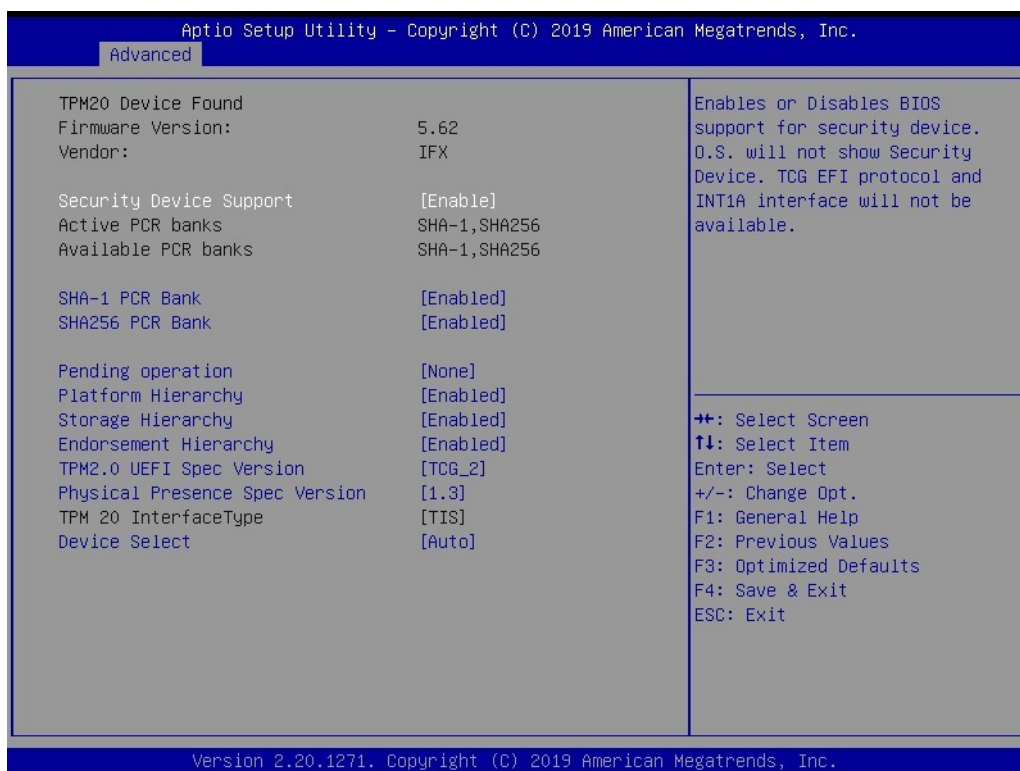

www.advantech.com

Please verify specifications before quoting. This guide is intended for reference purposes only.

All product specifications are subject to change without notice.

No part of this publication may be reproduced in any form or by any means, electronic, photocopying, recording or otherwise, without prior written permission of the publisher.

All brand and product names are trademarks or registered trademarks of their respective companies.

© Advantech Co., Ltd. 2022