

chcoze

DV-1100

User Manual



Rugged Embedded Computer

13/12th Gen. Intel® Core™ Series High Performance and Basic Function
Rugged Embedded Computer

Contents

Preface	5
Revision	5
Copyright Notice	5
Acknowledgement	5
Disclaimer.....	5
Declaration of Conformity	5
Product Warranty Statement	6
Technical Support and Assistance.....	7
Conventions Used in this Manual	8
Safety Precautions	8
Package Contents.....	9
Ordering Information.....	10
Chapter 1 Product Introductions	11
1.1 Overview	12
1.2 Hardware Specification	14
1.3 External Layout	18
1.3.1 Front	18
1.3.2 Rear.....	18
1.4 Dimensions.....	19
Chapter 2 Switches & Connectors	20
2.1 Location of Switches and Connectors.....	21
2.2 Switches and Connectors Definition	22
2.3 Switches Definition	23
2.4 Definition of Connectors.....	26
2.5 Optional Module: Definition of Switches and Connectors	32
2.5.1 CMI-COM06 Module	32
2.5.2 CMI-DIO06 Module.....	34
Chapter 3 System Setup.....	35
3.1 Removing Top Cover	36
3.2 Installing Antenna	38
3.3 Installing CPU	40
3.4 Installing SO-DIMM	43
3.5 Installing Top Cover.....	44
3.6 Installing 2.5" SATA HDD/SSD	45
3.7 Installing M.2 Key M Module	46
3.8 Installing M.2 Key B Module	47
3.8.1 M.2 Key B type 3052.....	47
3.8.2 M.2 Key B type 3042.....	48
3.8.3 M.2 Key B type 2242.....	49

3.9 Installing M.2 Key E Module	50
3.10 Installing CMI Module	51
3.10.1 CMI-DP01-R10/UB1606-R10 Module	51
3.10.2 CMI-HD03-R10/UB1608-R10 Module	53
3.10.3 CMI-COM06-R10/UB1603-R10	54
3.10.4 CMI-DIO06-R10/UB1618-R20	56
3.11 Installing CFM Module	57
3.11.1 CFM-IGN04-R10	57
3.12 Installing Bottom Cover	58
3.13 Removing Maintenance Area Panel	58
3.14 Installing SIM Card	59
3.15 Replacing CMOS Battery	60
3.16 Installing Maintenance Area Panel	63
3.17 Installing Wall Mount	63
3.18 Installing VESA Mount	64
3.19 Installing DIN-Rail Mount	65
3.20 Installing External FAN	66
Chapter 4 BIOS Setup	68
4.1 BIOS Introduction	69
4.2 Main Setup	70
4.3 Advanced Setup	70
4.3.1 CPU Configuration	71
4.3.2 Power & Performance	72
4.3.3 SATA Configuration	73
4.3.4 PCH-FW Configuration	74
4.3.5 Trusted Computing Settings	75
4.3.6 ACPI Settings	76
4.3.7 F81966 Super IO Configuration	76
4.3.8 Hardware Monitor	78
4.3.9 S5 RTC Wake Settings	79
4.3.10 Serial Port Console Redirection	79
4.3.11 USB Configuration	80
4.3.12 Network Stack Configuration	80
4.3.13 CSM Configuration	81
4.3.14 NVMe Configuration	81
4.4 Chipset Setup	82
4.4.1 System Agent (SA) Configuration	82
4.4.2 PCH-IO Configuration	84
4.5 Security Setup	87
4.6 Boot Setup	88
4.7 Save & Exit	89

Chapter 5 Product Application.....	90
5.1 Where to download drivers?	91
5.2 Where to find the technical documents?	91

Preface

Revision

Revision	Description	Date
1.00	New Release	2024/05/31

Copyright Notice

© 2024 by Cincoze Co., Ltd. All rights are reserved. No parts of this manual may be copied, modified, or reproduced in any form or by any means for commercial use without the prior written permission of Cincoze Co., Ltd. All information and specification provided in this manual are for reference only and remain subject to change without prior notice.

Acknowledgement

Cincoze is a registered trademark of Cincoze Co., Ltd. All registered trademarks and product names mentioned herein are used for identification purposes only and may be trademarks and/or registered trademarks of their respective owners.

Disclaimer

This manual is intended to be used as a practical and informative guide only and is subject to change without notice. It does not represent a commitment on the part of Cincoze. This product might include unintentional technical or typographical errors. Changes are periodically made to the information herein to correct such errors, and these changes are incorporated into new editions of the publication.

Declaration of Conformity



FCC

This equipment has been tested and found to comply with the limits for a Class A digital device, pursuant to Part 15 of the FCC Rules. These limits are designed to provide reasonable protection against harmful interference when the equipment is operated in a commercial environment. This equipment generates, uses, and can

radiate radio frequency energy and, if not installed and used in accordance with the instruction manual, may cause harmful interference to radio communications. Operation of this equipment in a residential area is likely to cause harmful interference in which case the user will be required to correct the interference at his own expense.



CE

The product(s) described in this manual complies with all application European Union (CE) directives if it has a CE marking. For computer systems to remain CE compliant, only CE-compliant parts may be used. Maintaining CE compliance also requires proper cable and cabling techniques.

Product Warranty Statement

Warranty

Cincoze products are warranted by Cincoze Co., Ltd. to be free from defect in materials and workmanship for 2 years from the date of purchase by the original purchaser. During the warranty period, we shall, at our option, either repair or replace any product that proves to be defective under normal operation. Defects, malfunctions, or failures of the warranted product caused by damage resulting from natural disasters (such as by lightning, flood, earthquake, etc.), environmental and atmospheric disturbances, other external forces such as power line disturbances, plugging the board in under power, or incorrect cabling, and damage caused by misuse, abuse, and unauthorized alteration or repair, and the product in question is either software, or an expendable item (such as a fuse, battery, etc.), are not warranted.

RMA

Before sending your product in, you will need to fill in Cincoze RMA Request Form and obtain an RMA number from us. Our staff is available at any time to provide you with the most friendly and immediate service.

■ RMA Instruction

- Customers must fill in Cincoze Return Merchandise Authorization (RMA) Request Form and obtain an RMA number prior to returning a defective product to Cincoze for service.
- Customers must collect all the information about the problems encountered and note anything abnormal and describe the problems on the “Cincoze Service Form” for the RMA number apply process.
- Charges may be incurred for certain repairs. Cincoze will charge for repairs to products whose warranty period has expired. Cincoze will also charge for repairs to products if the damage resulted from acts of God, environmental or atmospheric disturbances, or other external forces through misuse, abuse, or unauthorized alteration or repair. If charges will be incurred for a repair, Cincoze lists all charges,

and will wait for customer's approval before performing the repair.

- Customers agree to ensure the product or assume the risk of loss or damage during transit, to prepay shipping charges, and to use the original shipping container or equivalent.
- Customers can be sent back the faulty products with or without accessories (manuals, cable, etc.) and any components from the system. If the components were suspected as part of the problems, please note clearly which components are included. Otherwise, Cincoze is not responsible for the devices/parts.
- Repaired items will be shipped along with a "Repair Report" detailing the findings and actions taken.

Limitation of Liability

Cincoze' liability arising out of the manufacture, sale, or supplying of the product and its use, whether based on warranty, contract, negligence, product liability, or otherwise, shall not exceed the original selling price of the product. The remedies provided herein are the customer's sole and exclusive remedies. In no event shall Cincoze be liable for direct, indirect, special or consequential damages whether based on contract of any other legal theory.

Technical Support and Assistance

1. Visit the Cincoze website at www.cincoze.com where you can find the latest information about the product.
2. Contact your distributor or our technical support team or sales representative for technical support if you need additional assistance. Please have following information ready before you call:
 - Product name and serial number
 - Description of your peripheral attachments
 - Description of your software (operating system, version, application software, etc.)
 - A complete description of the problem
 - The exact wording of any error messages

Conventions Used in this Manual



WARNING
(AVERTIR)

This indication alerts operators to an operation that, if not strictly observed, may result in severe injury.

(Cette indication avertit les opérateurs d'une opération qui, si elle n'est pas strictement observée, peut entraîner des blessures graves.)



CAUTION
(ATTENTION)

This indication alerts operators to an operation that, if not strictly observed, may result in safety hazards to personnel or damage to equipment.

(Cette indication avertit les opérateurs d'une opération qui, si elle n'est pas strictement observée, peut entraîner des risques pour la sécurité du personnel ou des dommages à l'équipement.)



NOTE
(NOTE)

This indication provides additional information to complete a task easily.

(Cette indication fournit des informations supplémentaires pour effectuer facilement une tâche.)

Safety Precautions

Before installing and using this device, please note the following precautions.

1. Read these safety instructions carefully.
2. Keep this User's Manual for future reference.
3. Disconnect this equipment from any AC outlet before cleaning.
4. For plug-in equipment, the power outlet socket must be located near the equipment and must be easily accessible.
5. Keep this equipment away from humidity.
6. Put this equipment on a reliable surface during installation. Dropping it or letting it fall may cause damage.
7. Make sure the voltage of the power source is correct before connecting the equipment to the power outlet.
8. Use a power cord that has been approved for using with the product and that it matches the voltage and current marked on the product's electrical range label. The voltage and current rating of the cord must be greater than the voltage and current rating marked on the product.
9. Position the power cord so that people cannot step on it. Do not place anything over the power cord.
10. All cautions and warnings on the equipment should be noted.
11. If the equipment is not used for a long time, disconnect it from the power source to avoid damage by transient overvoltage.
12. Never pour any liquid into an opening. This may cause fire or electrical shock.
13. Never open the equipment. For safety reasons, the equipment should be opened only by qualified service personnel.

If one of the following situations arises, get the equipment checked by service personnel:

- The power cord or plug is damaged.
 - Liquid has penetrated into the equipment.
 - The equipment has been exposed to moisture.
 - The equipment does not work well, or you cannot get it work according to the user's manual.
 - The equipment has been dropped and damaged.
 - The equipment has obvious signs of breakage.
14. CAUTION: Danger of explosion if battery is incorrectly replaced. Replace only with the same or equivalent type recommended by the manufacturer.
 15. Equipment intended only for use in a RESTRICTED ACCESS AREA.
 16. Output of the external power source shall be complied with ES1, PS3 requirements, output rating between 9-48 VDC, minimum 8.5-1.5A, with minimum rated maximum ambient temperature 70°C, and has to be evaluated according to IEC/EN 60950-1 and/or IEC/EN 62368-1. If need further assistance, please contact Cincoze for further information.
 17. Ensure to connect the power cord of power adapter to a socket-outlet with earthing connection.
 18. Dispose of used battery promptly. Keep away from children. Do not disassemble and do not dispose of in fire.

Package Contents

Before installation, please ensure all the items listed in the following table are included in the package.

Item	Description	Q'ty
1	DV-1100 Embedded System	1
2	CPU Installation Kit	1
3	External Fan Terminal Block Connector	1
4	Screw Pack	1
5	Wall Mounting Kit	1
6	Power Terminal Block Connector	1
7	Remote Function Terminal Block Connector	2
8	M.2 Key B Type 3052 to Type 3042 Adapter Bracket	1

Note: Notify your sales representative if any of the above items are missing or damaged.

Ordering Information

Model No.	Product Description
DV-1100-R10	13/12th Gen. Intel® Core™ Series High Performance and Basic Function Rugged Embedded Computer



Chapter 1

Product Introductions

1.1 Overview

The DV-1100 is a compact, high-performance, embedded edge computer that supports 13th/12th generation Intel® processors. Its balance between high-performance computing needs and cost-effectiveness enables enterprises to quickly analyze and process edge data for better decision-making and improved production efficiency and accuracy. The DV-1100 is ideal for smart manufacturing, machine vision, railway computing, and space-constrained applications where stability and reliability are paramount.

Key Features

- Intel® 13/12th Gen. Core™ i9/i7/i5/i3 Processors (max 65 W TDP)
- 1x M.2 Key M Type 2280 Socket for PCIe Gen 4x4 NVMe Storage
- 1x M.2 Key E Type 2230 Socket for Wireless/Intel CNVi Module Expansion
- 1x M.2 Key B Type 3052/3042 Socket for 5G/Storage/Add-on Card Expansion
- 1x M.2 Key B Type 2242 Socket for Storage/Add-on Card Expansion
- Optional CMI & CFM Modules for I/O Expansion & Power Ignition Sensing Function
- Wide operating temperature -40°C to 70°C

Certification



EN 50121-3-2



EN 61000-6-2



EN 61000-6-4



MIL-STD-810H

Balancing Performance and Cost

The DV-1100 has a compact body and supports a 13th /12th generation Intel® Core™ processor. It provides sufficient computing performance for multitasking and diverse applications while balancing performance and cost.

13 / 12th Gen

Intel Core Series



Compact Size

The DV-1100 measures only 224.1 x 162 x 62mm, making it easy to install anywhere, including in space-constrained applications

Stunning Transfer and Access Speeds

The DV-1100 has high-speed I/O interfaces, including 2.5G LAN and 10Gbps USB 3.2 Gen2x1. Storage support includes 2.5" HDD/SSD and high-speed NVMe SSD.

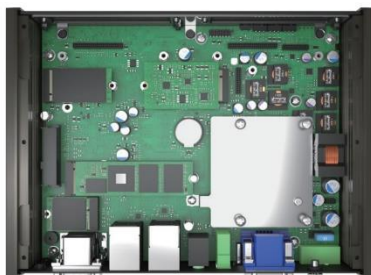

Excellent Extension Design

The DV-1100 has built-in M.2 Key B, M.2 Key E, and M.2 Key M slots for flexible wireless (5G, Wi-Fi, GNSS) and storage selection according to application requirements.

Various Industry Certifications

The DV-1100's rugged design meets various industrial-grade and industrial certifications, such as EMC standards in industrial environments (EN 61000-6-2/4), US military shock vibration standards (MIL-STD-810H), railway computing EN50155 (EN 50121-3-2 only), and more.



1.2 Hardware Specification

Model Name	DV-1100
System	
Processor	<ul style="list-style-type: none"> • 13th Generation Intel® Raptor Lake-S Series CPU: <ul style="list-style-type: none"> - Intel® Core™ i9-13900E 24 Cores Up to 5.2 GHz, TDP 65W - Intel® Core™ i7-13700E 16 Cores Up to 5.1 GHz, TDP 65W - Intel® Core™ i5-13500E 14 Cores Up to 4.6 GHz, TDP 65W - Intel® Core™ i5-13400E 10 Cores Up to 4.6 GHz, TDP 65W - Intel® Core™ i3-13100E 4 Cores Up to 4.4 GHz, TDP 60W - Intel® Core™ i9-13900TE 24 Cores Up to 5.0 GHz, TDP 35W - Intel® Core™ i7-13700TE 16 Cores Up to 4.8 GHz, TDP 35W - Intel® Core™ i5-13500TE 14 Cores Up to 4.5 GHz, TDP 35W - Intel® Core™ i3-13100TE 4 Cores Up to 4.1 GHz, TDP 35W • 12th Generation Intel® Alder Lake-S Series CPU: <ul style="list-style-type: none"> - Intel® Core™ i9-12900E 16 Cores Up to 5.0 GHz, TDP 65W - Intel® Core™ i7-12700E 12 Cores Up to 4.8 GHz, TDP 65W - Intel® Core™ i5-12500E 6 Cores Up to 4.5 GHz, TDP 65W - Intel® Core™ i3-12100E 4 Cores Up to 4.2 GHz, TDP 60W - Intel® Core™ i9-12900TE 16 Cores Up to 4.8 GHz, TDP 35W - Intel® Core™ i7-12700TE 12 Cores Up to 4.7 GHz, TDP 35W - Intel® Core™ i5-12500TE 6 Cores Up to 4.3 GHz, TDP 35W - Intel® Core™ i3-12100TE 4 Cores Up to 4.0 GHz, TDP 35W - Intel® Pentium® G7400E 2 Cores Up to 3.6 GHz, TDP 46W - Intel® Pentium® G7400TE 2 Cores Up to 3.0 GHz, TDP 35W - Intel® Celeron® G6900E 2 Cores Up to 3.0 GHz, TDP 46W - Intel® Celeron® G6900TE 2 Cores Up to 2.4 GHz, TDP 35W
Chipset	<ul style="list-style-type: none"> • Intel H610E Chipset
Memory	<ul style="list-style-type: none"> • 1x DDR5 4800Mhz SO-DIMM Socket Supports Un-buffered and non-ECC Type, Up to 32GB
BIOS	<ul style="list-style-type: none"> • AMI BIOS
Graphics	
Graphics Engine	<ul style="list-style-type: none"> • Integrated Intel® UHD Graphics 770: Core™ i9/i7/i5 • Integrated Intel® UHD Graphics 730: Core™ i3 • Integrated Intel® UHD Graphics 710: Pentium®/Celeron®
Maximum Display Output	<ul style="list-style-type: none"> • Supports Triple Independent Display
DP	<ul style="list-style-type: none"> • 1x DisplayPort Connector: 3840 x 2160 @60Hz
VGA	<ul style="list-style-type: none"> • 1x VGA Connector: 1920 x 1200 @60Hz
CMI Display	<ul style="list-style-type: none"> • 1x CMI Interface for Optional CMI-DP/CMI-HDMI Module Expansion

Audio	
Audio Codec	<ul style="list-style-type: none"> • Realtek® ALC888, High Definition Audio
Line-out	<ul style="list-style-type: none"> • 1x Line-out, Phone Jack 3.5mm
Mic-in	<ul style="list-style-type: none"> • 1x Mic-in, Phone Jack 3.5mm
I/O	
LAN	<ul style="list-style-type: none"> • 1x 2.5GbE LAN, RJ45 - Intel® I225 • 1x 1GbE LAN, RJ45 - Intel® I219
COM	<ul style="list-style-type: none"> • 2x RS-232/422/485 with Auto Flow Control (Supports 5V/12V), DB9
USB	<ul style="list-style-type: none"> • 1x 10Gbps USB3.2 Gen 2x1, Type A • 2x 5Gbps USB 3.2 Gen 1x1, Type A • 3x 480Mbps USB2.0, Type A
Storage	
SSD/HDD	<ul style="list-style-type: none"> • 1x 2.5" SATA HDD/SSD Bay (SATA 3.0)
M.2 SSD	<ul style="list-style-type: none"> • 1x M.2 SSD Shared by M.2 Key M Type 2280 Socket, Support PCIe Gen 4x4 NVMe SSD or SATA 3.0 SSD • 2x M.2 SSD Shared by M.2 Key B Socket, Support PCIe Gen 3x2 NVMe SSD or SATA 3.0 SSD
Expansion	
M.2 Key E Socket	<ul style="list-style-type: none"> • 1x M.2 Key E Type 2230 Socket, Support Wireless/Intel CNVi Module Expansion
M.2 Key B Socket	<ul style="list-style-type: none"> • 1x M.2 Key B Type 3042/3052 Socket, Support 5G/Storage/Add-on Card Expansion • 1x M.2 Key B Type 2242 Socket, Support Storage/Add-on Card Expansion
SIM Socket	<ul style="list-style-type: none"> • 1 x Front Accessible SIM Socket
CMI (Combined Multiple I/O) Interface	<ul style="list-style-type: none"> • 1x CMI Interface for optional CMI-Display Module Expansion • 2x CMI Interface for optional CMI-COM/DIO Module Expansion
CFM (Control Function Module) Interface	<ul style="list-style-type: none"> • 1x CFM IGN Interface for optional CFM-IGN Module Expansion
Other Function	
External FAN Connector	<ul style="list-style-type: none"> • 1x External FAN Connector, 4-pin Terminal Block (Support Smart Fan by BIOS)
Clear CMOS Switch	<ul style="list-style-type: none"> • 1x Clear CMOS Switch
Reset Button	<ul style="list-style-type: none"> • 1x Reset Button
Instant Reboot	<ul style="list-style-type: none"> • Support 0.2sec Instant Reboot Technology
Watchdog Timer	<ul style="list-style-type: none"> • Software Programmable Supports 256 Levels System Reset
Antenna	<ul style="list-style-type: none"> • 5x Antenna Holes
Power	
Power Button	<ul style="list-style-type: none"> • 1x ATX Power On/Off Button
Power Mode Switch	<ul style="list-style-type: none"> • 1x AT/ATX Mode Switch
Power Input	<ul style="list-style-type: none"> • 9-48VDC, 3-pin Terminal Block
Remote Power On/Off	<ul style="list-style-type: none"> • 1x Remote Power On/Off, 2-pin Terminal Block
Remote Power LED	<ul style="list-style-type: none"> • 1x Remote Power LED, 2-pin Terminal Block

Physical	
Dimension (W x D x H)	• 224.1 x 162 x 62 mm
Weight Information	• 2.52 KG
Mechanical Construction	• Extruded Aluminum with Heavy Duty Metal
Mounting	• Wall / DIN-RAIL / VESA Mount
Physical Design	<ul style="list-style-type: none"> • Fanless Design • Cableless Design • Jumper-less Design • Unibody Design
Reliability & Protection	
Reverse Power Input Protection	• Yes
Over Voltage Protection	<ul style="list-style-type: none"> • Protection Range: 51-58V • Protection Type: shut down operating voltage, re-power on at the present level to recover
Over Current Protection	• 15A
CMOS Battery Backup	• SuperCap Integrated for CMOS Battery Maintenance-free Operation
MTBF	• 413,236 Hours - Database: Telcordia SR-332 Issue3, Method 1, Case 3
Operating System	
Windows	• Windows®11, Windows®10
Linux	• Ubuntu 22.04
Environment	
Operating Temperature	<ul style="list-style-type: none"> • 35W TDP Processor: -40°C to 70°C • 65W TDP Processor: -40°C to 55°C (With External Fan Kit) * PassMark BurnInTest: 100% CPU, 2D/3D Graphics (without thermal throttling) * With extended temperature peripherals; Ambient with air flow * According to IEC60068-2-1, IEC60068-2-2, IEC60068-2-14
Storage Temperature	• -40°C to 70°C
Relative Humidity	• 95%RH @ 70°C (Non-condensing)
Shock	• MIL-STD-810H
Vibration	• MIL-STD-810H
EMC	<ul style="list-style-type: none"> • CE, UKCA, FCC, ICES-003 Class A • EN IEC 61000-6-4 / EN IEC 61000-6-2 (24VDC Input Only) • EN 50155 (EN 50121-3-2 Only) • E-mark (Pending)
EMI	<ul style="list-style-type: none"> • CISPR 32 Conducted & Radiated: Class A • EN/BS EN 50121-3-2 Conducted & Radiated: Class A • EN/BS EN IEC 61000-3-2 Harmonic current emissions: Class A • EN/BS EN 61000-3-3 Voltage fluctuations & flicker • FCC 47 CFR Part 15B, ICES-003 Conducted & Radiated: Class A
EMS	<ul style="list-style-type: none"> • EN/IEC 61000-4-2 ESD: Contact: 6 kV; Air: 8 kV • EN/IEC 61000-4-3 RS: 80 MHz to 1000 MHz: 20 V/m

- | | |
|--|----------------------------------------------------------------------------------------------------------------------------------------------------------------------------------------------------------------------------------------------------------------------------------------------------------------------------------------------------------------------------------------------------------------------------|
| | <ul style="list-style-type: none">• EN/IEC 61000-4-4 EFT: AC Power: 2 kV; DC Power: 2 kV; Signal: 2 kV• EN/IEC 61000-4-5 Surges: AC Power: 2 kV; Signal: 1 kV• EN/IEC 61000-4-6 CS: 10V (**Compliant with the standard when utilizing shielded cable.)• EN/IEC 61000-4-8 PFMF: 50 Hz, 30A• EN/IEC 61000-4-11 Voltage Dips & Voltage Interruptions: 1 cycles at 60 Hz |
|--|----------------------------------------------------------------------------------------------------------------------------------------------------------------------------------------------------------------------------------------------------------------------------------------------------------------------------------------------------------------------------------------------------------------------------|

** Product Specifications and features are for reference only and are subject to change without prior notice. For more information, please refer to the latest product datasheet from Cincoze's website.*

1.3 External Layout

1.3.1 Front

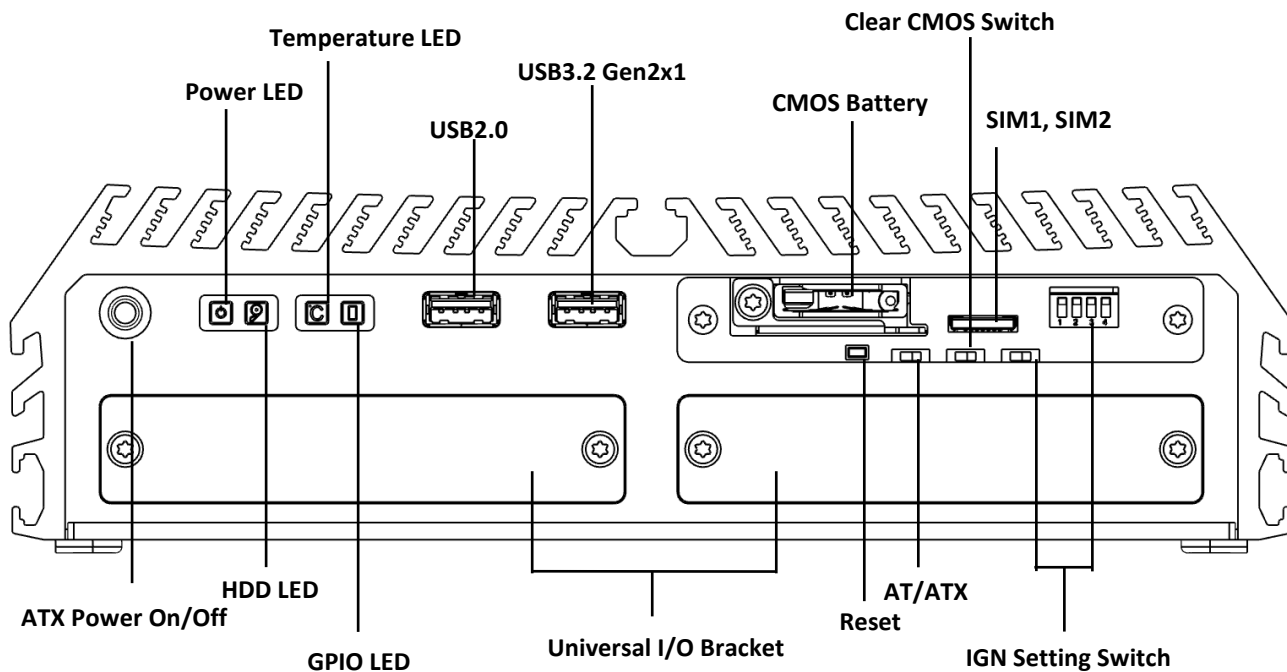

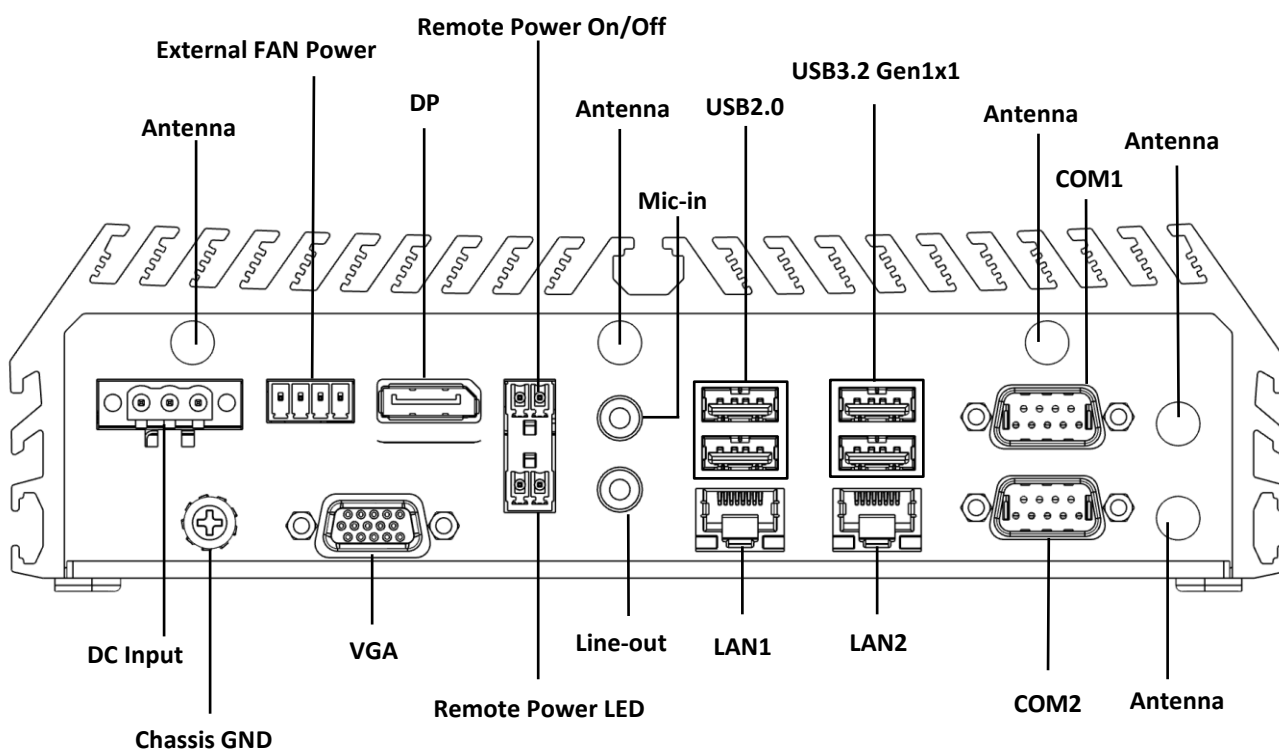

1.3.2 Rear

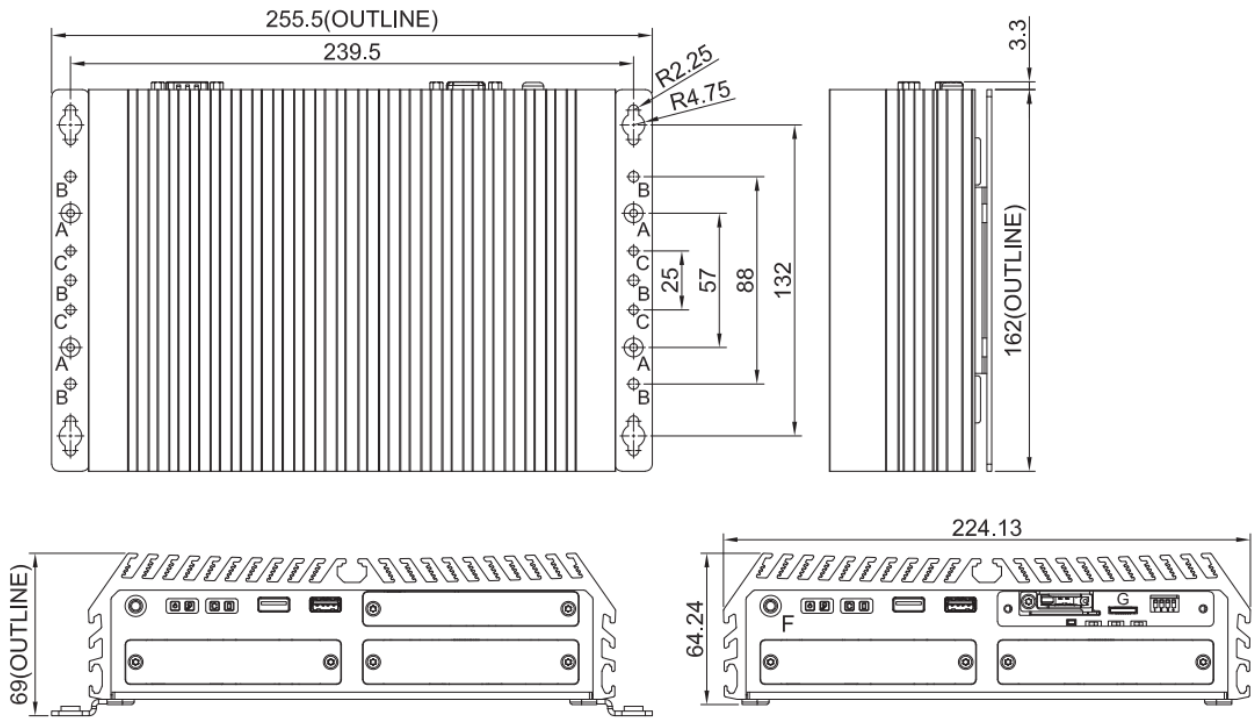

1.4 Dimensions

Unit: mm





Chapter 2

Switches & Connectors

2.1 Location of Switches and Connectors

2.1.1 Top View

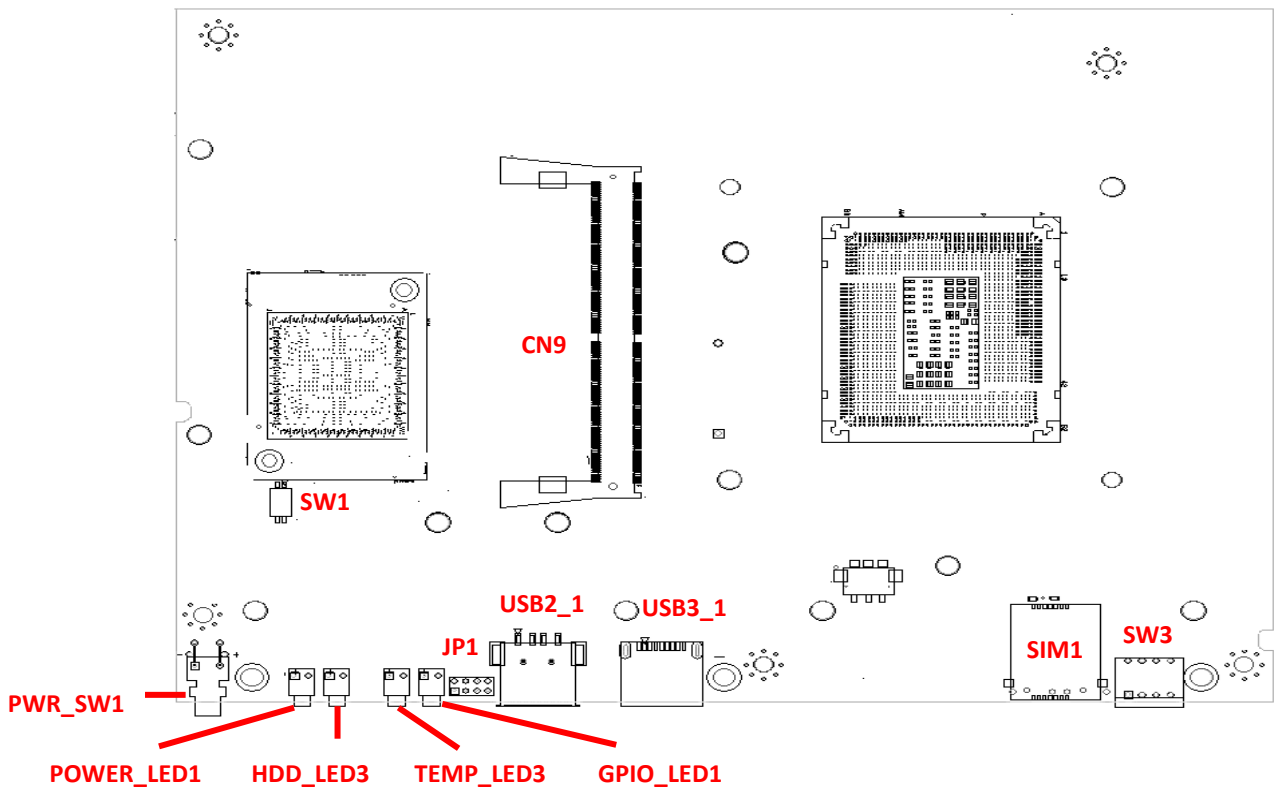

2.1.2 Bottom View

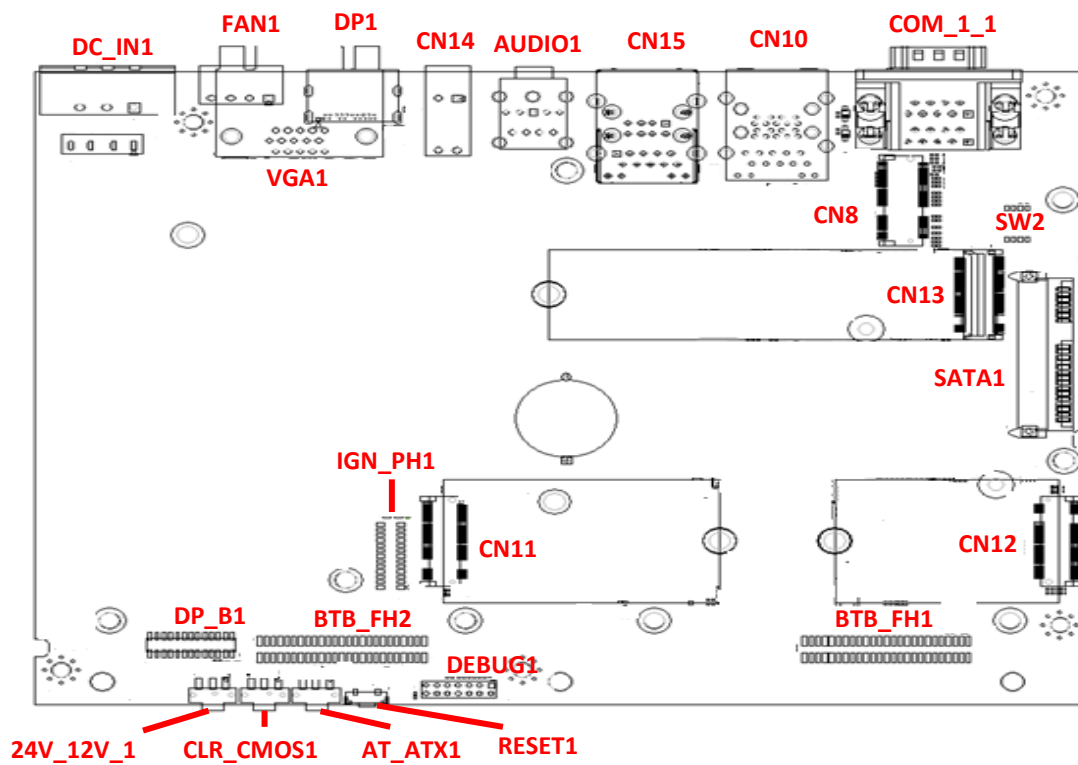

2.2 Switches and Connectors Definition

Location	Definition
AT_ATX1	AT / ATX Power Mode Switch
AUDIO1	Headphone and Mic Connector
BTB_FH1	DIO or COM Port3/4 Board to Board Connector
BTB_FH2	DIO or COM Port5/6 Board to Board Connector
CN8	M.2 Key E Type 2230 Connector (Support PCIE /USB2/CNVi)
CN9	DDR5 SO-DIMM Connector
CN10	LAN2(I225-IT) and USB3.2 GEN1x1 Ports (2Ports)
CN11	M.2 Key B Type 3052 Connector (Support PCIE/SATA/USB3/USB2/ Dual Nano SIM Card)
CN12	M.2 Key B Type 2242 Connector, (Support PCIE/SATA/USB2)
CN13	M.2 Key M Type 2280 Connector (Support PCIe4 /SATA)
CN14	Remote power on/off Switch Connector and Remote Power LED Connector
CN15	LAN1(I219-LM) and USB2.0 Ports(2Ports)
COM_1_1	COM1 and COM2 Connector
CLR_CMOS1	Clear CMOS Setting Switch
DC_IN1	3 Pins DC 9-48V Power Input with Power Ignition Connector
DP_B1	CMI 26 pins slot (Support CMI for HDMI, DP)
DP1	Display Port Connector
FAN1	CPU Smart Fan Connector
GPIO_LED1	GPIO LED
HDD_LED3	SATA LED and KEY B SSD LED
IGN_PH1	IGN Module Board to Board Connector
JP1	SPI Programmer Connector
POWER_LED1	Power LED
PWR_SW1	System Power Button
RESET1	System Reset Button
SATA1	2.5" SATA HDD/SSD Connector
SIM1	SIM Card Connector
SW1	Super CAP Power Control Switch
SW2	COM1 and COM2 Power Select Switch
SW3	IGN Module Timing Setting Switch
TEMP_LED3	TEMP LED
USB2_1	USB2.0 TYPE A Connector
USB3_1	USB3.2 GEN2x1 TYPE A Connector
VGA1	VGA Connector
24V_12V_1	IGN Module Voltage Mode Setting Switch

2.3 Switches Definition

AT_ATX1: AT / ATX Power Mode Switch

Switch	Definition
Left	AT Power Mode
Right	ATX Power Mode (Default)



CN10: LAN2(I225-IT) and USB3.2 GEN1x1 Ports (2Ports)

LAN LED Status Definition

Link LED Status	Definition
Steady Green	2.5 Gbps Network Link
Steady Orange	1 Gbps Network Link
Off	100 Mbps/ 10 Mbps Network Link
Act LED Status	Definition
Blinking Yellow	Data Activity
Steady Yellow	No Activity

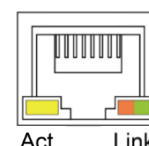

CN15: LAN1(I219-LM) and USB2.0 Ports(2Ports)

LAN LED Status Definition

Link LED Status	Definition
Steady Green	1 Gbps Network Link
Steady Orange	100 Mbps Network Link
Off	10 Mbps Network Link
Act LED Status	Definition
Blinking Yellow	Data Activity
Steady Yellow	No Activity

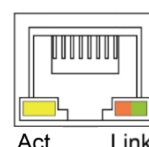

CLR_CMOS1: Clear CMOS Setting Switch

Switch	Definition
Left	Normal (Default)
Right	Clear CMOS



WARNING
(AVERTIR)

After performing Clear CMOS, the system will take several minutes to start. This is normal. During this process, the system will POST three times, and the system's Power LED will alternate between green and blue lights.

(Après avoir effectué Clear CMOS, le système prendra plusieurs minutes pour démarrer. Cela est normal. Pendant ce processus, le système effectuera trois fois le POST, et la LED d'alimentation du système alternera entre les lumières verte et bleue.)

POWER_LED1: Power LED Status

Location	Status	LED Color
Power_LED1	Power ON	Green
	Standby	Blinking Green



HDD_LED3: SATA LED and KEY B SSD LED

Location	Status	LED Color
HDD_LED3	Storage Read/Write	Blinking Yellow

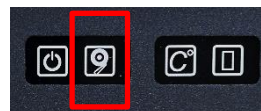

TEMP_LED3: Temperature LED Status

Location	Status	LED Color
TEMP_LED3	System Temp $\leq 65^{\circ}\text{C}$	Colorless
	$65^{\circ}\text{C} < \text{System Temp} \leq 70^{\circ}\text{C}$	Blue
	$70^{\circ}\text{C} < \text{System Temp} \leq 75^{\circ}\text{C}$	Red
	$75^{\circ}\text{C} < \text{System Temp}$	Blinking Red



GPIO_LED1: GPIO LED Status

Location	Status	LED Color
GPIO_LED1	GPIO activity	Green
	No activity	Off



PWR_SW1: System Power Button

Switch	Definition
Push	Power up the System



RESET1: System Reset Button

Switch	Definition
Push	Reset System



SW1: Super CAP Control Switch

Location	Function	DIP1	DIP2
SW1	Super CAP Enabled	ON (Default)	ON (Default)
	Super CAP Disabled	OFF	

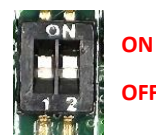

SW2: COM1 and COM2 Power Select Switch

Location	Function		DIP1	DIP2
SW2	COM1	RI	ON (Default)	ON (Default)
		5V	ON	OFF
		12V	OFF	OFF
Location	Function		DIP3	DIP4
SW2	COM2	RI	ON (Default)	ON (Default)
		5V	ON	OFF
		12V	OFF	OFF

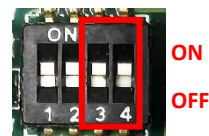
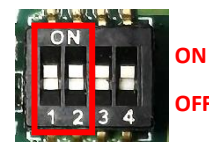

SW3 : IGN Module Timing Setting Switch

Set shutdown delay timer when ACC is turned off.

This switch functions only when applying CFM-IGN04 module.

DIP1	DIP 2	DIP 3	DIP 4	Definition
ON (IGN Enabled)	ON	ON	ON	0 second
	ON	ON	OFF	1 minute
	ON	OFF	ON	5 minutes
	ON	OFF	OFF	10 minutes
/	OFF	ON	ON	30 minutes
	OFF	ON	OFF	1 hour
	OFF	OFF	ON	2 hours
	OFF	OFF	OFF	Reserved (0 second)



Default setting of Pin1 to Pin4 is OFF / OFF / OFF / OFF.

24V_12V_1 : IGN Module Voltage Mode Setting Switch

12V / 24V Car Battery Switch.

This switch functions only when applying CFM-IGN04 module.

Switch	Definition
Left	12V Car Battery Input
Right	24V Car Battery Input (Default)



2.4 Definition of Connectors

CN8 : M.2 Key E Connector (Support PCIE/USB2/ CNVi)

Pin No.	PIN Name	Pin No.	Pin name
1	GND	2	+3.3V
3	USB2_D+	4	+3.3V
5	USB2_D-	6	NC
7	GND	8	PCM_CLK
9	WGR_D1N	10	PCM_SYNC
11	WGR_D1P	12	PCM_IN
13	GND	14	PCM_OUT
15	WGR_D0N	16	NC
17	WGR_D0P	18	GND
19	GND	20	UART_WAKE#
21	WGR_CLKN	22	BRI_RSP
23	WGR_CLKP	24	Key
25	Key	26	Key
27	Key	28	Key
29	Key	30	Key
31	Key	32	RGI_DT
33	GND	34	RGI_RSP
35	PETp0	36	BRI_DT
37	PETn0	38	CLINK_REST
39	GND	40	CLINK_DATA
41	PERp0	42	CLINK_CLK
43	PERn0	44	COEX3
45	GND	46	COEX2
47	REFCLKP0	48	COEX1
49	REFCLKN0	50	SUSCLK
51	GND	52	PERSTO#
53	CLKREQ0#	54	W_DISABLE2#
55	PEWAKE0#	56	W_DISABLE1#
57	GND	58	I2C_DATA
59	WTD1N/PETP1	60	I2C_CLK
61	WTD1N/PETN1	62	NC
63	GND	64	NC
65	WTDON/PERP1	66	NC
67	WTDOP/PERN1	68	NC
69	GND	70	PEWAKE1#

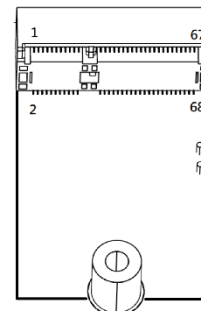

71	WTCLKN/REFCLKP1	72	+3.3V
73	WTCLKP/REFCLKN1	74	+3.3V
75	GND		

CN11 : M.2 Key B Type 3052 Connector (Support PCIE/SATA/USB3/USB2/ Dual Nano SIM Card)

Pin No.	PIN Name	Pin No.	Pin name
1	CFG3	2	+3.3V
3	GND	4	+3.3V
5	GND	6	FULL_CARD_POWER_OFF_N
7	USB2_D+	8	W_DISABLE1_N
9	USB2_D-	10	LED1_N
11	GND	12	Key
13	Key	14	Key
15	Key	16	Key
17	Key	18	Key
19	Key	20	GPIO_5
21	CFG0	22	GPIO_6
23	NC	24	GPIO_7
25	NC	26	GPIO_10
27	GND	28	GPIO_8
29	PERn1 /USB3_RX-	30	USIM_RESET
31	PERp1 /USB3_RX+	32	USIM_CLK
33	GND	34	USIM_DATA
35	PETn1 /USB3_TX-	36	USIM_PWR
37	PETp1 /USB3_TX+	38	DEVSLP
39	GND	40	USIM_DET2
41	PERn0 /SATA_B+	42	USIM_DATA2
43	PERp0 /SATA_B-	44	USIM_CLK2
45	GND	46	USIM_RESET2
47	PETn0 /SATA_A-	48	USIM_PWR2
49	PETp0 /SATA_A+	50	PERST#
51	GND	52	CLKREQ#
53	REFCLKN	54	PEWAKE#
55	REFCLKP	56	NC
57	GND	58	NC
59	NC	60	COEX3
61	NC	62	COEX2
63	NC	64	COEX1
65	NC	66	USIM_DET

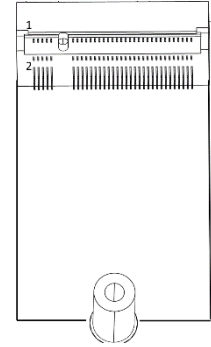

67	RESET#	68	SUSCLK
69	CFG1	70	+3.3V
71	GND	72	+3.3V
73	GND	74	+3.3V
75	CFG2		

CN12 : M.2 Key B Type 2242 Connector (Support PCIE/SATA/USB2)

Pin No.	PIN Name	Pin No.	Pin name
1	CFG3	2	+3.3V
3	GND	4	+3.3V
5	GND	6	FULL_CARD_POWER_OFF_N
7	USB2_D+	8	W_DISABLE1_N
9	USB2_D-	10	LED1_N
11	GND	12	Key
13	Key	14	Key
15	Key	16	Key
17	Key	18	Key
19	Key	20	GPIO_5
21	CFG0	22	GPIO_6
23	NC	24	GPIO_7
25	NC	26	GPIO_10
27	GND	28	GPIO_8
29	PERn1	30	NC
31	PERp1	32	NC
33	GND	34	NC
35	PETn1	36	NC
37	PETp1	38	DEVSLP
39	GND	40	NC
41	PERn0 /SATA_B+	42	NC
43	PERp0 / SATA_B-	44	NC
45	GND	46	NC
47	PETn0 /SATA_A-	48	NC
49	PETp0 / SATA_A+	50	PERST#
51	GND	52	CLKREQ#
53	REFCLKN	54	PEWAKE#
55	REFCLKP	56	NC
57	GND	58	NC
59	NC	60	COEX3
61	NC	62	COEX2

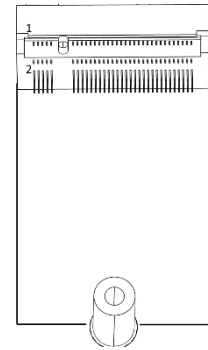

63	NC	64	COEX1
65	NC	66	NC
67	RESET#	68	SUSCLK
69	CFG1	70	+3.3V
71	GND	72	+3.3V
73	GND	74	+3.3V
75	CFG2		

CN13 : M.2 Key M Type 2280 Connector (Support PCIe4 /SATA)

Pin No.	PIN Name	Pin No.	Pin name
1	CFG3	2	+3.3V
3	GND	4	+3.3V
5	PERn3	6	NC
7	PERp3	8	NC
9	GND	10	LED1#
11	PETn3	12	+3.3V
13	PETp3	14	+3.3V
15	GND	16	+3.3V
17	PERn2	18	+3.3V
19	PERp2	20	NC
21	GND	22	NC
23	PETn2	24	NC
25	PETp2	26	NC
27	GND	28	NC
29	PERn1	30	NC
31	PERp1	32	NC
33	GND	34	NC
35	PETn1	36	NC
37	PETp1	38	DEVSLP
39	GND	40	SMB_CLK
41	PERn0 /SATA_B+	42	SMB_DATA
43	PERp0 / SATA_B-	44	ALERT#
45	GND	46	NC
47	PETn0 /SATA_A-	48	NC
49	PETp0 / SATA_A+	50	PERST#
51	GND	52	CLKREQ#
53	REFCLKN	54	PEWAKE#
55	REFCLKP	56	NC

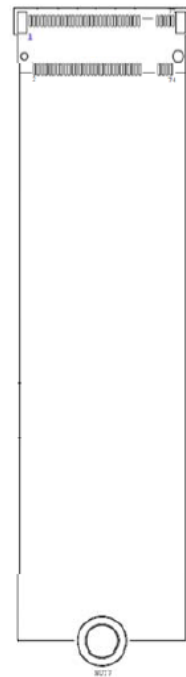

57	GND	58	NC
59	Key	60	Key
61	Key	62	Key
63	Key	64	Key
65	Key	66	Key
67	NC	68	SUSCLK
69	PEDET/CFG1	70	+3.3V
71	GND	72	+3.3V
73	GND	74	+3.3V
75	GND		

CN14: Remote power on/off Switch Connector and Remote Power LED Connector

Remote Power LED connector can only connect an external LED indicator up to 10mA.

Connector Type: Terminal Block 2X2 4-pin, 3.5mm pitch

Pin	Definition
1	PWR_SW
2	REMOPOWER_LED
3	GND
4	GND

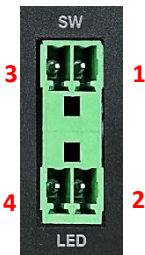

WARNING
(AVERTIR)

Do not apply power to this connector! This port is used to connect a SWITCH!
(Ne mettez pas sous tension ce connecteur! Ce port est utilisé pour connecter un SWITCH!)

FAN1: CPU Smart Fan Connector

Connector Type: Terminal Block 1X4 4-pin, 3.5mm pitch

Pin	Definition
1	GND
2	+12V
3	SENSE
4	Control

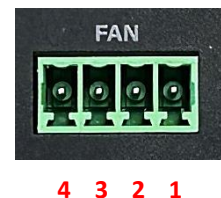

COM_1_1: COM1 and COM2 Connector (Support RS232/RS422/RS485)

Connector Type: 9-pin D-Sub

Pin	RS232 Definition	RS422 / 485 Full Duplex Definition	RS485 Half Duplex Definition
1	DCD	TX-	DATA -
2	RXD	TX+	DATA +
3	TXD	RX+	
4	DTR	RX-	
5	GND		
6	DSR		
7	RTS		
8	CTS		
9	RI		



DC_IN1: 3 Pins DC 9-48V Power Input with Power Ignition Connector

Connector Type: Terminal Block 1x3 3-pin, 5.0mm pitch

Pin	Definition
1	+9-48VIN
2	Ignition (IGN)
3	GND



1 2 3



CAUTION

**CAUTION
(ATTENTION)**

Please disconnect the power source before mounting the DC power cables or connecting the DC power connector to system.

(Veuillez débrancher la source d'alimentation avant de monter les câbles d'alimentation CC ou de connecter le connecteur d'alimentation CC au système.)

2.5 Optional Module: Definition of Switches and Connectors

2.5.1 CMI-COM06 Module



The CMI-COM06 module can be installed at the BTB_FH1 connector, the BTB_FH2 connector, or both. If installed at BTB_FH1, the corresponding COM numbers are COM3 and COM4. If installed at BTB_FH2, the corresponding COM numbers are COM5 and COM6. When two CMI-COM06 modules are installed at both BTB_FH1 and BTB_FH2, the COM numbers range from COM3 to COM6 as shown in the following DV-1100 Front Bezel Diagram.

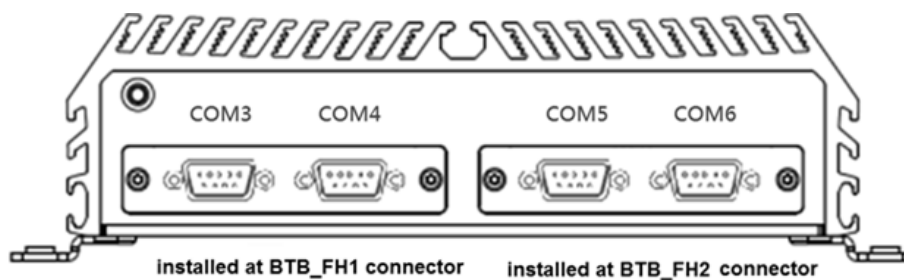

COM1 and COM2 (on the module) : COM3 and COM4 Connector (Support RS232/RS422/RS485)

Connector Type: 9-pin D-Sub

Pin	RS232 Definition	RS422 / 485 Full Duplex Definition	RS485 Half Duplex Definition
1	DCD	TX-	DATA -
2	RXD	TX+	DATA +
3	TXD	RX+	
4	DTR	RX-	
5	GND		
6	DSR		
7	RTS		
8	CTS		
9	RI		



SW1 (on the module) : COM3/COM5 Power Select Switch

Location	Function		DIP1	DIP2
SW1	COM3/5	RI	ON (Default)	ON (Default)
		5V	ON	OFF
		12V	OFF	OFF

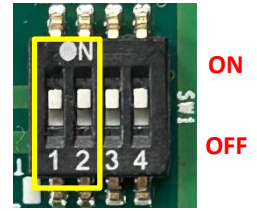

SW1 (on the module) : COM4/COM6 Power Select Switch

Location	Function		DIP3	DIP4
SW1	COM4/6	RI	ON (Default)	ON (Default)
		5V	ON	OFF
		12V	OFF	OFF

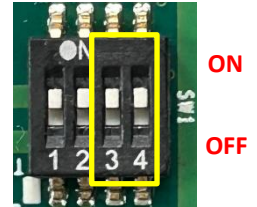

2.5.2 CMI-DIO06 Module

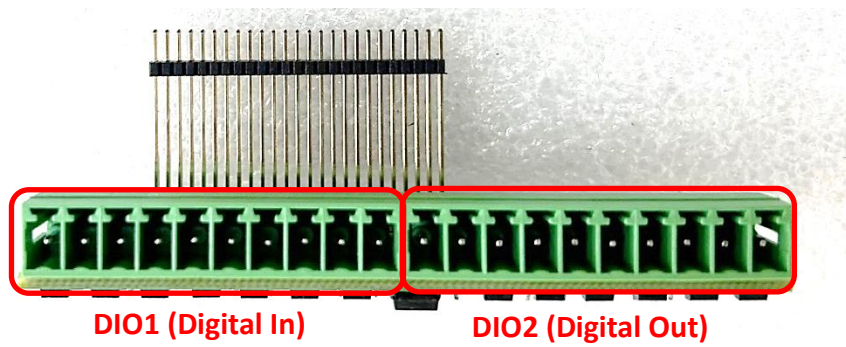

DIO1 (on the module): Digital IN Connector

Connector Type: Terminal Block 1X10 10-pin, 3.5mm pitch

Pin	Definition	Pin	Definition
1	XCOM+ (DC INPUT)	6	DI5
2	DI1	7	DI6
3	DI2	8	DI7
4	DI3	9	DI8
5	DI4	10	XCOM- (GND)



DIO2 (on the module) : Digital OUT Connector

Connector Type: Terminal Block 1X10 10-pin, 3.5mm pitch

Pin	Definition	Pin	Definition
1	XCOM+ (DC INPUT)	6	DO5
2	DO1	7	DO6
3	DO2	8	DO7
4	DO3	9	DO8
5	DO4	10	XCOM- (GND)

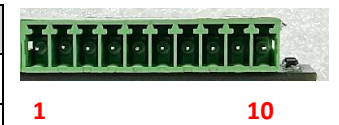



Chapter 3

System Setup

3.1 Removing Top Cover



WARNING
(AVERTIR)

In order to prevent electric shock or system damage, must turn off power and disconnect the unit from power source before removing the chassis cover.

(Afin d'éviter tout risque d'électrocution ou d'endommagement du système, vous devez couper l'alimentation et débrancher l'appareil de la source d'alimentation avant de retirer le couvercle du châssis.)

Step 1: Loosen the 6 screws on the bottom panel of the system.



Step 2. Remove the bottom panel and then the system body from the chassis.



Step 3. Loosen the indicated 2 screws (M3x4).

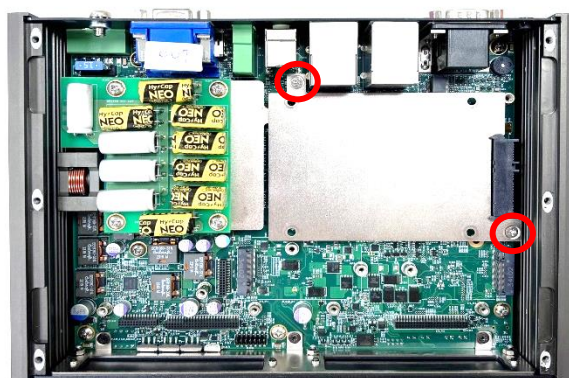

Step 4. Loosen the six red-indicated screws (M3x6) and the orange-indicated screw (M3x8).

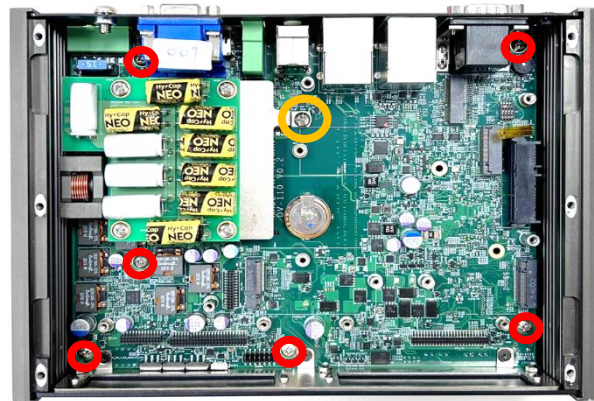

Step 5. Remove the system body from the top cover.

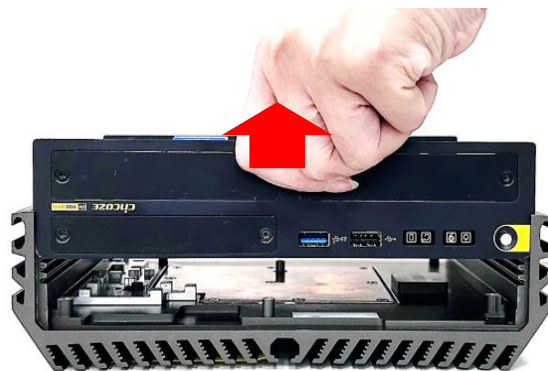

Step 6. Place the system body aside gently.

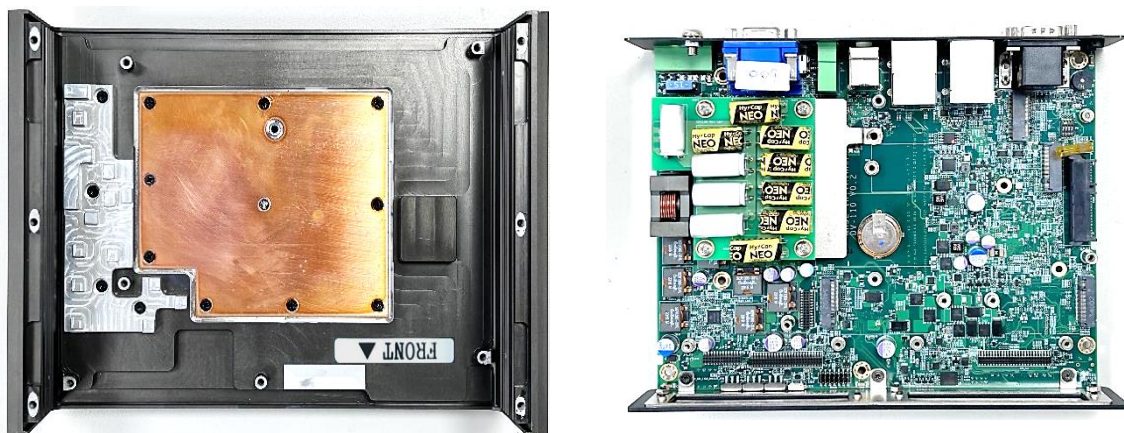

Step 7. Carefully turn over the unit and place it gently. If the thermal pads stick to the top cover after disassembly, please reattach them to the mainboard as shown in the photo.

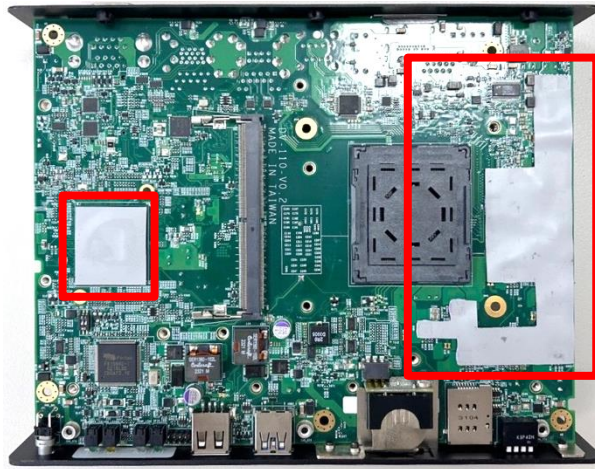

3.2 Installing Antenna

Install antennas on positions 1, 2, and 3 (from the PCB top side) before installing the CPU to prevent thermal paste from spreading. Antennas in positions 4 and 5 can be installed before or after CPU and the top cover installation.



Step 1. Remove the antenna plug on the rear panel.



Step 2. Penetrate the antenna jack through the hole.

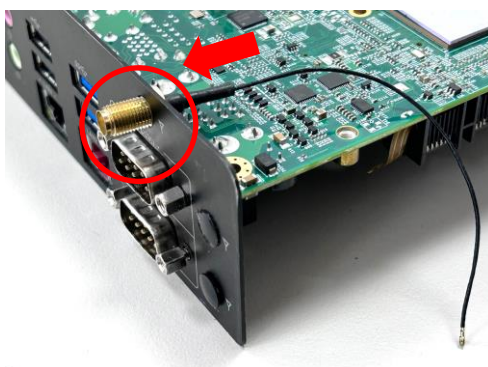

Step 3. Put on the washer and fasten the nut of antenna jack.

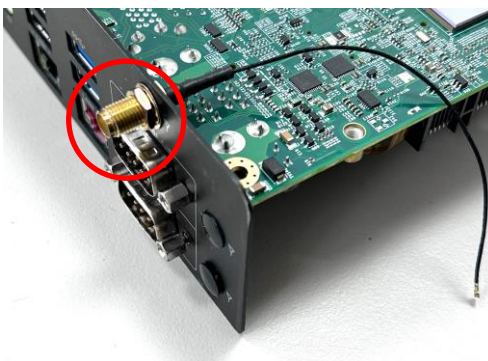

Step 4. Assemble the antenna and antenna jack together.



Step 5. Remember to attach the RF connector of the cable's another end onto the wireless card after wireless card's installation.



3.3 Installing CPU



WARNING
(AVERTIR)

After replacing the CPU, please perform a Clear CMOS before powering on. According to Intel documentation (Clear CMOS after Hardware Configuration Change, Document Number: 337986-001), if you do not perform a Clear CMOS, the BIOS will apply settings from the old CPU to the new CPU, which may cause performance issues or startup failures. Therefore, Cincoze performs a Clear CMOS procedure before shipping. When customers power on the system for the first time, it will take several minutes to start. This is normal. During this process, the system will POST three times, and the Power LED will alternate between green and blue lights.

(Après avoir remplacé le CPU, veuillez effectuer un Clear CMOS avant de mettre sous tension. Selon la documentation Intel (Clear CMOS after Hardware Configuration Change, Document Number: 337986-001), si vous n'effectuez pas un Clear CMOS, le BIOS appliquera les paramètres de l'ancien CPU au nouveau CPU, ce qui peut entraîner des problèmes de performance ou des échecs de démarrage. Par conséquent, Cincoze effectue une procédure de Clear CMOS avant l'expédition. Lorsque les clients mettent le système sous tension pour la première fois, il faudra plusieurs minutes pour démarrer. Cela est normal. Pendant ce processus, le système effectuera trois fois le POST et la LED d'alimentation alternera entre les lumières verte et bleue.)

Step 1. Locate the CPU socket.

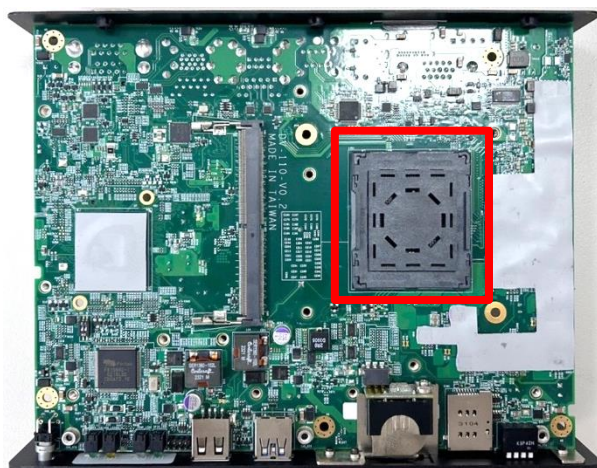

Step 2. Hold both sides of the cover of the CPU socket and remove it.

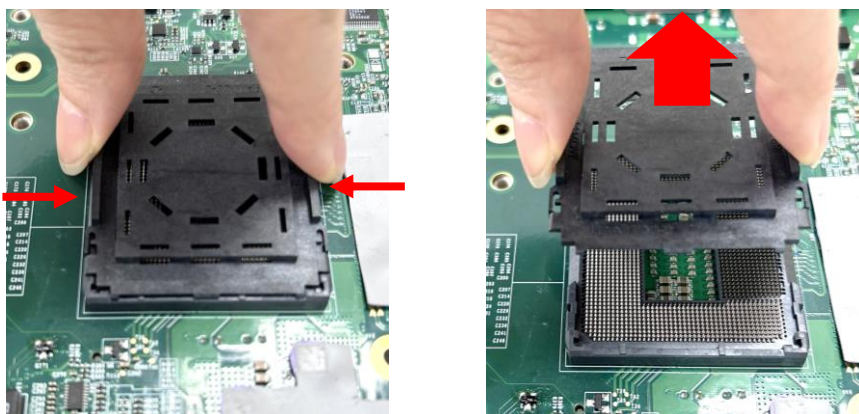

Step 3. Insert the CPU gently by aligning the notches of the socket.



Step 4. Place the CPU Bracket and secure it with the two indicated screws (M3x6, attached in the Screw Pack). This bracket requires a total of four screws to lock it completely. For the remaining two screws installation, refer to the "Installing Top Cover" Chapter.



Step 5. Make sure that the CPU surface is clean, and apply the thermal paste (attached in the CPU Installation Kit) onto the CPU's surface as shown below. For more detailed information about the thermal paste application, please find the [Intel official website](#).

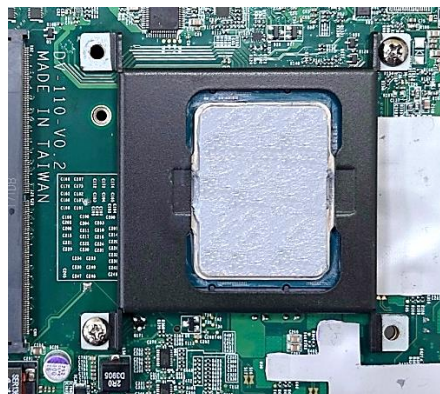

3.4 Installing SO-DIMM

Step 1. Locate the SO-DIMM socket on the top side of system.

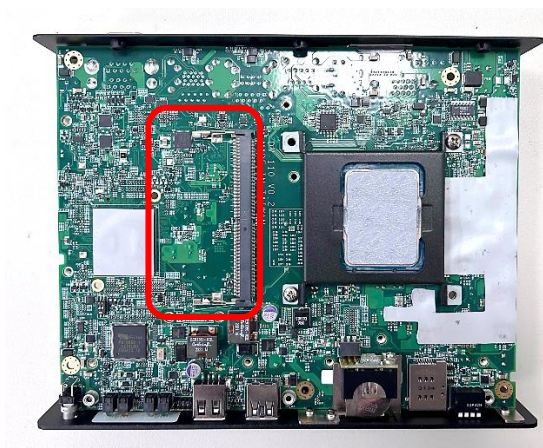

Step 2. Align the SO-DIMM notch with the socket notch. Insert it at a 45-degree angle until the edge connector is securely connected to the SO-DIMM socket.

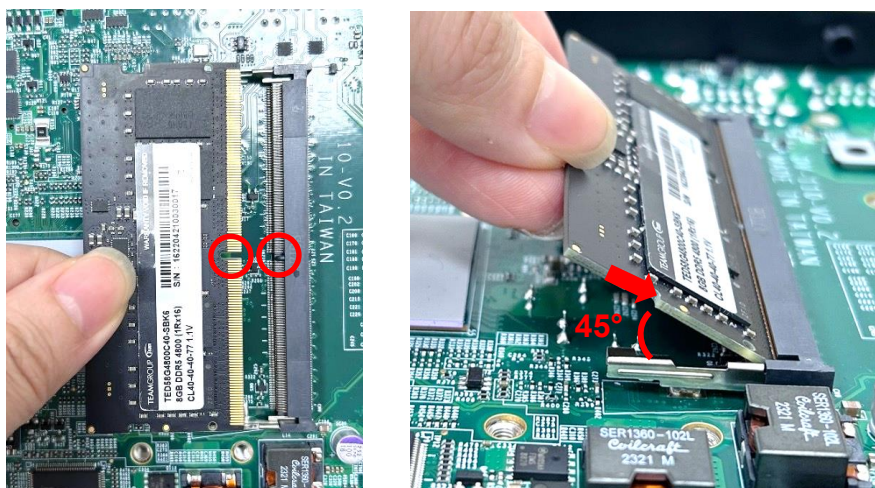

Step 3. Press down the module until the retaining clips snap back in place.



3.5 Installing Top Cover

If your CPU, SODIMM, and Antenna have been confirmed to be properly installed, please follow the steps in this section to reinstall the system body into the Top Cover. If, for any reason, you need to reinstall the CPU, SODIMM, or Antenna, you must start by removing the Top Cover according to the instructions in Chapter 3.1 to install the device.

Step 1. Hold the system body and reattach it to the top cover.

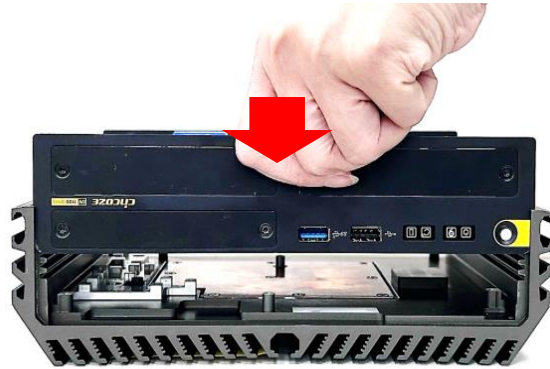

Step 2. Fasten the six red-indicated screws (M3x6) and the orange-indicated screw (M3x8, removed from Chapter 3.1).

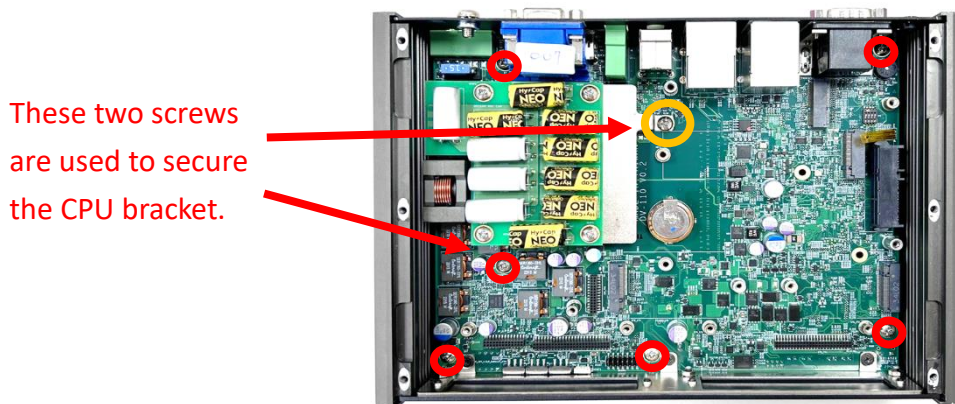

3.6 Installing 2.5" SATA HDD/SSD

Step 1. Locate the 2.5" SATA HDD/SSD socket.

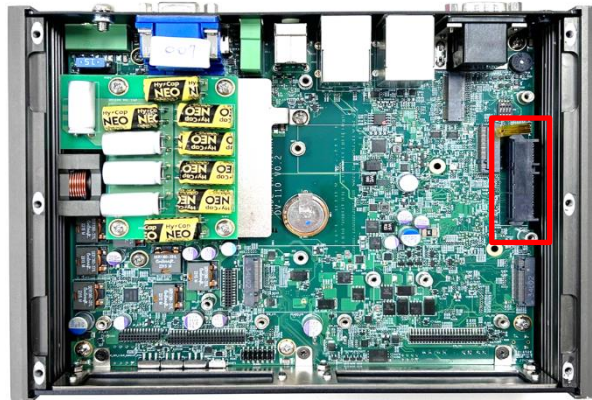

Step 2. Make the 2.5" SATA HDD/SSD bottom side face up, then place the HDD bracket on it. (removed from Chapter 3.1) Ensure the bracket is oriented correctly as indicated below, and use the 4 provided screws (M3x4, attached in the Screw Pack) to securely attach them together.

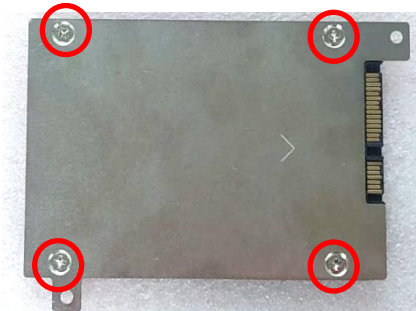

Step 3. Insert the HDD bracket and push it until the HDD connector fully engages with the SATA slot.



Step 4. Fix the HDD bracket by fastening the two screws (M3x4, removed from Chapter 3.1).



3.7 Installing M.2 Key M Module

Please note that the M.2 Key M module must be installed before the 2.5" SATA HDD/SSD due to the mechanical design.

Step 1. Locate the M.2 M Key M connector (CN13) on the system motherboard.

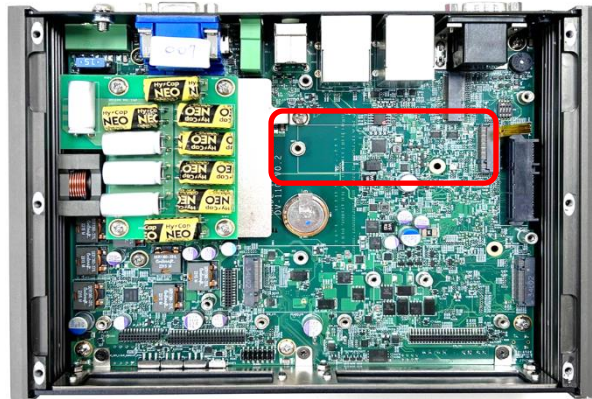

Step 2. Tilt the M.2 Key M module at a 45-degree angle and insert it to the socket until the golden finger connector of the card seated firmly.



Step 3. Press the module down and secure it with the screw (M3X5, attached in the Screw Pack).



3.8 Installing M.2 Key B Module

3.8.1 M.2 Key B type 3052

Step 1. Locate the M.2 Key B type 3052 connector (CN11) on the system motherboard.

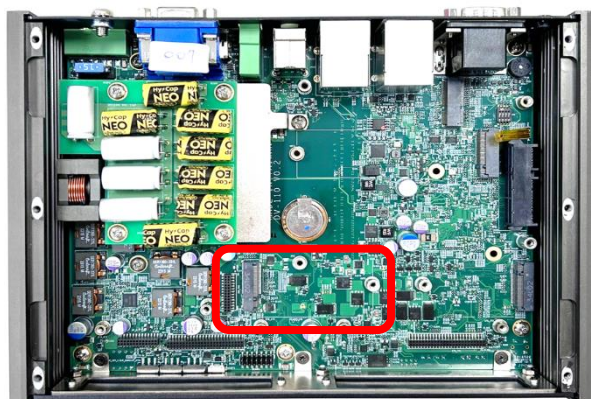

Step 2. Insert the M.2 Key B type 3052 module at a 45-degree angle and insert it to the slot until the gold-pated connector of module contacted firmly with the slot.



Step 3. Press down the module and fasten the screw to secure the module. (M3X5, attached in the Screw Pack).



3.8.2 M.2 Key B type 3042

Step 1. Locate the M.2 Key B type 3052 connector (CN11) on the system motherboard.

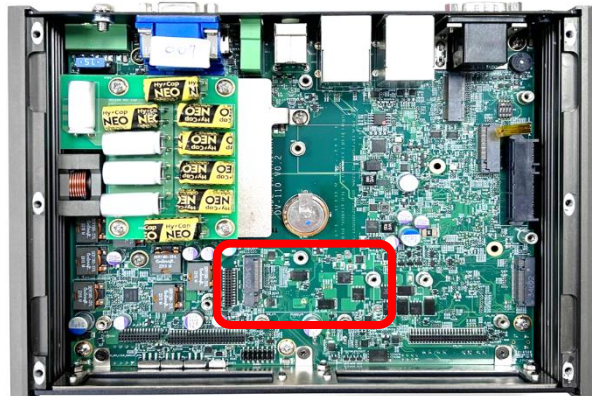

Step 2. Align the M.2 Key B Type 3052 to 3042 Adapter Bracket (attached in the Package) with the corresponding screw hole. Secure the bracket in place and fasten the screw (M3x4, attached in the Screw Pack).



Step 3. Insert the M.2 Key B module at a 45-degree angle and insert it to the slot until the gold-pated connector of module contacted firmly with the slot.



Step 4. Press down the module and fasten the screw to secure the module. (M3X5, attached in the Screw Pack).



3.8.3 M.2 Key B type 2242

Step 1. Locate the M.2 Key B type 2242 connector (CN12) on the system motherboard.

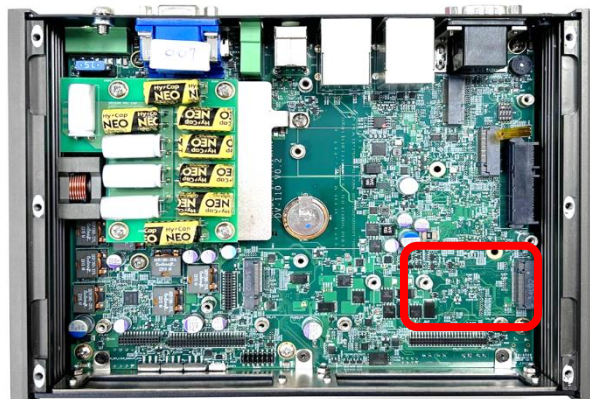

Step 2. Insert the M.2 Key B type 2242 module at a 45-degree angle and insert it to the slot until the gold-pated connector of module contacted firmly with the slot.



Step 4. Press down the module and fasten the screw to secure the module.



3.9 Installing M.2 Key E Module

Step 1. Locate the M.2 Key E connector (CN8) on the system motherboard.

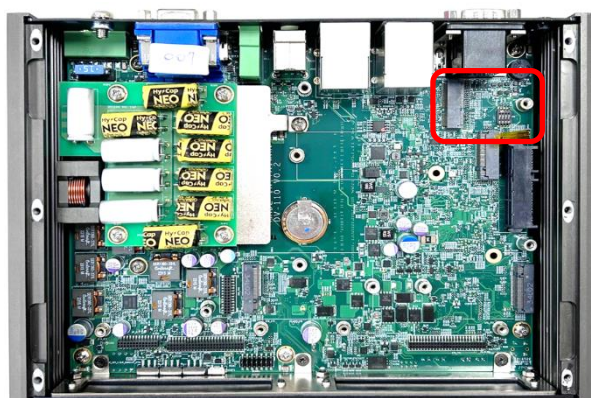

Step 2. Tilt the M.2 Key E module at a 45-degree angle and insert it to the socket until the golden finger connector of the card seated firmly.



Step 3. Press the module down and secure it with the screw (M3X5, attached in the Screw Pack).



3.10 Installing CMI Module

3.10.1 CMI-DP01-R10/UB1606-R10 Module

Step 1. Unscrew the 2 screws to remove bracket from front panel.



Step 2. Locate the DP_B1 connector.

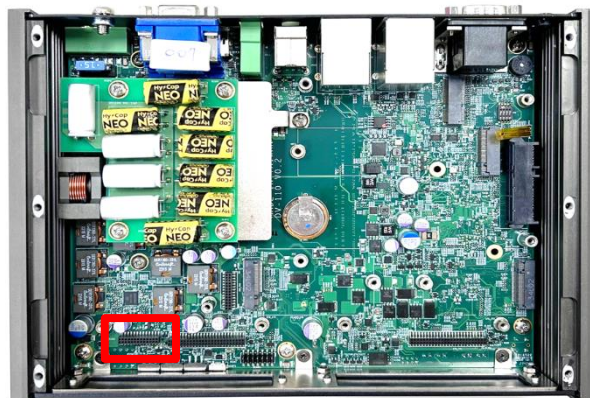

Step 3. Fasten the two copper pillar screws as indicated. When fixing the copper pillars (attached in the CMI module pack), please be careful not to lock them too tightly so as not to damage the boss. It is recommended to use a 4kgf torque wrench to tighten the copper pillars.

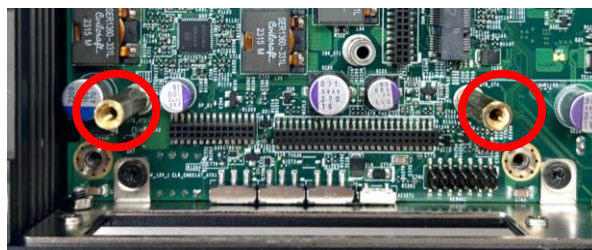

Step 4. Insert the module vertically to the connector, and then fasten the 2 screws to fix it.

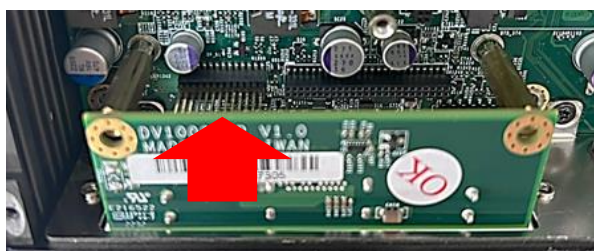

Step 5. Attach on the CMI-DP01 bracket, and fasten the screws as indicated.



Please ensure the [Graphics Configuration](#) in the BIOS is set appropriately for successful display from this module.

3.10.2 CMI-HD03-R10/UB1608-R10 Module

Step 1. Unscrew the 2 screws to remove bracket from front panel.



Step 2. Locate the DP_B1 connector.

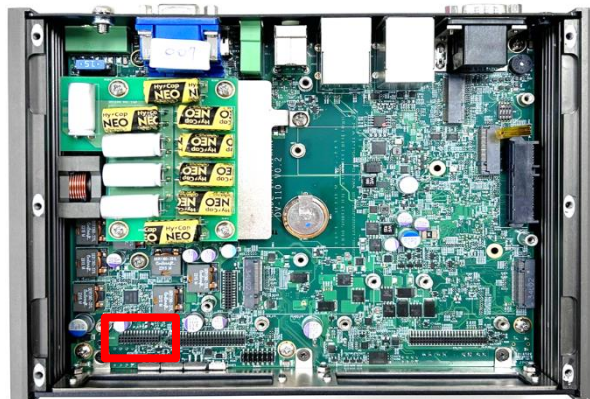

Step 3. Fasten the two copper pillar screws as indicated. When fixing the copper pillars (attached in the CMI module pack), please be careful not to lock them too tightly so as not to damage the boss. It is recommended to use a 4kgf torque wrench to tighten the copper pillars.



Step 4. Insert the module vertically to the connector, and then fasten the 2 screws to fix it.

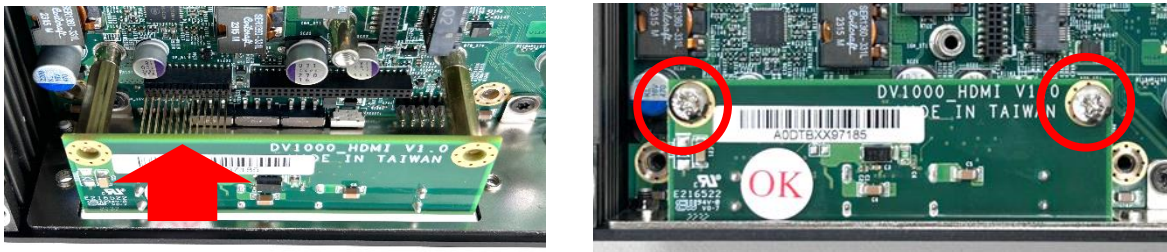

Step 5. Attach on the CMI-HD03 bracket, and fasten the screws as indicated.



Please ensure the [Graphics Configuration](#) in the BIOS is set appropriately for successful display from this module.

3.10.3 CMI-COM06-R10/UB1603-R10

For pin definitions related to this module, please refer to Chapter 2.5.1.

Step 1. Loosen the 2 screws on the bracket 1 or 2 at the front bezel and then remove the cover plate.

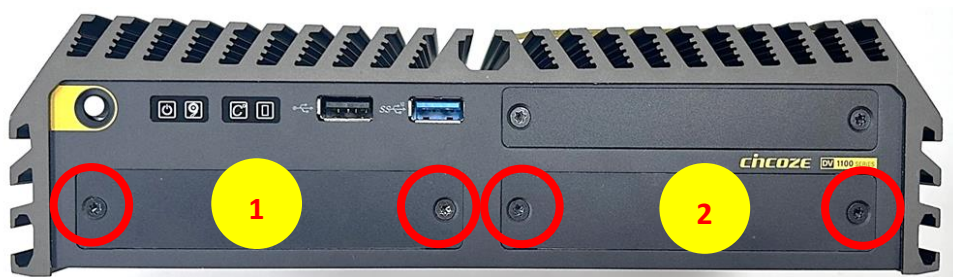

Step 2. Locate the BTB_FH1 or BTB_FH2 connector.

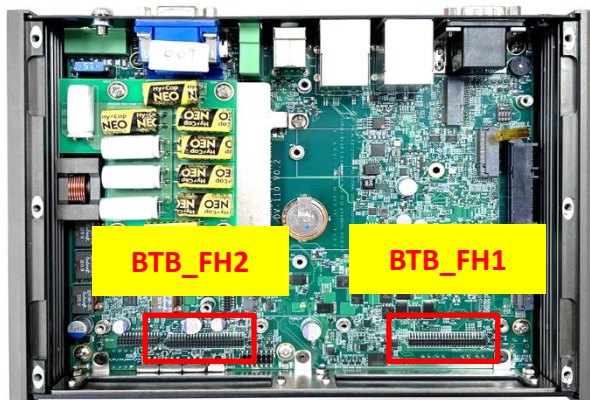

Step 3. Fasten the two copper pillar screws as indicated. When fixing the copper pillars (attached in the CMI module pack), please be careful not to lock them too tightly so as not to damage the boss. It is recommended to use a 4kgf torque wrench to tighten the copper pillars.



Step 4. Insert the module vertically to the connector, and then fasten the 2 screws to fix it.

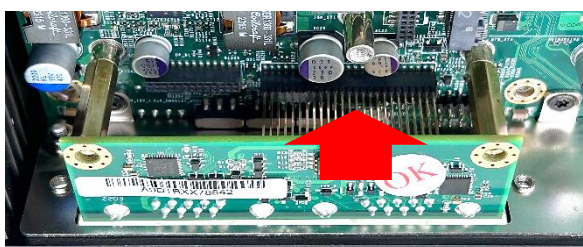

Step 5. Attach on the CMI-COM06 bracket, and fasten the screws as indicated.



3.10.4 CMI-DIO06-R10/UB1618-R20

For pin definitions related to this module, please refer to Chapter 2.5.2.

Step 1. Loosen the 2 screws on the bracket 1 or 2 at the front bezel and then remove the cover plate.



Step 2. Locate the BTB_FH1 or BTB_FH2 connector.

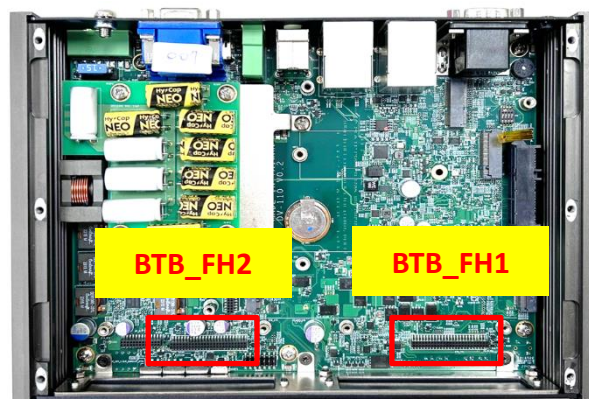

Step 3. Attach on the CMI-DIO06 bracket. Fasten the 2 screws to fix it.



Step 4. Insert the module vertically to the connector and fix it with the 2 screws.



Step 5. Upon completion, the module installation will appear as below.



3.11 Installing CFM Module

For pin definitions related to this module, please refer to Chapter 2.3 (SW3 and 24V_12V_1).

3.11.1 CFM-IGN04-R10

Step 1. Locate the IGN_PH1 connector.

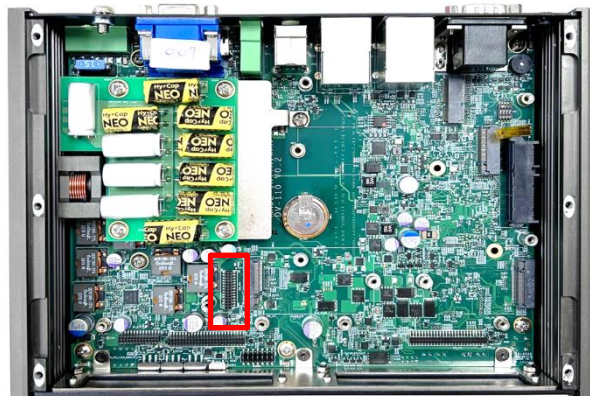

Step 2. Insert the module vertically to the connector



Step 3. fasten the screw to fix it.



3.12 Installing Bottom Cover

Step 1. Place the bottom cover (removed from Chapter 3.1) back to system and fasten it with the 6 screws.



3.13 Removing Maintenance Area Panel

Step 1. Loosen the 2 screws on the Maintenance Area Panel and remove it.



3.14 Installing SIM Card

Please refer to Chapter 3.8 to install a 5G/4G module before the SIM card installation for the SIM application.

Step 1. Locate the SIM card slot at front side.



Step 2. Push the SIM card adapter to pull it out.



Step 3. When pulling out the SIM card adapter, you will find there are two SIM card slots on the adapter. The top side is SIM1 slot, and the bottom side is SIM2 slot.



Top Side: SIM1



Bottom Side: SIM2

Step 4. Install SIM card(s) into the SIM card adapter. In this installation example, we install a SIM card into the SIM1 Slot.



Step 5. Insert the SIM card adapter as shown below. Our SIM card slot and adapter have foolproof mechanism to guide you to install the SIM card correctly; it will not fit if inserted incorrectly. And please note when both SIM cards are installed, the network connection will prioritize the card at SIM1.

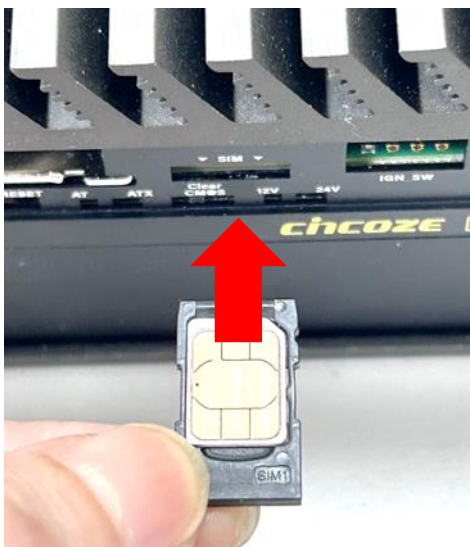

3.15 Replacing CMOS Battery

This chapter introduces the process of replacing the CMOS battery when it has depleted.

Step 1. Locate the position of removable CMOS Battery.



Step 2. Loosen the screw as indicated.



Step 3. Pull out the CMOS battery bracket.



Step 4. Loosen the screw as indicated.

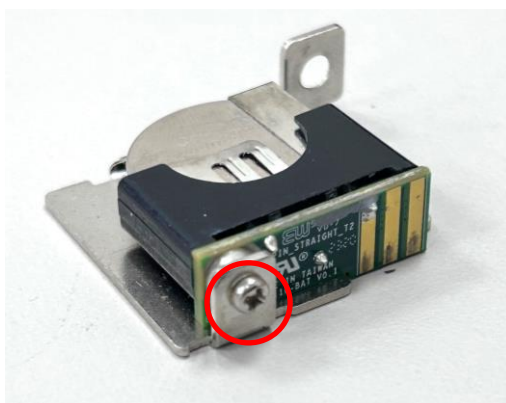

Step 5. Pull down the indicated portion and replace the CMOS battery with a new one. (please note the battery's positive/negative pole orientation when you execute this step).

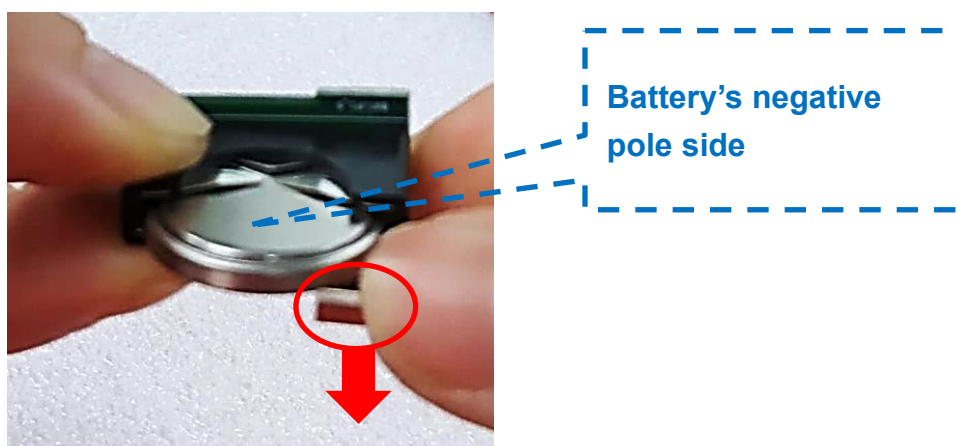

Step 6. Fasten the screw back.



Step 7. Insert the CMOS battery bracket.



Step 8. Fasten the screw back.



3.16 Installing Maintenance Area Panel

Step 1. Fasten the screws as indicated to install the Maintenance Area Panel back to the system.



3.17 Installing Wall Mount

This system offers wall mount brackets for customers to install system on the wall in a convenient and economical way.



Step 1. The mounting holes are at the bottom side of system. Use provided 8 screws (M3x5L) to fasten the bracket on each side.

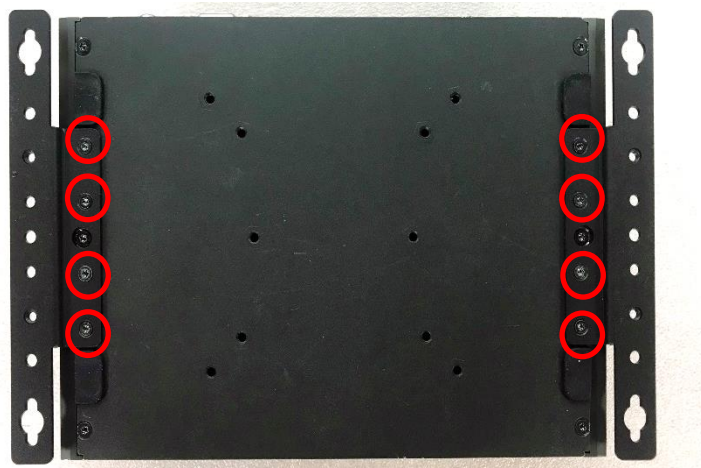

Step 2. Then user can fix the system onto the wall by fastening 2 mounting holes on each side of the wall mount bracket on the wall.



3.18 Installing VESA Mount

The following picture indicates VESA mounting holes on the DV-1100 series, which is compliant with VESA mounting standard. The blue holes correspond to the 75x75mm VESA mounting standard, and the red holes correspond to the 100x100mm VESA mounting standard.

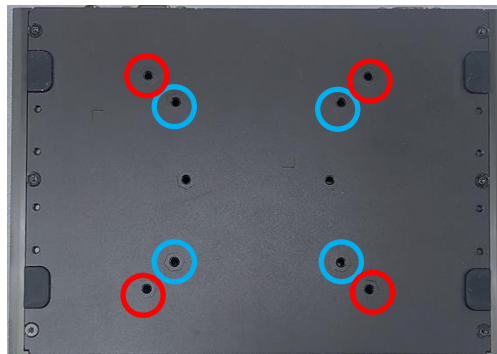

Step 1. Align the stand with the screw holes on the system, then secure it in place by tightening the corresponding number of screws as shown below. (Please note the VESA mounting holes deep 3 mm at the back of the terminal are provided with 4 x M4-type blind fasteners to fix the VESA mounting plate. A different screw length (L) should be selected.)

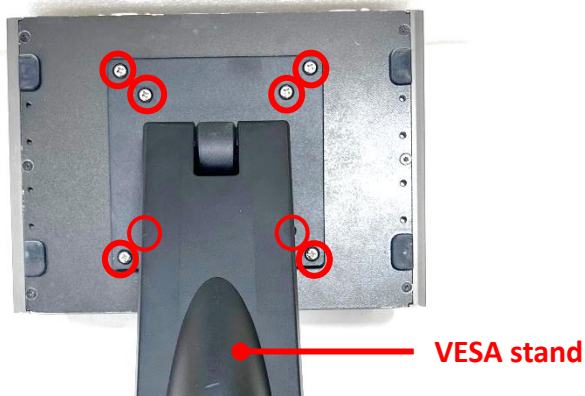

Step 2. Then, the VESA mount installation is complete.



3.19 Installing DIN-Rail Mount

The DV-1100 series offers an optional accessory for DIN-Rail mounting, DIN-RAIL Mount Kit (Model No. DINRAIL-R10) as shown below. If you have acquired this accessory, please refer to the installation instructions hereafter.



Step 1. Locate the two mounting holes for DIN-rail mounting on the bottom of system, and then fasten the 2 screws (with each screw size of P4x5L) to fix the DIN-Rail mounting bracket with the system together.

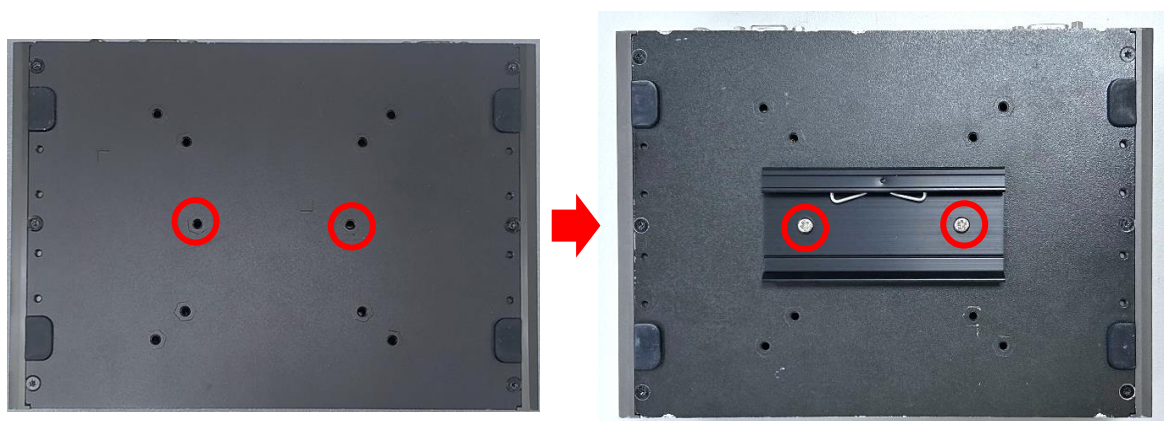

Step 2. Then user can clip the system into DIN rail through the DIN-RAIL Mount Kit.



3.20 Installing External FAN

The DV-1100 series offers an optional accessory of the External FAN (Model No. FAN-EX104) as shown in step 1. If you have acquired this accessory, please refer to the installation instructions hereafter.

Step 1: Locate the two screws on the mounting frame.



Step 2: Loosen two screws without removing them.

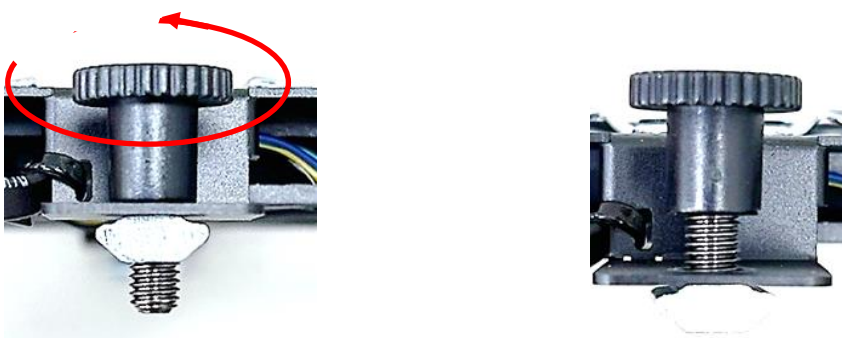

Step 3: Align the two screws and slide the fan into the middle groove of the chassis until it reaches the center position (the both screws will be in the groove at the same time).

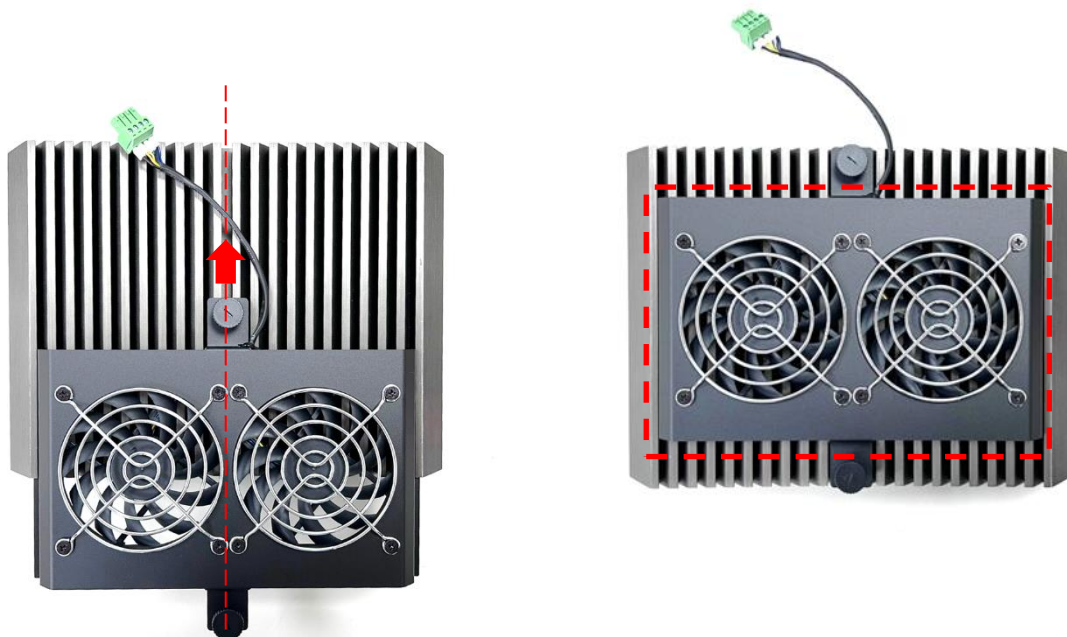

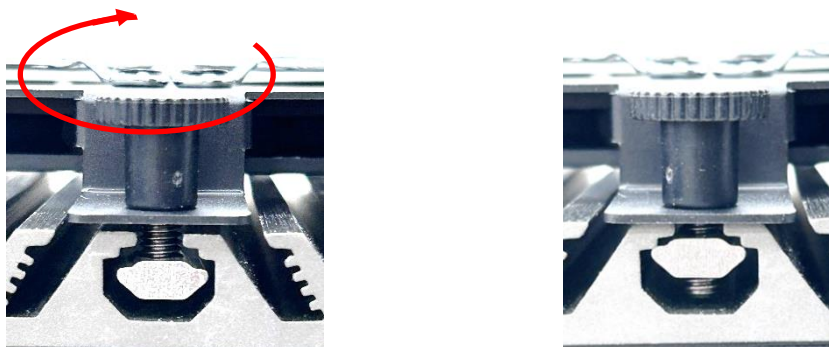

Step 4. Tighten the two screws.



Step 5. Connect the FAN cable to external fan power connector firmly on the rear panel of the system.





Chapter 4

BIOS Setup

4.1 BIOS Introduction

The BIOS (Basic Input/ Output System) is a program located on a Flash Memory on the motherboard. When you start the computer, the BIOS program will gain control. The BIOS first operates an auto-diagnostic test called POST (power on self-test) for all the necessary hardware, it detects the entire hardware device and configures the parameters of the hardware synchronization.

BIOS Setup

Power on the computer and by pressing immediately allows you to enter Setup. If the message disappears before your respond and you still wish to enter Setup, restart the system to try again by turning it OFF then ON or pressing <Ctrl>, <Alt> and <Delete> keys.

Control Keys	
<←> <→>	Move to select screen
<↑> <↓>	Move to select item
<Esc>	Quit the BIOS Setup
<Enter>	Select item
<Page Up/+>	Increases the numeric value or makes changes
<Page Down/->	Decreases the numeric value or makes changes
<Tab>	Select setup fields
<F1>	General help
<F2>	Previous value
<F3>	Load Optimized defaults
<F10>	Save configuration and Exit

Main Menu

The main menu lists the setup functions you can make changes to. You can use the arrow keys (↑↓) to select the item. The on-line description of the highlighted setup function is displayed at the bottom of the screen.

Sub-Menu

If you find a right pointer symbol appears to the left of certain fields that means a sub-menu can be launched from this field. A sub-menu contains additional options for a field parameter. You can use arrow keys (↑↓) to highlight the field and press <Enter> to call up the sub-menu. Then you can use the control keys to enter values and move from field to field within a sub-menu. If you want to return to the main menu, just press the <Esc >.

4.2 Main Setup

Press to enter BIOS CMOS Setup Utility, the Main Menu (as shown below) will appear on the screen. Use arrow keys to move among the items and press <Enter> to accept or enter a sub-menu.

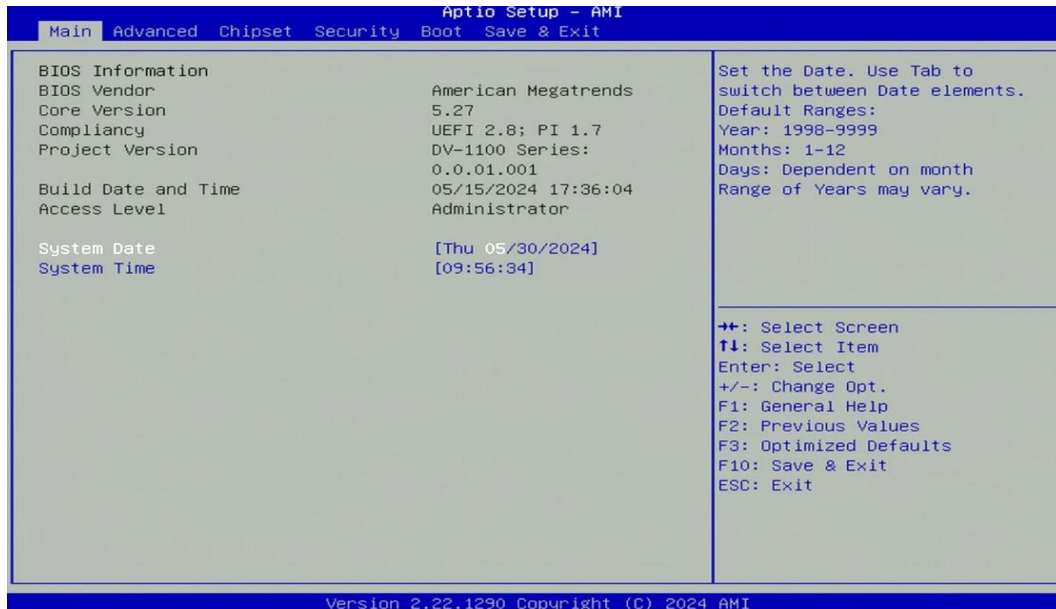

■ System Date

Set the date. Please use <Tab> to switch between date elements.

■ System Time

Set the time. Please use <Tab> to switch between time elements.

4.3 Advanced Setup

This section allows you to configure and improve your system and allows you to set up some system features according to your preference.

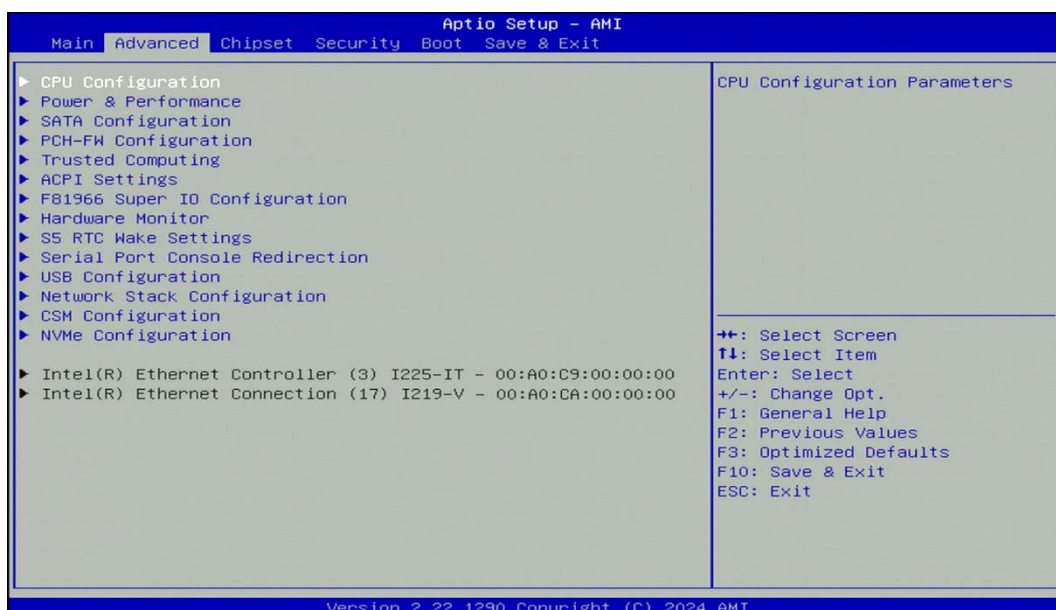

4.3.1 CPU Configuration

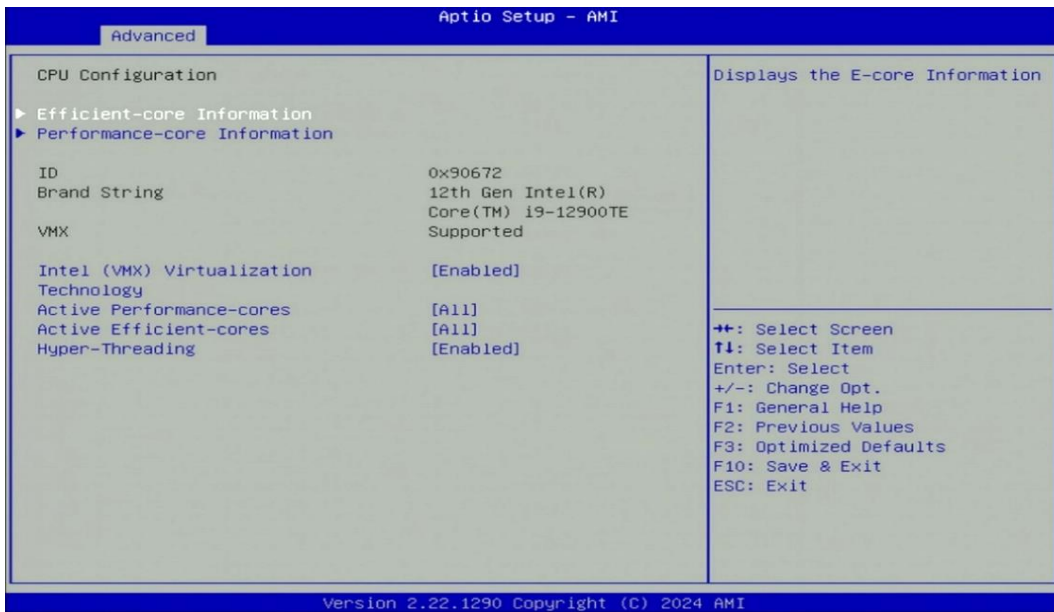

■ Efficient-core Information

This page displays the E-core Information.

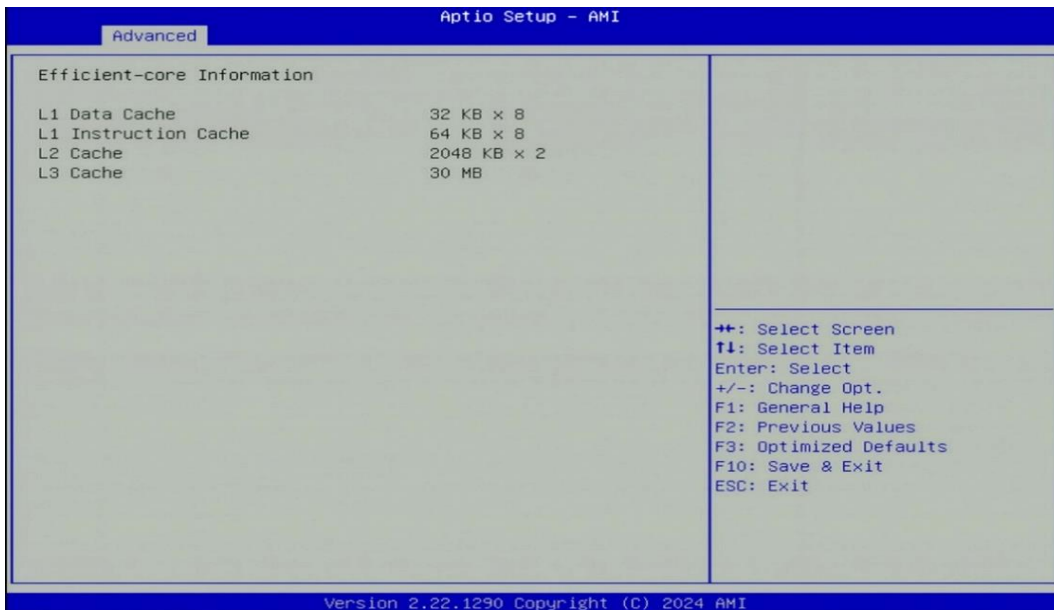

■ Performance-core Information

This page displays the P-core Information.

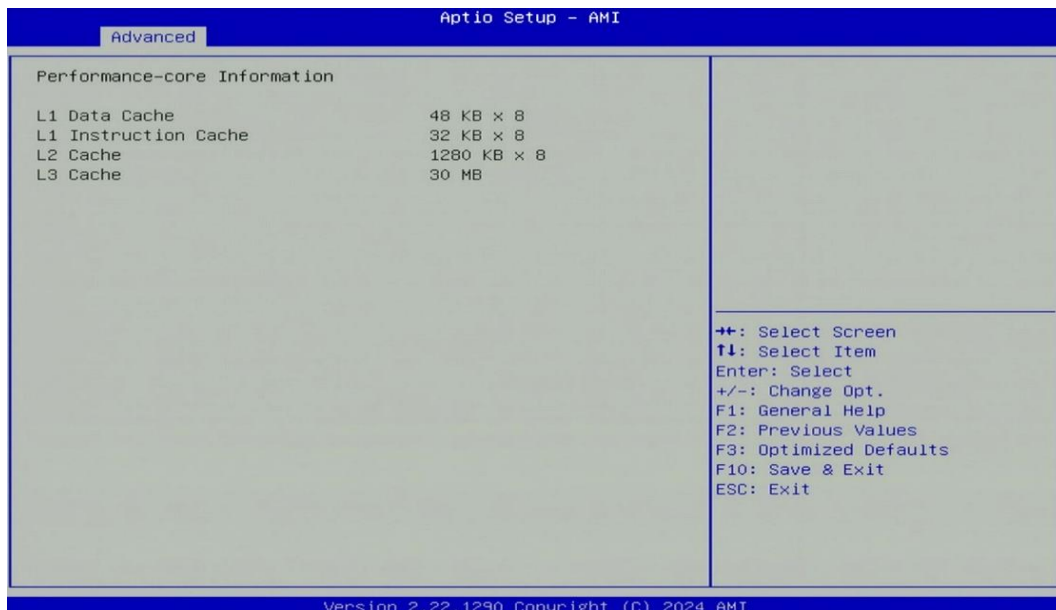

■ **Intel (VMX) Virtualization Technology [Enabled]**

Enables or disables Intel Virtualization Technology. Virtualization enhanced by Intel Virtualization Technology will allow a platform to run multiple operating systems and applications in independent partitions. With virtualization, one computer system can function as multiple virtual systems.

■ **Active Performance-cores**

Allows you to choose the number of active performance cores.

Configuration options: [All] [7] [6] [5] [4] [3] [2] [1].

■ **Active Efficient-cores**

Allows you to choose the number of active efficient cores.

Configuration options: [All] [7] [6] [5] [4] [3] [2] [1] [0].

■ **Hyper-threading**

Enables or disables for Hyper-Threading Technology.

4.3.2 Power & Performance

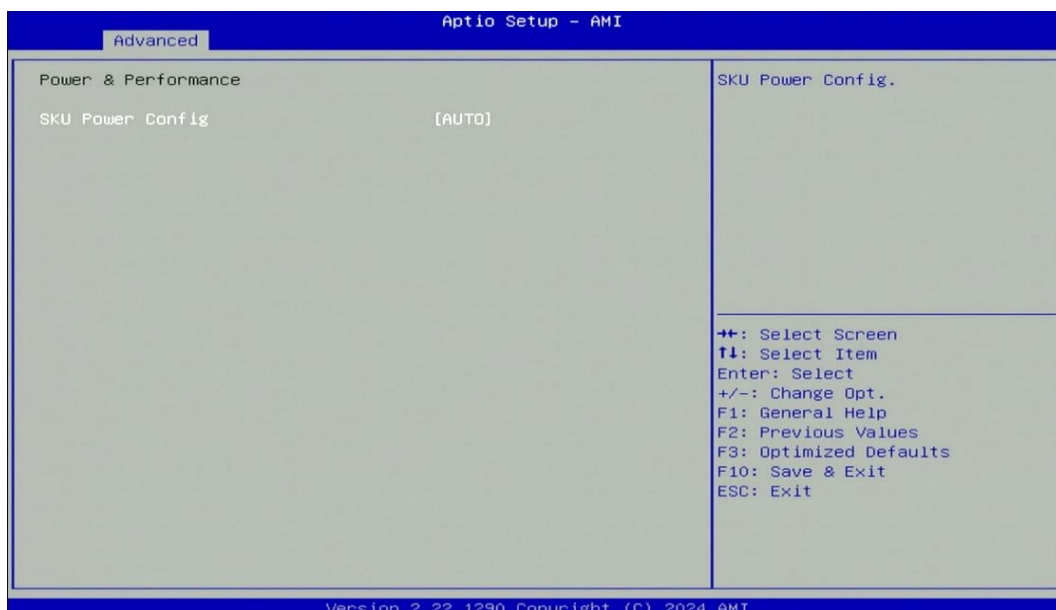

■ SKU Power Config [Auto]

Allows users to choose the upper limit of CPU power.

Configuration options: [Auto] [35W]

4.3.3 SATA Configuration

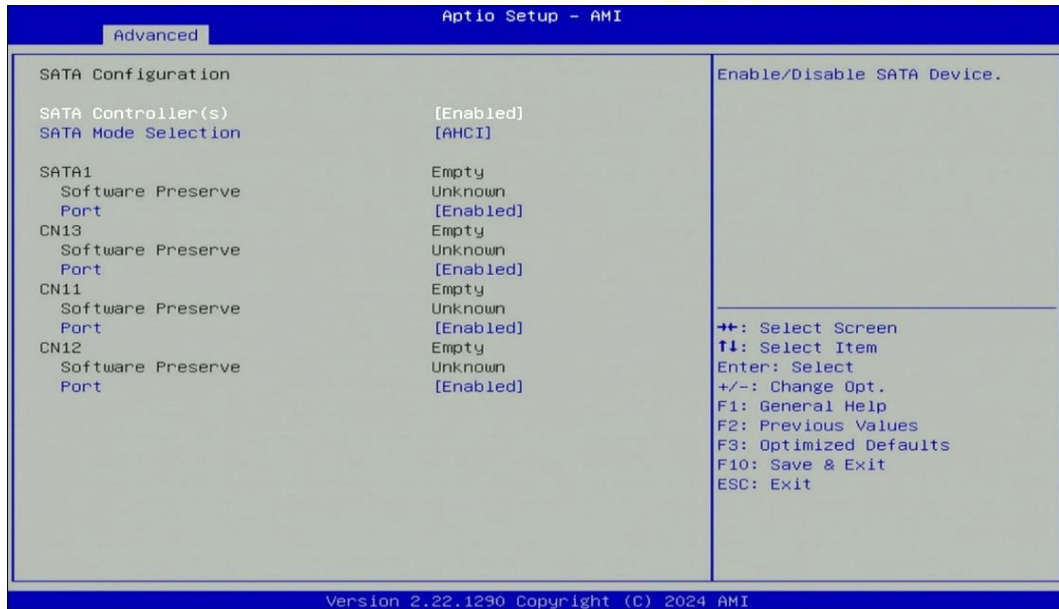

■ SATA Controller(s) [Enabled]

Enables or disables SATA device.

■ SATA Mode Selection [AHCI]

Allows you to select which mode SATA controller will operate.

Configuration options: [AHCI]

■ SATA 1

Port [Enabled]

Enables or disables SATA 1.

■ CN13

Port [Enabled]

Enables or disables CN13.

■ CN11

Port [Enabled]

Enables or disables CN11.

■ CN12

Port [Enabled]

Enables or disables CN12.

4.3.4 PCH-FW Configuration

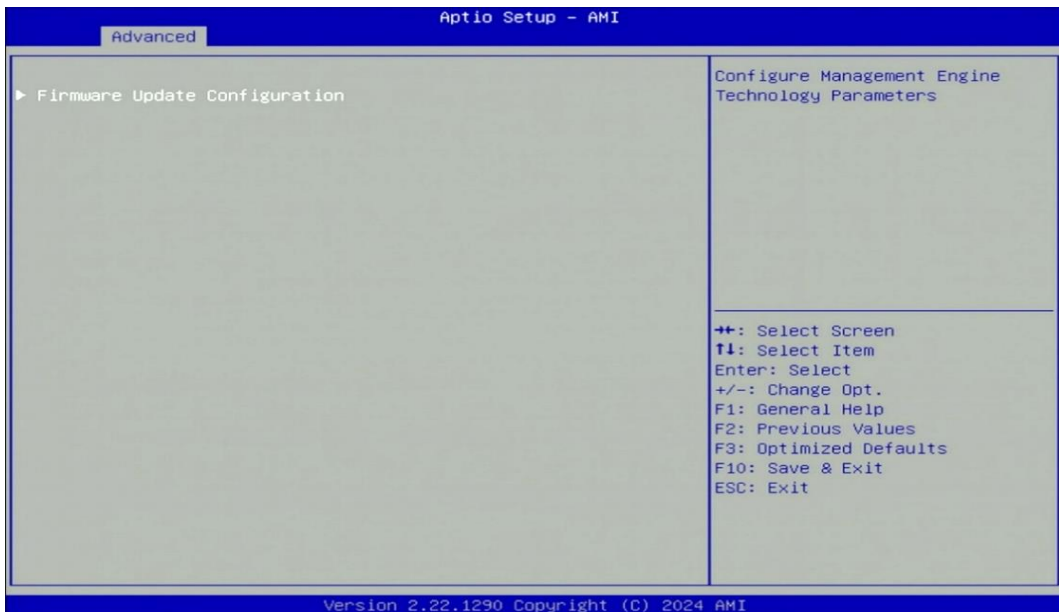

■ Firmware Update Configuration

Configure Management Engine Parameters



■ Me FW Image Re-Flash [Disabled]

Enables or disables ME firmware Image Re-Flash function.

4.3.5 Trusted Computing Settings

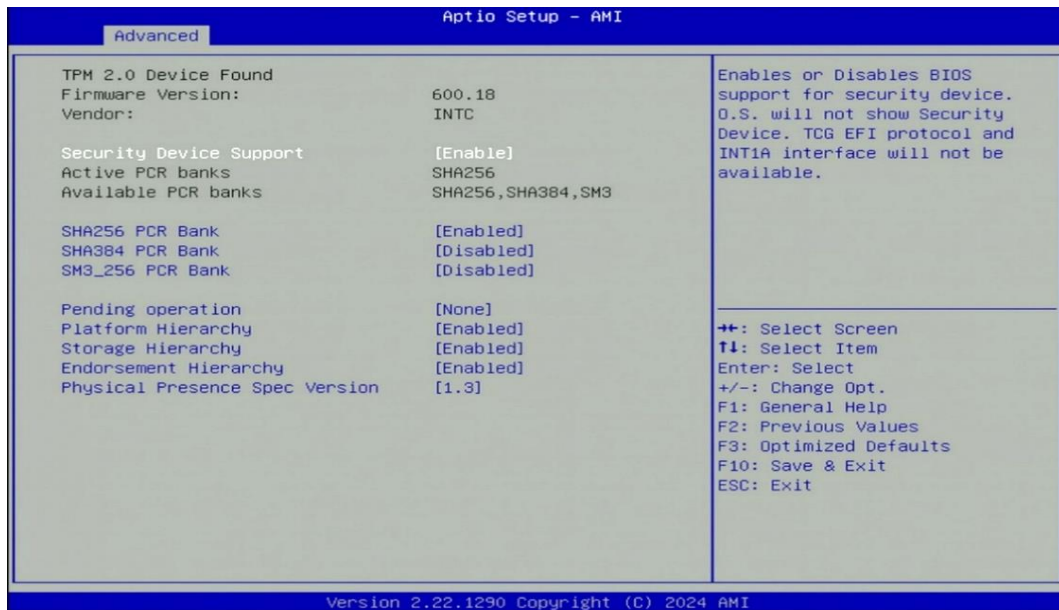

■ Security Device Support [Enabled]

Enables or disables Security Device Support function.

■ SHA256 PCR Bank [Enabled]

Enables or disables SHA256 PCR Bank function.

■ SHA384 PCR Bank [Disabled]

Enables or disables SHA384 PCR Bank function.

■ SM3_256 PCR Bank [Disabled]

Enables or disables SM3_256 PCR Bank function.

■ Pending Operation [None]

Allows you to select which mode Pending Operation will operate.

Configuration options: [None], [TPM Clear]

■ Platform Hierarchy [Enabled]

Enables or disables Platform Hierarchy function.

■ Storage Hierarchy [Enabled]

Enables or disables Storage Hierarchy function.

■ Endorsement Hierarchy [Enabled]

Enables or disables Endorsement Hierarchy function.

■ Physical Presence Spec Version [1.3]

Allows you to select which mode Physical Presence Spec Version will operate.

Configuration options: [1.2], [1.3]

4.3.6 ACPI Settings

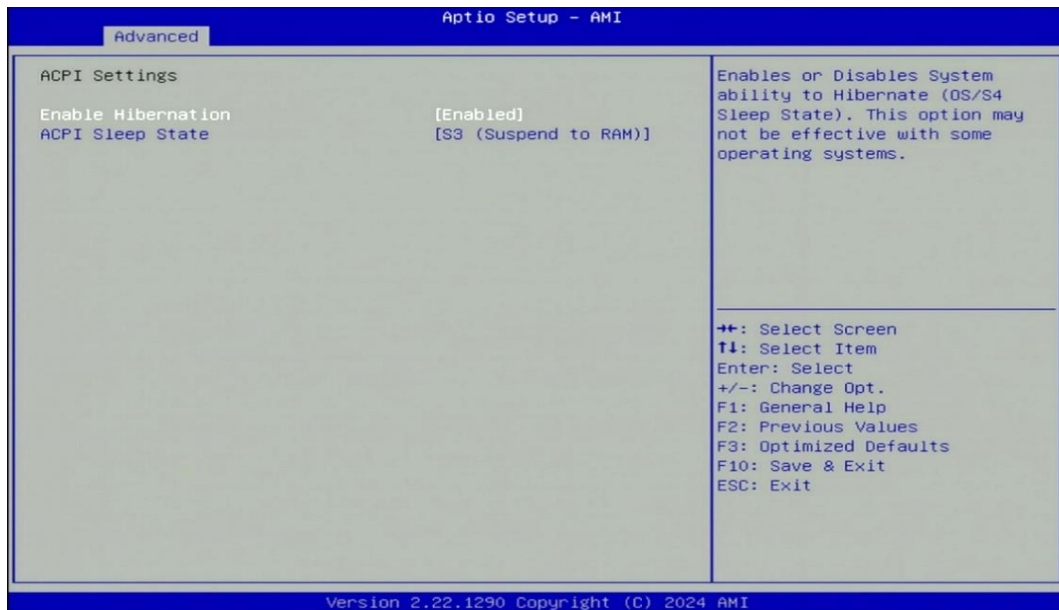

■ Enable Hibernation [Enabled]

Enables or disables system ability to hibernate state (OS/S4 state). This option may not be effective with some OS.

■ ACPI Sleep State [S3 (Suspend to RAM)]

Allows users to select the highest Advanced Configuration Power Interface® (ACPI) sleep state that system will enter when suspend button is pressed.

[Suspend Disabled]: Disables entering suspend state.

[S3 (suspend to RAM)]: Enables suspend to RAM state.

4.3.7 F81966 Super IO Configuration

Set Parameters of Serial Ports. User can Enable/Disable the serial port and select an optimal setting for the Super IO Device.

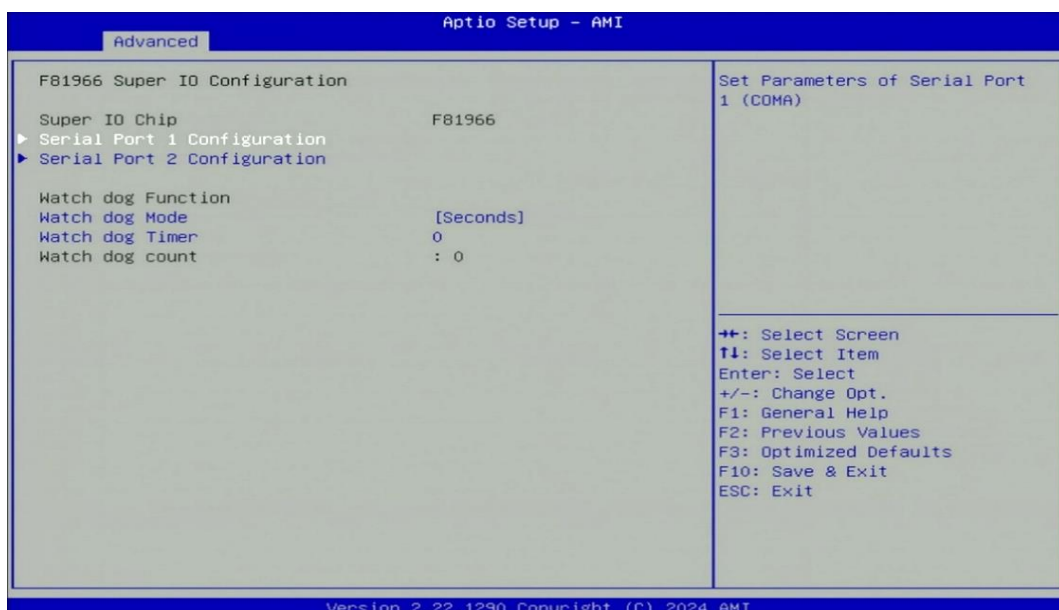

■ Serial Port 1 Configuration.

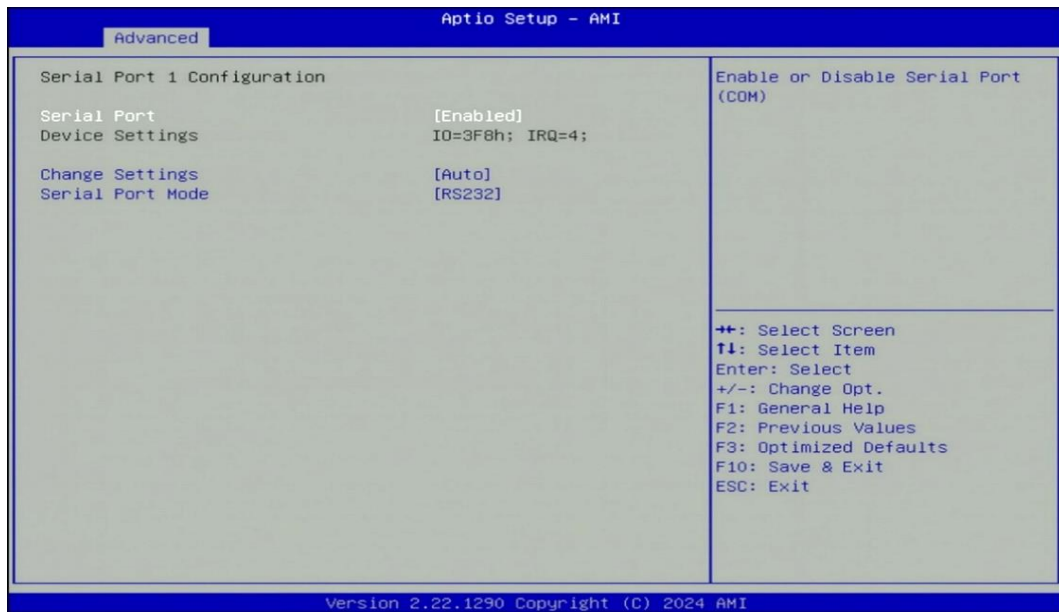

■ Serial Port [Enabled]

Enables or disables serial port.

■ Change Settings [Auto]

Allows you to change the IO Address & IRQ settings of the specified serial port.

■ Onboard Serial Port 1~2 Mode [RS232]

Allows you to select Serial Port Mode.

Configuration options: [RS232] [RS422/RS485 Full Duplex] [RS485 Half Duplex]

■ Watch Dog [Disabled]

Enables or disables watch dog function.

■ Watch Dog Mode [Sec]

Allows to set watchdog timer unit <Sec> or <Min>.

■ Watch Dog Timer [0]

Allows you to set watchdog timer's value in the range of 0 to 255.

4.3.8 Hardware Monitor

This screen displays the current status of all monitored hardware devices/components such as voltages, temperatures.

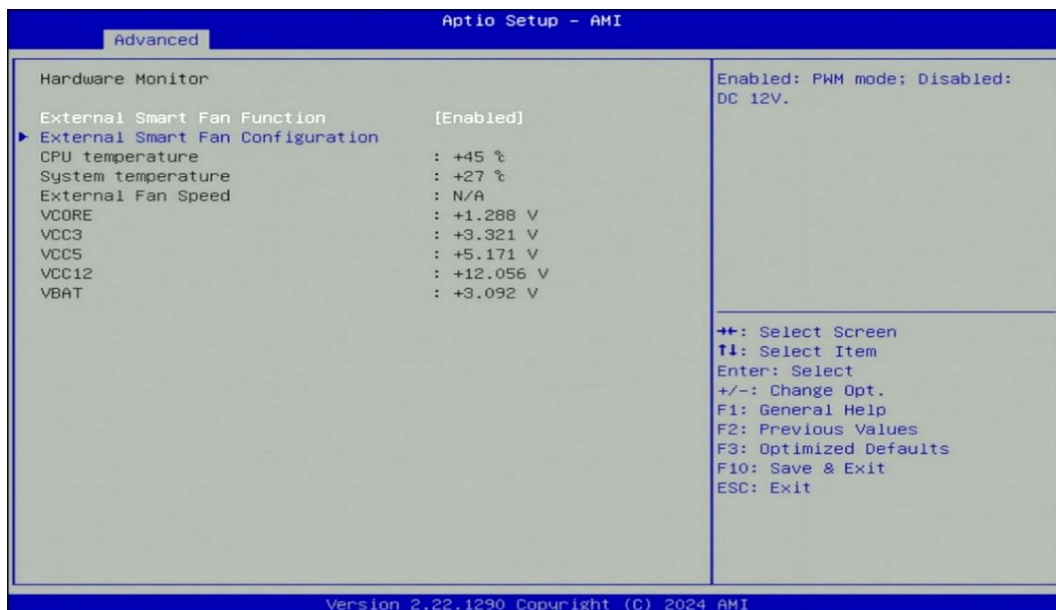

- **External Smart Fan Function [Enabled]**

Enables or disables External Smart Fan function.

- **External Smart Fan Configuration**

Configure External Smart Fan Parameters.

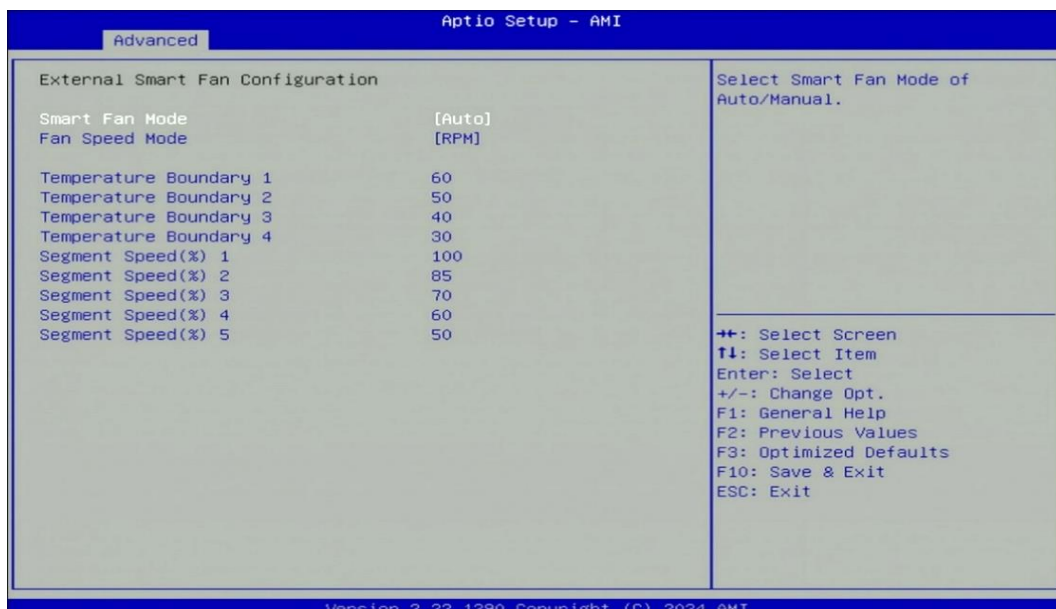

- **Smart Fan Mode [Auto]**

Allows you to select Smart Fan Mode.

Configuration options: [Auto] [Manual]

- **Fan Speed Mode [RPM]**

Allows you to select Fan Speed Mode.

Configuration options: [RPM] [Duty]

4.3.9 S5 RTC Wake Settings



■ Wake system from S5 [Disabled]

Enables or disables wake system from S5 (soft-off state).

[Disabled]: Disables wake system from S5.

[Fixed Time]: Sets a fixed time (HH:MM:SS) to wake system from S5.

[Dynamic Time]: Sets an increase minute(s) from current time to wake system from S5.

4.3.10 Serial Port Console Redirection

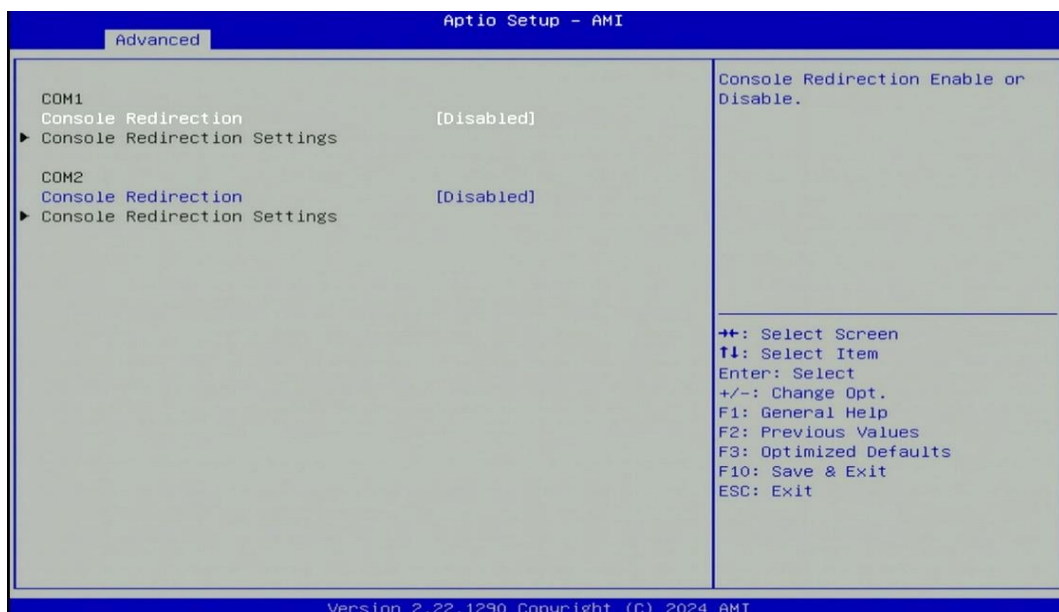

■ Console Redirection [Disabled]

Allow users to enable or disable COM1, COM2 console redirection function.

4.3.11 USB Configuration

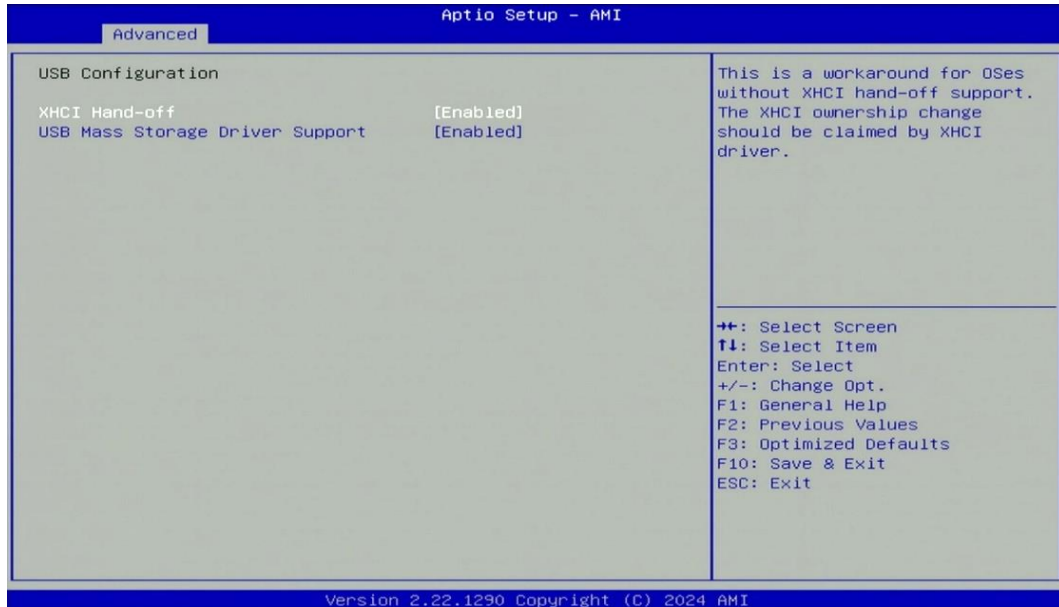

■ XHCI Hand-off [Enabled]

Enables or disables XHCI (USB3.0) hand-off function. Use this feature as a workaround for operating systems without XHCI hand-off support.

■ USB Mass Storage Driver Support [Enabled]

Enables or disables USB mass storage driver support.

4.3.12 Network Stack Configuration

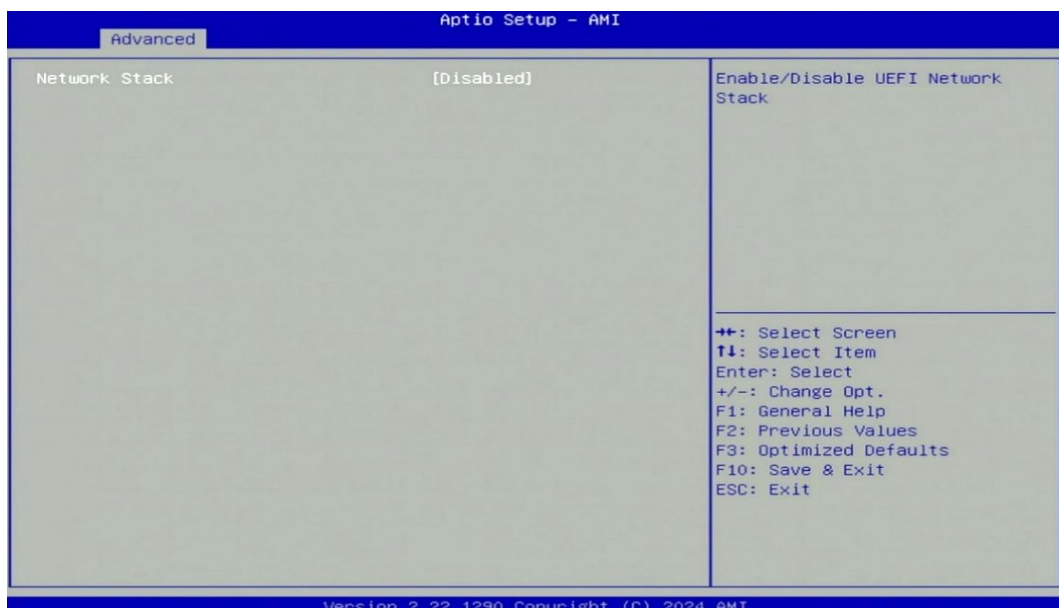

■ Network Stack [Disabled]

Enables or disables UEFI Network Stack.

4.3.13 CSM Configuration

This option controls legacy/UEFI ROMs priority.

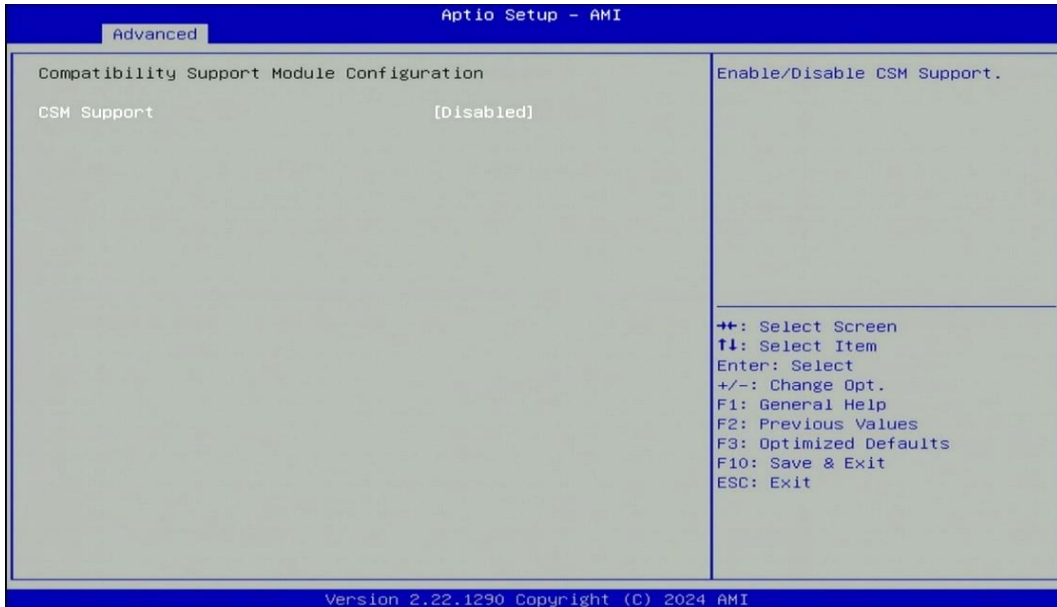

■ CSM Support [Disabled]

Enables or disables compatibility support module.

4.3.14 NVMe Configuration

The screen allows users to select options for the NVMe configuration, and change the value of the selected option. If there is NVMe Device detected, the options will show as the NVMe Device is found.

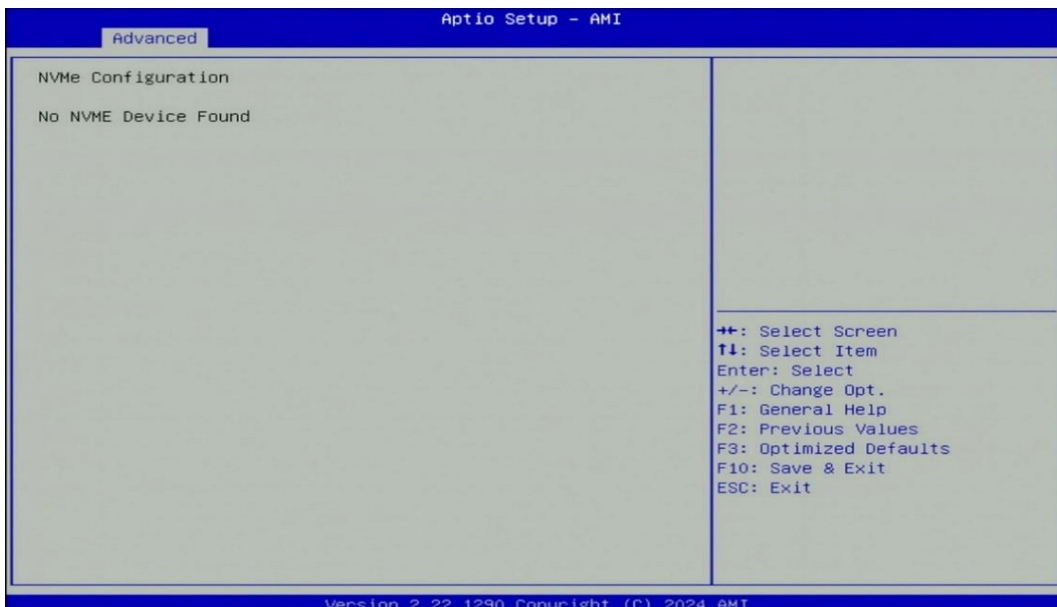

4.4 Chipset Setup

This section allows you to configure chipset related settings according to user's preference.

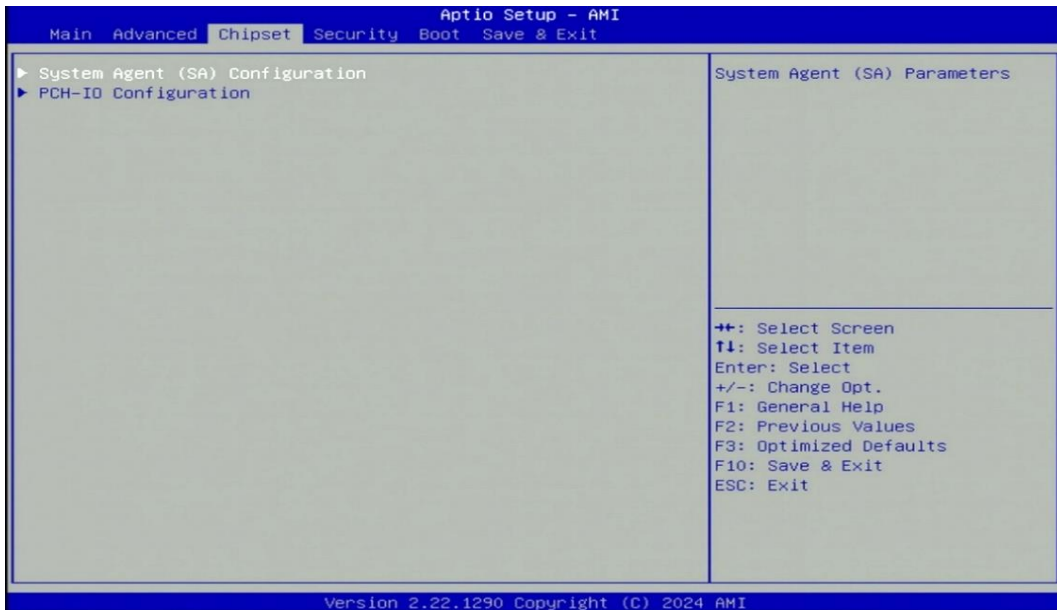

4.4.1 System Agent (SA) Configuration

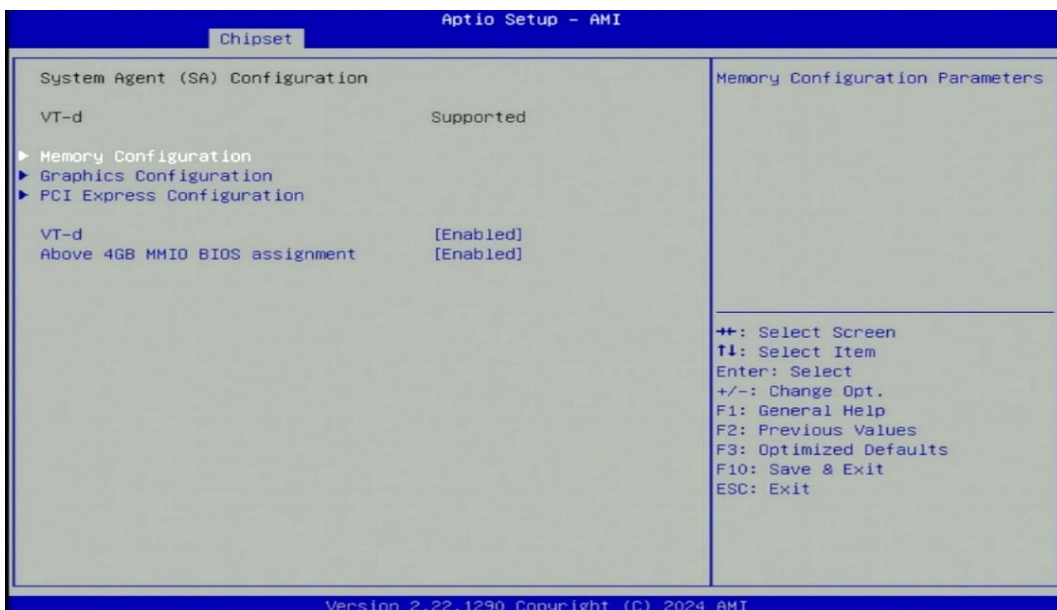

■ Memory Configuration

This item displays detailed memory configuration in the system.

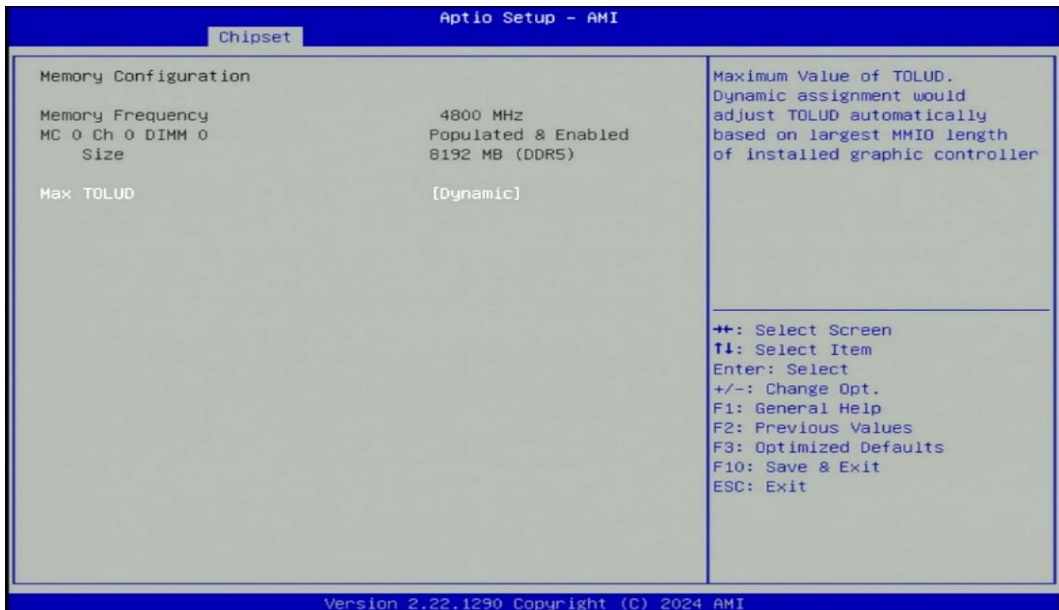

■ Graphics Configuration



■ CMI Module [DP/VGA]

This option enables users to choose the type of CMI Module. The default setting is DP. If the CMI-HDMI module is utilized, kindly ensure to configure this function as [HDMI] to ensure successful display from the CMI-HDMI module.

Configuration options: [DP] [HDMI]

■ PCI Express Configuration

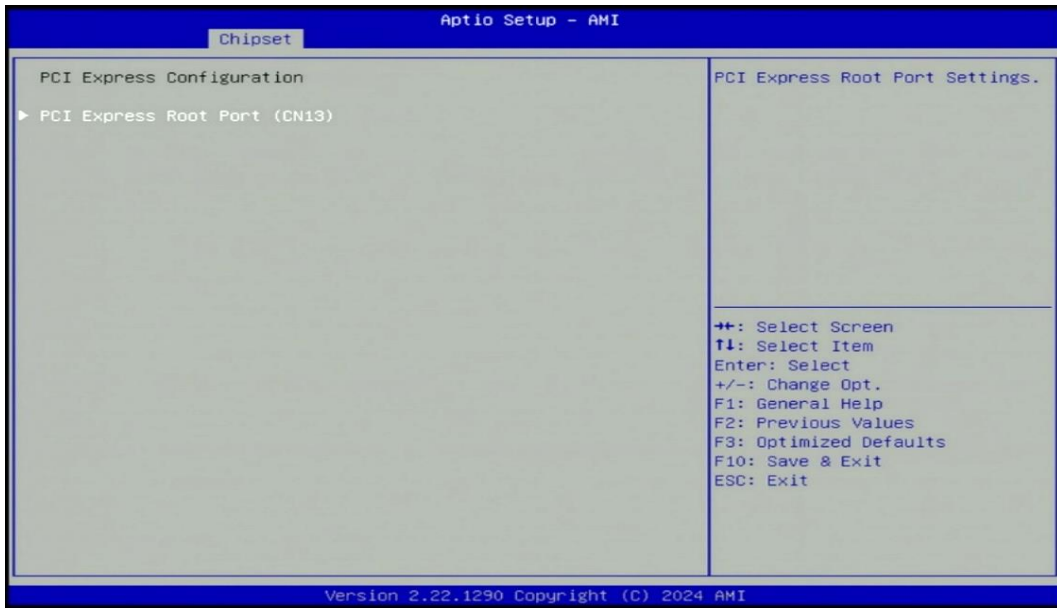

■ PCI Express Root Port (CN13)

■ PCI Express Root Port [Enabled]

Enables or disables PCI Express Root Port.

■ PCIe Speed [Auto]

Allows you to select PCI Express interface speed.

Configuration options: [Auto] [Gen1] [Gen2] [Gen3] [Gen4].

■ VT-d [Enabled]

Enables or disables Intel® Virtualization Technology for Directed I/O (VT-d) capability.

4.4.2 PCH-IO Configuration

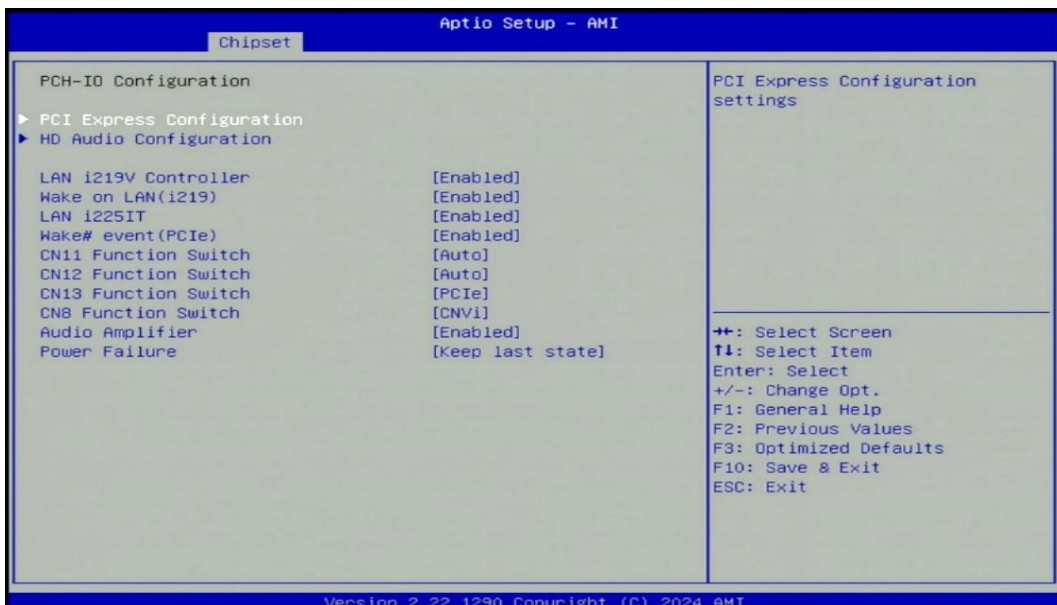

■ PCI Express Configuration

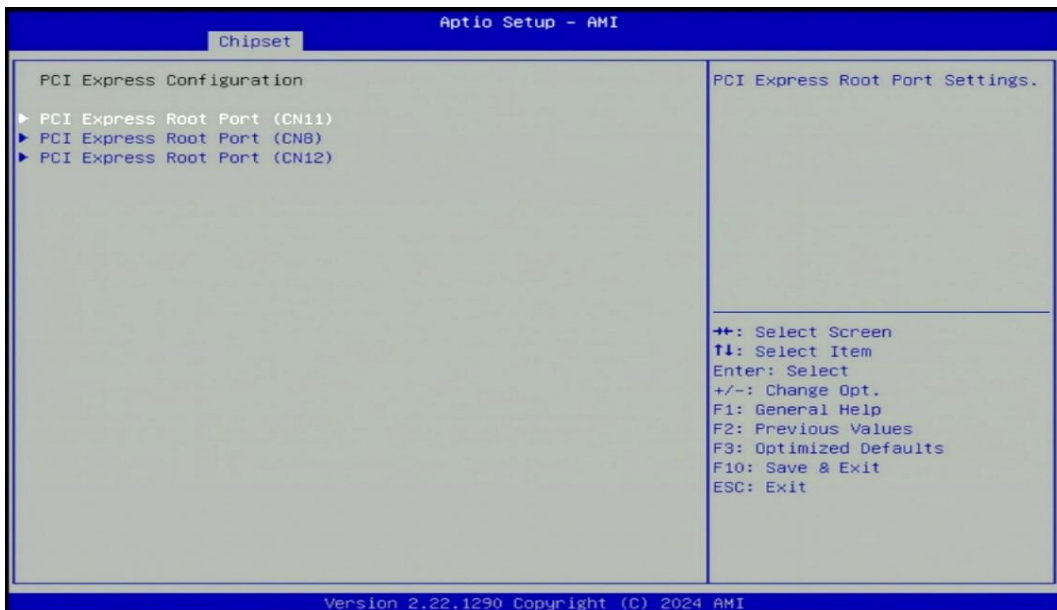

■ PCI Express Root Port (CN11)

■ PCI Express Root Port [Enabled]

Enables or disables PCI Express Root Port.

■ PCIe Speed [Auto]

Allows you to select PCI Express interface speed.

Configuration options: [Auto] [Gen1] [Gen2] [Gen3].

■ PCI Express Root Port (CN8)

■ PCI Express Root Port [Enabled]

Enables or disables PCI Express Root Port.

■ PCIe Speed [Auto]

Allows you to select PCI Express interface speed.

Configuration options: [Auto] [Gen1] [Gen2] [Gen3].

■ PCI Express Root Port (CN12)

■ PCI Express Root Port [Enabled]

Enables or disables PCI Express Root Port.

■ PCIe Speed [Auto]

Allows you to select PCI Express interface speed.

Configuration options: [Auto] [Gen1] [Gen2] [Gen3].

■ HD Audio Configuration

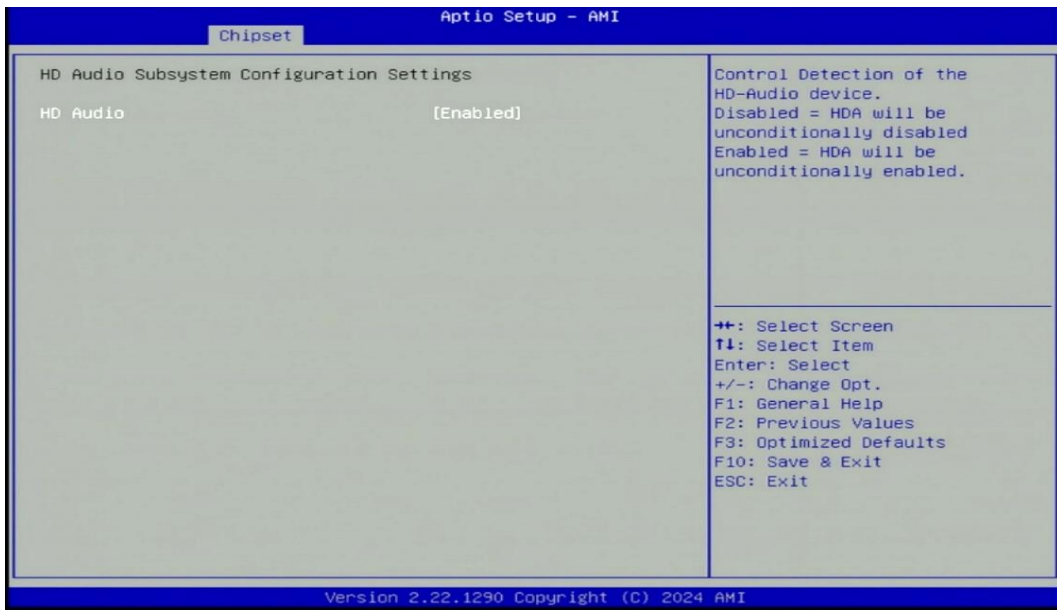

■ HD Audio [Enabled]

Enables or disables HD Audio.

■ LAN i219V Controller [Enabled]

Enables or disables I219 LAN Controller.

■ Wake on LAN (i219) [Enabled]

Enables or disables integrated LAN Wake on LAN function.

■ LAN i225IT [Enabled]

Enables or disables I225 LAN Controller.

■ Wake# event (PCIe) [Enabled]

Enables or disables Wake# event (PCIe).

■ CN11 Function Switch [Auto]

Allows you to change CN11 Function as [Auto], [SSD-SATA], [SSD-PCIe], [WWAN-PCIe], or [WWAN-USB3].

■ CN12 Function Switch [Auto]

Allows you to change CN12 Function as [Auto], [SSD-SATA], [SSD-PCIe].

■ CN13 Function Switch [PCIe]

Allows you to change CN13 Function as [PCIe] or [SATA].

■ CN8 Function Switch [CNVi]

Allows you to change CN8 Function as [CNVi] or [Wifi].

■ Audio Amplifier [Enabled]

Enables or disables Audio Amplifier Function.

■ Power Failure [Keep last state]

Allows you to specify which power state system will enter when power is resumed after a power failure (G3 state).

[Always on]: Enters to power on state.

[Always off]: Enters to power off state.

[Keep last state]: Enters to the last power state before a power failure.

4.5 Security Setup

This section allows users to configure BIOS security settings.

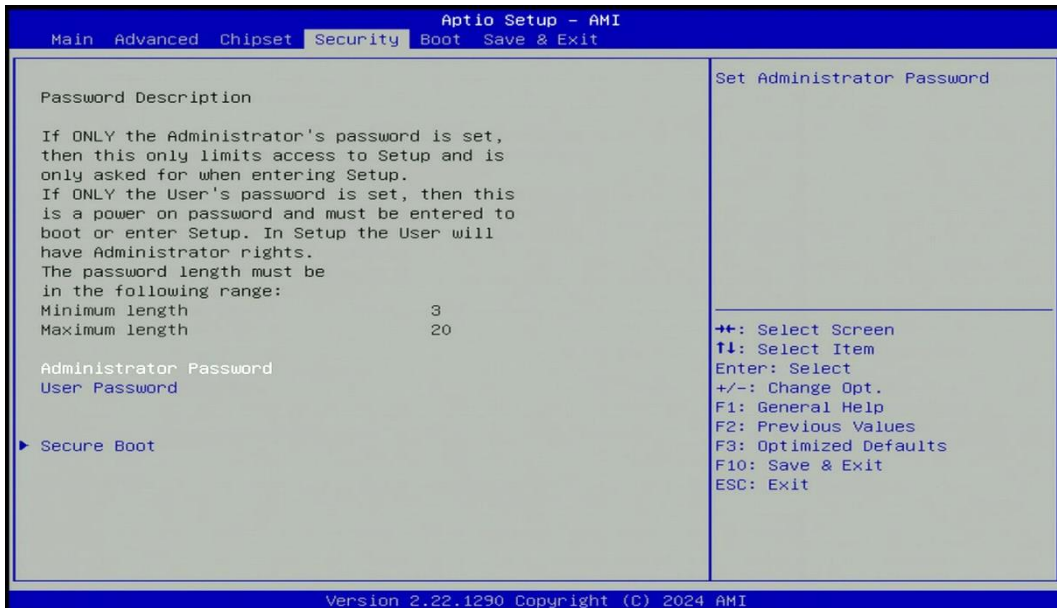

■ Administrator Password

Administrator Password controls access to the BIOS Setup utility.

■ User Password

User Password controls access to the system at boot and to the BIOS Setup utility.

■ Security Boot

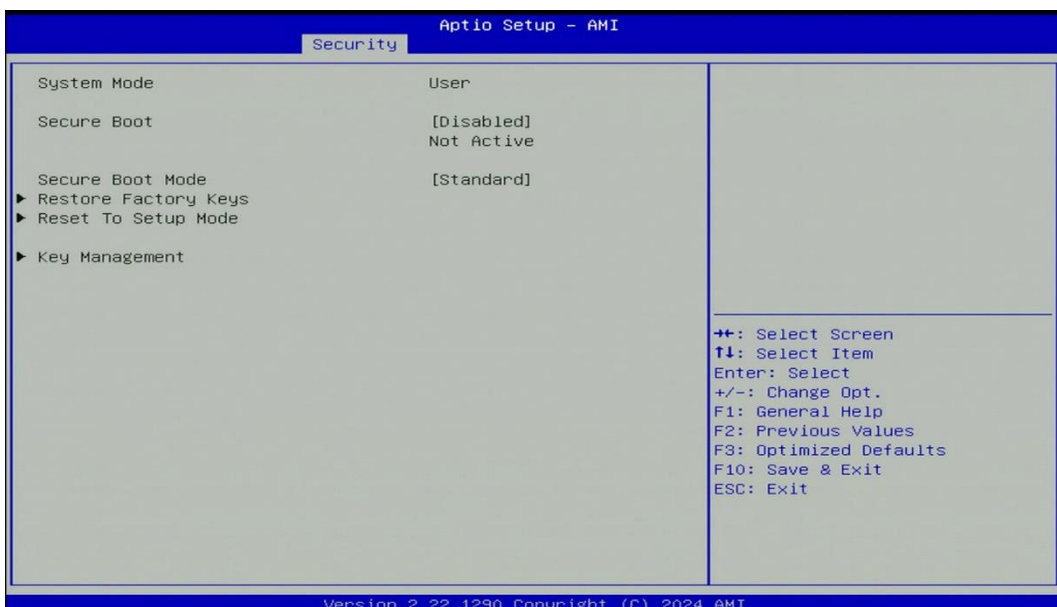

4.6 Boot Setup

This section allows you to configure Boot settings.

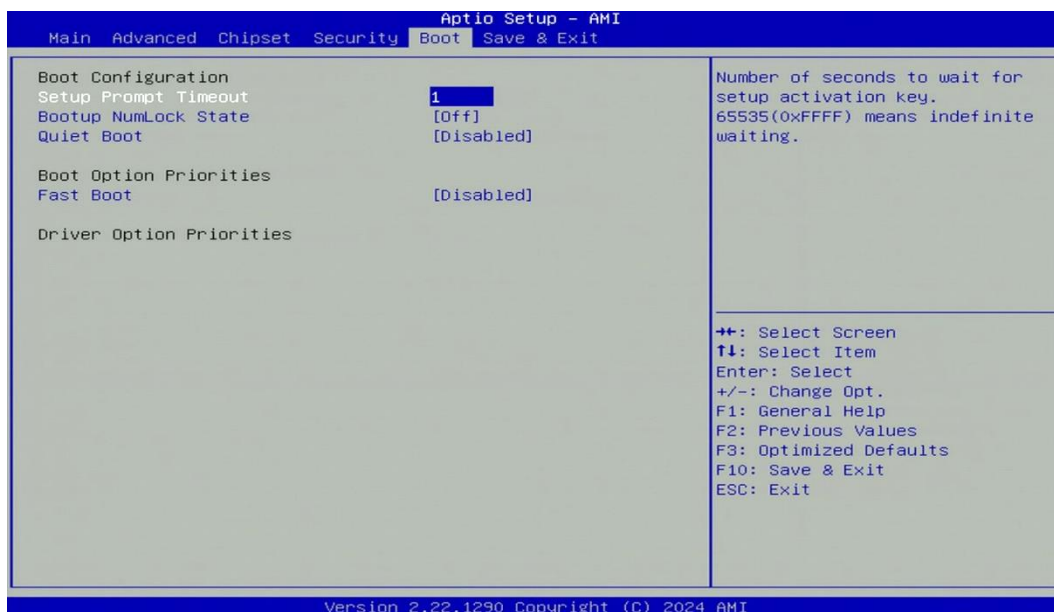

■ Setup Prompt Timeout [1]

Use this item to set number of seconds (1..65535) to wait for setup activation key.

■ Bootup NumLock State [Off]

Allows you to set NumLock key to [On] or [Off] state when system boots up.

■ Quiet Boot [Disabled]

Allows you to enable or disable Quiet Boot function.

■ Fast Boot [Disabled]

Allows you to enable or disable Fast Boot function. If enabled, system boots with initialization of a minimal set of devices required to launch active boot option.

4.7 Save & Exit

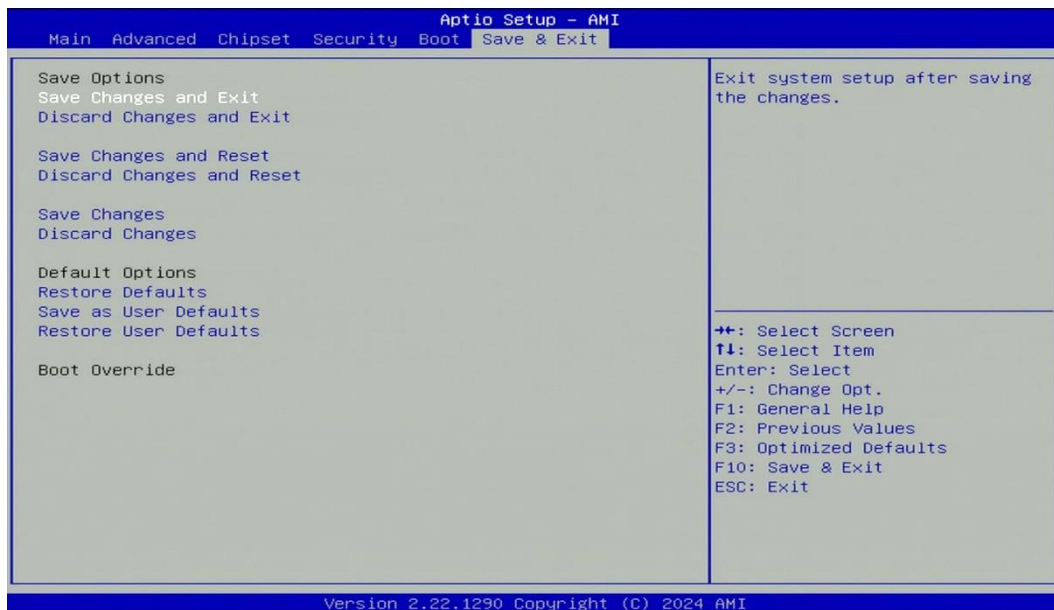

■ Save Changes and Exit

This item allows you to exit the system after saving changes.

■ Discard Changes and Exit

This item allows you to exit system setup without saving any changes.

■ Save Changes and Reset

This item allows you to reset the system after saving changes.

■ Discard Changes and Reset

This item allows you to reset system setup without saving any changes.

■ Save Changes

This item allows you to save changes.

■ Discard Changes

This item allows you to discard changes.

■ Restore Defaults

This item allows you to restore/ load default values for all the setup options.

■ Save as User Defaults

This item allows you to save the changes done so far as user defaults.

■ Restore User Defaults

This item allows you to restore the user defaults to all the setup options.



Chapter 5

Product Application

5.1 Where to download drivers?

Please go to the CINCOZE website to download the drivers for DV-1100 series.

5.2 Where to find the technical documents?

Please go to the [CINCOZE website](#) to find the technical documents for DV-1100 series.

Catalog	Document Title
Application Notes	DIO Application Guide
	DIO Technical Guide
	Instant Reboot Application Guide
	WDT Application Guide
	WDT Technical Guide
Configure & Installation	AT ATX Power Mode Function Manual
	BIOS Administrator User Password
	Clear CMOS Function Manual
	COM Port Function Manual
	CSM Function Manual
	Digital I/O Function Manual
	How to import Secure Boot Key?
	How to restore Windows image with Clonezilla?
	How to set TPM function under Windows?
	How to stop automatic driver update in Windows
	How to Update BIOS and ME under UEFI shell?
	How to Update BIOS under UEFI shell?
	How to Update BIOS under Windows?
	IGN Module User Manual
	PXE Function Manual
	Remote Switch Function Manual
	Wake On LAN Function Manual
WDT Function Manual	

cincoze

© 2024 Cincoze Co., Ltd. All rights reserved.

The Cincoze logo is a registered trademark of Cincoze Co., Ltd.

All other logos appearing in this catalog are the intellectual property of the respective company, product, or organization associated with the logo.

All product specifications and information are subject to change without notice.