



User Manual

ASMB-976 Series

**Dual LGA 4189 Intel® 3rd Gen
Xeon® Scalable Processor
Server Board with 16 DDR4,
4 PCIe x16, 10 SATA3, 9 USB 3.2
gen1, Dual 10GbE, IPMI**

ADVANTECH

Enabling an Intelligent Planet

Copyright

The documentation and the software included with this product are copyrighted 2022 by Advantech Co., Ltd. All rights are reserved. Advantech Co., Ltd. reserves the right to make improvements in the products described in this manual at any time without notice. No part of this manual may be reproduced, copied, translated, or transmitted in any form or by any means without the prior written permission of Advantech Co., Ltd. The information provided in this manual is intended to be accurate and reliable. However, Advantech Co., Ltd. assumes no responsibility for its use, nor for any infringements of the rights of third parties that may result from its use.

Acknowledgments

Intel and Pentium are trademarks of Intel® Corporation.

Microsoft Windows and MS-DOS are registered trademarks of Microsoft® Corp.

All other product names or trademarks are properties of their respective owners.

Product Warranty (2 years)

Advantech warrants the original purchaser that each of its products will be free from defects in materials and workmanship for two years from the date of purchase.

This warranty does not apply to any products that have been repaired or altered by persons other than repair personnel authorized by Advantech, or products that have been subject to misuse, abuse, accident, or improper installation. Advantech assumes no liability under the terms of this warranty as a consequence of such events.

Because of Advantech's high quality-control standards and rigorous testing, most customers never need to use our repair service. If an Advantech product is defective, it will be repaired or replaced free of charge during the warranty period. For out-of-warranty repairs, customers will be billed according to the cost of replacement materials, service time, and freight. Please consult your dealer for more details.

If you believe your product to be defective, follow the steps outlined below.

1. Collect all the information about the problem encountered. (For example, CPU speed, Advantech products used, other hardware and software used, etc.) Note anything abnormal and list any onscreen messages displayed when the problem occurs.
2. Call your dealer and describe the problem. Please have your manual, product, and any helpful information readily available.
3. If your product is diagnosed as defective, obtain a return merchandise authorization (RMA) number from your dealer. This allows us to process your return more quickly.
4. Carefully pack the defective product, a completed Repair and Replacement Order Card, and a proof of purchase date (such as a photocopy of your sales receipt) into a shippable container. Products returned without a proof of purchase date are not eligible for warranty service.
5. Write the RMA number clearly on the outside of the package and ship the package prepaid to your dealer.

A Message to the Customer

Advantech Customer Services

Each and every Advantech product is built to the most exacting specifications to ensure reliable performance in the harsh and demanding conditions typical of industrial environments. Whether your new Advantech equipment is destined for the laboratory or the factory floor, you can be assured that your product will provide the reliability and ease of operation for which the name Advantech has come to be known. Your satisfaction is our primary concern. Here is a guide to Advantech's customer services. To ensure you get the full benefit of our services, please follow the instructions below carefully.

Technical Support

We want you to get the maximum performance from your products. So if you run into technical difficulties, we are here to help. For the most frequently asked questions, you can easily find answers in your product documentation. These answers are normally a lot more detailed than the ones we can give over the phone.

So please consult this manual first. If you still cannot find the answer, gather all the information or questions that apply to your problem, and with the product close at hand, call your dealer. Our dealers are well trained and ready to give you the support you need to get the most from your Advantech products. In fact, most problems reported are minor and are easily solved over the phone.

In addition, free technical support is available from Advantech engineers every business day. We are always ready to give advice on application requirements or specific information on the installation and operation of any of our products.

Declaration of Conformity

FCC Class A

This equipment has been tested and found to comply with the limits for a Class A digital device, pursuant to part 15 of the FCC Rules. These limits are designed to provide reasonable protection against harmful interference when the equipment is operated in a commercial environment. This equipment generates, uses, and can radiate radio frequency energy and, if not installed and used in accordance with the instruction manual, may cause harmful interference to radio communications. Operation of this equipment in a residential area is likely to cause harmful interference. In this event, users are required to correct the interference at their own expense.

Initial Inspection

Before installing the motherboard, please make sure that the following materials have been shipped:

- 1 x ASMB-976 server board
- 1 x ASMB-976 startup manual
- 2 x Serial ATA HDD data cables
- 1 x I/O port bracket
- 2 x SATA power cable
- 1 x Warranty card
- 2 x Heatsink clip for CPU

If any of these items are missing or damaged, contact distributor or sales representative immediately. We have carefully inspected the ASMB-976 mechanically and electrically before shipment. It should be free of marks and scratches and in perfect working order upon receipt. When unpacking the ASMB-976, check it for signs of shipping damage. (For example, damaged box, scratches, dents, etc.) If it is damaged or it fails to meet the specifications, notify our service department or local sales representative immediately. Also notify the carrier. Retain the shipping carton and packing material for inspection by the carrier. After inspection, we will make arrangements to repair or replace the unit.

Order Information

Part Number	Chipset	Memory	GbE/10GbE LAN	IPMI	VGA Chip
ASMB-976-00A1	C621A	DDR4 RDIMM	2/-	-	AST 2510
ASMB-976T2-00A1	C621A	DDR4 RDIMM	2/2	Yes	AST 2500

Contents

Chapter 1	Overview.....	1
1.1	Introduction	2
1.2	Features	2
1.3	Specifications	3
	Table 1.1: Specifications	3
1.4	Board Layout, Jumpers and Connectors.....	5
	Figure 1.1 Board Layout	5
	Figure 1.2 Rear I/O of full SKU	5
	Table 1.2: Onboard LAN LED Color Definition	6
	Table 1.3: Onboard LAN LED Color Definition	6
	Table 1.4: Jumpers.....	7
	Table 1.5: Connectors	7
	Table 1.6: Onboard LED.....	9
1.5	Block Diagram.....	9
	Figure 1.3 Block Diagram	9
1.6	System Memory	9
1.7	Memory Installation Procedures.....	10
	Table 1.7: DIMM Configuration with Single CPU.....	10
	Table 1.8: DIMM Configuration with Dual CPU	11
	Table 1.9: DCPMM Population Matrix	11
1.8	Processor Installation.....	12
Chapter 2	Connections.....	15
2.1	Introduction	16
2.2	USB Ports and LAN Port (USB1~USB10, LAN1~LAN5).....	16
2.3	VGA Connector (VGA1).....	17
2.4	Serial Ports (COM1~2).....	17
2.5	PS2 Keyboard and Mouse Connectors (KBMS1)	18
2.6	CPU Fan Connector (CPUFAN0~1).....	18
2.7	System Fan Connector (SYSFAN0~6).....	19
2.8	Front Panel Connector (JFP1)	19
	2.8.1 Power LED (JFP3).....	20
	Table 2.1: ATX Power Supply LED Status	20
	2.8.2 External Speaker (JFP2 pins 1, 4, 7, 10).....	20
	2.8.3 HDD LED Connector (JFP1 Pins 2 & 5)	20
	2.8.4 Reset Connector (JFP1 Pins 9 & 12).....	20
2.9	Case Open (JCASE1).....	21
2.10	SATA SGPIO (SGPIO1).....	21
2.11	Front Panel LAN Indicator Connector (LANLED1).....	22
2.12	SATA and sSATA (SATA0~7, sSATA0~1)	22
2.13	M.2 Connector (sSATA3 and PCIe gen3 and PCIe gen4).....	23
2.14	PCIe Expansion Slots	24
2.15	Auxiliary Power Connector (ATXPWR1/ATX12V1/ATX12V/ATX12V3/ ATX12V4).....	25
2.16	HD Audio Interface Connector (HDAUD1).....	25
2.17	LPC Connector (LPC1)	26
2.18	CMOS Clear and ME Update Connector (JCMOS1, JME1).....	26
2.19	PMBUS Connector (PMBUS1).....	27
2.20	Front Panel SMBUS Connector (SMBUS1).....	27
2.21	BMC IC Socket (CN2).....	28
2.22	VOLT1 Connector (VOLT1)	28
2.23	GPIO Connector (GPIO1)	29

2.24	Intel Virtual RAID (VROC1).....	29
2.25	NVMe RAID LED Control (PEHP1).....	30
Chapter 3	AMI BIOS.....	31
3.1	Introduction	32
3.2	BIOS Setup	33
3.2.1	Main Menu	33
3.2.2	Advanced BIOS Features Setup.....	34
3.2.3	Platform Configuration	54
3.2.4	Socket Configuration	62
3.2.5	Server Management	82
3.2.6	Security.....	88
3.2.7	Boot	92
3.2.8	Save & Exit	93
Chapter 4	Chipset Software Installation Utility	95
4.1	Before Beginning	96
4.2	Introduction	96
4.2.1	Main Menu	96
Chapter 5	Graphic Setup	97
5.1	Introduction	98
5.2	Windows Series Driver Setup	98
Chapter 6	LAN Configuration & USB 3.0	99
6.1	LAN Configuration.....	100
6.1.1	Introduction	100
6.1.2	Features.....	100
6.1.3	Installation.....	100
6.1.4	Windows Series Driver Setup (LAN).....	100
6.2	USB 3.2 gen1.....	101
6.2.1	Introduction	101
6.2.2	Windows Series Driver Setup	101
6.3	SATA & PCIe SSD RAID	101
Appendix A	Programming the Watchdog Timer	103
A.1	Watchdog Timer Overview.....	104
A.2	Programming the Watchdog Timer	104
Appendix B	I/O Pin Assignments	107
B.1	USB3.2 gen1 Header(USB3_34, USB3_56, USB3_78)	108
	Table B.1: USB Header	108
B.2	VGA Connector (VGA1).....	108
	Table B.2: VGA Connector	108
B.3	RS-232 Interface (COM2).....	109
	Table B.3: RS-232 Interface	109
B.4	External Keyboard Connector (KBMS1)	109
	Table B.4: External Keyboard Connector	109
B.5	CPU and System Fan Power Connector (CPUFAN0~1,	

	SYSFAN0~SYSFAN6).....	110
	Table B.5: Fan Power Connector.....	110
B.6	Power LED (JFP3).....	110
	Table B.6: Power LED.....	110
B.7	External Speaker Connector (JFP2).....	110
	Table B.7: External Speaker Connector.....	110
B.8	Reset Connector (JFP1).....	111
	Table B.8: Reset Connector.....	111
B.9	HDD LED Connector (JFP1).....	111
	Table B.9: HDD LED Connector.....	111
B.10	ATX Soft Power Switch (JFP1).....	111
	Table B.10:ATX Soft Power Switch.....	111
B.11	Front Panel SMBus Connector (SMBUS1).....	112
	Table B.11:Front Panel SMBus Connector (SMBUS1).....	112
B.12	USB/LAN Ports (IPMI_LAN5_USB3_12).....	112
	Table B.12:USB Port.....	112
	Table B.13:Giga LAN 10/100/1000 Base-T RJ-45 Port.....	112
B.13	Audio Connector (HDAUD1).....	113
	Table B.14:Front Panel Audio Connector.....	113
B.14	Alarm Board Connector (VOLT1).....	113
	Table B.15:Alarm Board Connector.....	113
B.15	Case Open Connector (JCASE1).....	113
	Table B.16:Case Open Connector.....	113
B.16	Front Panel LAN LED Connector (LANLED1).....	114
	Table B.17:LAN LED Connector.....	114
B.17	SATA SGPIO (SGPIO1/SGPIO2).....	114
	Table B.18:SATA SGPIO Connector.....	114
B.18	LPC Connector (LPC1).....	115
	Table B.19:LPC Connector (LPC1).....	115
B.19	Clear CMOS and Update ME Connector (JCMOS1, JME1).....	115
	Table B.20:Clear CMOS and Update ME Connector (JCMOS1, JME1).....	115
B.20	PMBUS Connector (PMBUS1).....	116
	Table B.21:PMBUS Connector (PMBUS1).....	116
B.21	GPIO Connector (GPIO1).....	116
	Table B.22:GPIO Connector (GPIO1).....	116

Chapter 1

Overview

1.1 Introduction

The ASMB-976 serverboard is the most advanced Intel Xeon Processor Scalable Family series board for server-grade IPC applications that require high-performance computing power & multi-expansion slots. This serverboard supports Intel Xeon Processor Scalable Family series processor and DDR4 ECC-REG 2400/2666/2933/3200 MHz memory up to 2048 GB. ASMB-976 provides four PCIe x16, and seven PCIe x8 slots in PCIe Gen4.0 high speed. In addition, the ASMB-976T2 has dual Gigabit and dual 10GbE Ethernet LAN ports that eliminate network bottlenecks. A fifth RJ-45 LAN connector (LAN5) is dedicated for IPMI function that allows remote control management. One RJ-45 LAN jack (LAN 4) from 10GbE port can also be used as IPMI LAN. High reliability and outstanding performance makes ASMB-976 the ideal platform for industrial server/networking applications.

By using the Intel C621A chipset, the ASMB-976 offers a variety of features such as 9 x USB3.2 gen1 and 1 x USB 2.0 connectivity, 10 x onboard SATA III and 2 x M.2 (SATA/PCIe x4 from PCH + PCIe x4 from CPU0) interface. The 10 x SATA ports support software RAID 0, 1, 10 and 5 (Windows only*), and with the latest Intel RSTe (Rapid Storage Technology Enterprise) it provides a compelling RAID solution for NVMe SSDs via Intel VROC (Virtual RAID on Chip) HW key.

These powerful I/O capabilities ensure even more reliable data storage capabilities and high-speed I/O peripheral connectivity.

Note!



1. *IPMI module will be included in ASMB-976T2 SKU.*
2. *One USB 2.0 ports (1*Type- A) and nine USB 3.2 gen1 ports (6 ports from on-board 20-pin header and 1 port from Type-A).*
3. *Please refer to the release note of each Linux OS for Intel's C621A chipset SATA RAID function support.*

1.2 Features

General

- **Intel Xeon Processor Scalable Family support:** ASMB-976 is equipped with single CPU socket to support Intel Xeon Platinum/Gold/Silver series up to 40-core processors.
- **High performance I/O capability:** 2 x 10GbE (T2 SKU Only) + 2 x GbE LAN, 4 x PCIe x16 slot (x16 link) + 7 x PCIe x8 slot (x8 link), 10 x SATA and 2 x M.2 connectors, 9 x USB 3.2 gen1 and 1 x USB 2.0 (1 x Type-A).
- **Outstanding industrial features:** ASMB-976 provides industrial features like long product lifecycle, reliable operation under wide temperature range, watchdog timer, etc.
- **IPMI 2.0 support:** ASMB-976I/ASMB-976T2 equipped with ASPEED 2500 BMC chip supports IPMI 2.0 (Intelligent Platform Management Interface 2.0) via sharing LAN port.
- **KVM over IP:** KVM over IP function allows BIOS level remote control of ASMB-976T2 sku system through your own computer.

1.3 Specifications

Table 1.1: Specifications	
Processor	
CPU	<ul style="list-style-type: none"> ■ Dual Intel LGA4189 Xeon processor sockets ■ Supports Intel 3rd Gen Xeon Scalable family, up to 40 cores ■ Supports the TDP of processor up to 270W (Please consider extended air thermal solution while using CPU > 205W TDP)
System Memory	
Memory Capacity	<ul style="list-style-type: none"> ■ Supports DDR4 memory bus ■ Total 16 memory slots provided ■ Supports up to 2 TB memory ■ 1 DIMM slot per channel, 8 channels per processor
Memory Type	Supports DDR4 400/2666/2933/3200 MHz RDIMM/LRDIMM modules
DIMM Sizes	Each memory slot supports 8GB, 16GB, 32GB, 64GB and 128GB (LRDIMM) memory modules
Memory Voltage	1.2 V
Error Detection	<ul style="list-style-type: none"> ■ Corrects single-bit errors (Using ECC memory) ■ Detects double-bit errors (Using ECC memory)
On-Board Devices	
Chipsets	Intel C621A PCH
Network controllers	<ul style="list-style-type: none"> ■ 2 x Intel X550 10GbE and 2 x Intel I210 Gigabit Ethernet Controller connected to PCH ■ Above network supports 10 GbE Base-T and 100/1000 Base-T, with RJ-45 output
VGA	ASPEED AST2500/2510 controller with 64 MB VGA memory provides basic 2D VGA function.
EC	ITE IT8528E chip provide motherboard keyboard mouse, RS-232, parallel port and hardware monitor functions
BMC	One Realtek 8201F Gigabit PHY connected to AST2500 for BMC remote management (ASMB-976T2 SKU)
Input/Output	
Storage	<ul style="list-style-type: none"> ■ Total 10 x SATA ports and 1 x M.2 (SATA/PCIe x4 gen3 compatible from PCH) provide 6 Gb/s and 8 Gb/s, and 1 x M.2 (PCIe x4 gen4 compatible from CPU) provide 16 Gb/s ■ RAID 0, 1, 5, 10 supports (Windows only. For Linux support please refer to note item 3 of chapter 1.1)
LAN	<ul style="list-style-type: none"> ■ 4 x RJ-45 LAN ports (2 x 10GbE + 2 x 10/100/1000 Base-T LAN) ■ 1 x RJ-45 Dedicated IPMI LAN port (10/100/1000 Base-T) for IPMI only, there is no regular LAN function (ASMB-976T2 SKU)
USB	<ul style="list-style-type: none"> ■ 2 x USB 3.2 gen1 ports at rear window ■ 3 x USB 3.2 gen1 internal header (6 ports) ■ 1 x USB 2.0 internal Type-A port ■ 1 x USB 3.2 gen1 internal Type-A port
Graphics	<ul style="list-style-type: none"> ■ 1 x VGA port.
Serial Port/Header	<ul style="list-style-type: none"> ■ 1 x RS232 port at rear window, 1 x internal header (2 x 5P pitch: 2.50 mm), both ports are RS-232 (5V)
Keyboard/Mouse	<ul style="list-style-type: none"> ■ PS/2 keyboard and mouse internal header (onboard)

Table 1.1: Specifications	
Power Connector	
CPU Power	4 x 8-pin SSI EPS 12V power connector for CPU & Memory power (12V)
PCIe slot power	2 x 8-pin power connector for PCIe slot 12V input
Expansion Slots	
PCI-express	<ul style="list-style-type: none"> ■ 4 x PCIe x16 slot (Gen4 x16 link) <ul style="list-style-type: none"> – PCIEX16_SLOT3 (from CPU 0) – PCIEX16_SLOT5 (from CPU 0) – PCIEX16_SLOT7 (from CPU 1) – PCIEX16_SLOT9 (from CPU 1) ■ 4 x PCIe x8 slot (Gen4 x8 link) <ul style="list-style-type: none"> – PCIEX8_SLOT1 (from CPU0) – PCIEX8_SLOT2 (from CPU1) – PCIEX8_SLOT4 (from CPU1) – PCIEX8_SLOT6 (from CPU0) – PCIEx8 SLOT8 (from CPU0) – PCIEx8 SLOT10 (from CPU1) – PCIEx8 SLOT11 (from CPU1)
System BIOS	
BIOS Type	256 Mb SPI Flash EEPROM with AMI BIOS
PC Health Monitoring	
Voltage	Monitors for CPU Cores, +3.3V, +5V, +12V, +5V Standby, VBAT
FAN	<ul style="list-style-type: none"> ■ Two 4-pin headers for CPU cooler and five 4-pin headers for system fans, and two 8-pin headers for external fans ■ All fans with tachometer status monitoring (except SYSFAN6) ■ Thermal control for all fan connectors
Temperature	<ul style="list-style-type: none"> ■ Monitoring for CPU (PECI) ■ Monitoring for System (EC)
Other Features (Case Open)	<ul style="list-style-type: none"> ■ Chassis intrusion detection ■ Chassis intrusion header
Operating Environment/Compliance	
RoHS	RoHS Compliant 6/6 Pb Free
Environmental Spec.	<ul style="list-style-type: none"> ■ Operating Temperature: 0 to 40° C ■ Non-operating Temperature: -40 to 85° C ■ Operating Relative Humidity: 10% to 90% (non-condensing) ■ Non-operating Relative Humidity: 10% to 95% (non-condensing)

1.4 Board Layout, Jumpers and Connectors

Connectors on the ASMB-976 are linked to external devices such as hard disk drives. In addition, ASMB-976 has a number of jumpers that are used to configure the system for specific applications.

The tables below list the functions of each jumper and connector. Later sections in this chapter give instructions for setting jumpers. Chapter 2 gives instructions for connecting external devices to ASMB-976.

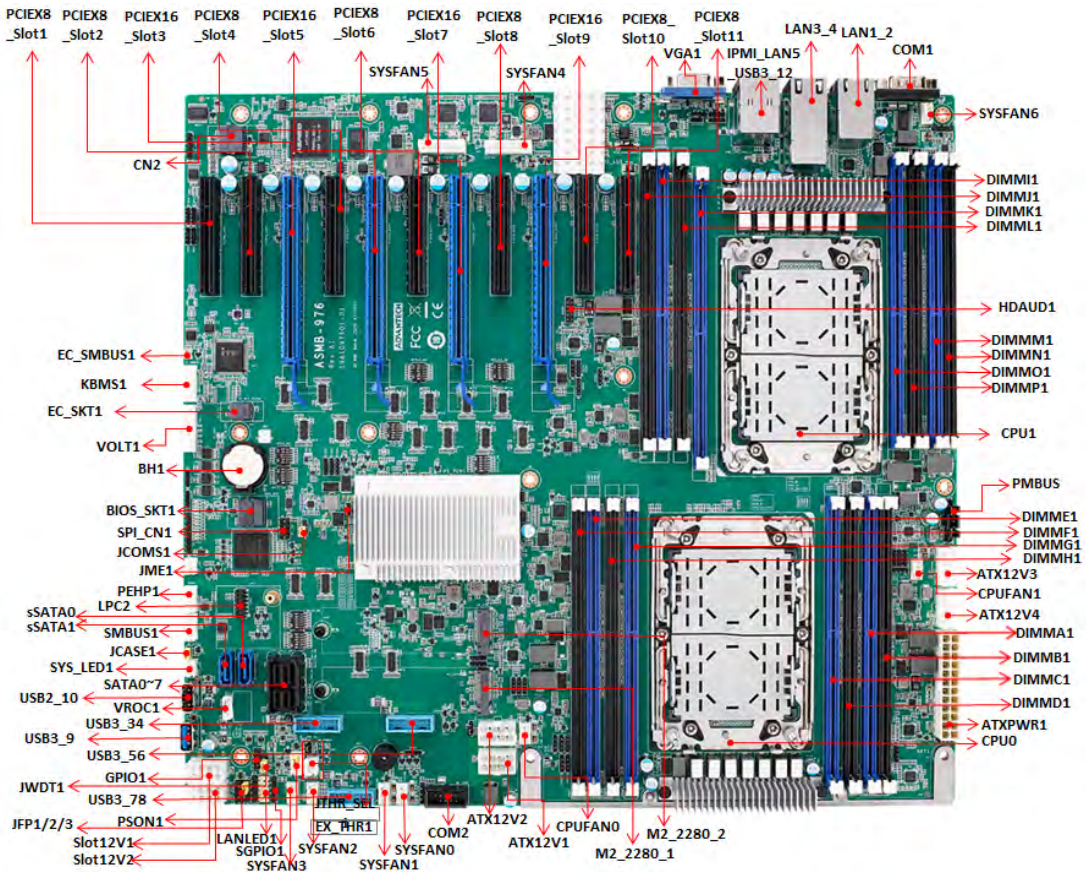

Figure 1.1 Board Layout

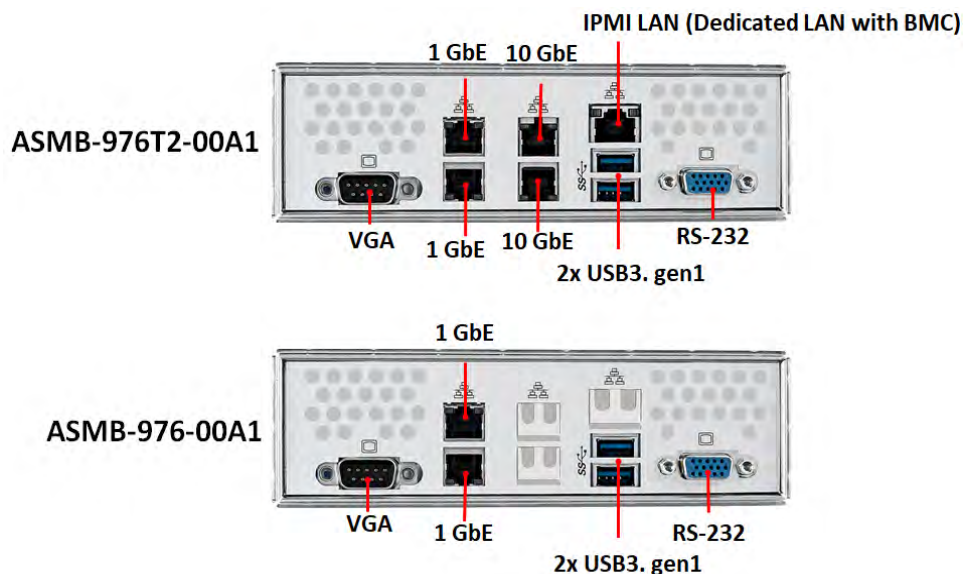

Figure 1.2 Rear I/O of full SKU

Table 1.2: Onboard LAN LED Color Definition

10/100/1000 Mbps LAN Mbps LAN Link/Activity LED Scheme			
		LAN1 & LAN2 (1G)	
			Left LED
10 Mbps	Link Active	Off Off	Green Blinking green
100 Mbps	Link Active	Amber Amber	Green Blinking green
1000 Mbps	Link Active	Green Green	Green Blinking green
No Link		Off	Off

Table 1.3: Onboard LAN LED Color Definition

10/100/1000 & 10G bps LAN Mbps LAN Link/Activity LED Scheme			
		LAN3 & LAN4 (10G)	
			Left LED
100M bps	Link Active	Off Off	Green Blinking green
1G bps	Link Active	Amber Amber	Green Blinking green
10G bps	Link Active	Green Green	Green Blinking green
No Link		Off	Off

Table 1.4: Jumpers		
Label	Function	Default
JCMOS1	CMOS Clear	1-2
JME1	ME update	1-2
JWDT1	Watch Dog Reset	1-2
PSOEN1	AT(1-2) / ATX(2-3)	2-3
JCASE1	Chassis case open alarm	1-2
JTHR_SEL	On board(1-2)/external thermistor(2-3)	1-2

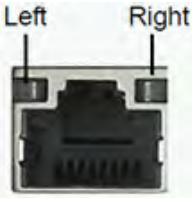

Keep CMOS data/ disable ME update/	Clear CMOS data/ Enable ME update/
---------------------------------------	---------------------------------------

Table 1.5: Connectors	
Label	Function
ATX12V1/V2	SSI EPS 12V auxiliary power connector (for CPU0) and memory
ATXV3/V4	SSI EPS 12V auxiliary power connector (for CPU1) and memory
ATXPWR1	SSI EPS 24-pin main power connector (for system)
BH2	For optional battery kit
BIOS_SKT1	BIOS SPI ROM
CN2	BMC IC socket for IPMI function (ASMB-976T2 SKU only)
COM2	Serial port: RS-232
CPU0	Intel LGA4189 CPU0 socket
CPU1	Intel LGA4189 CPU1 socket
CPUFAN0	CPU0 fan connector (4-pin)
CPUFAN1	CPU1 fan connector (4-pin)
DIMMA1	Channel A1 DIMMA1 of CPU0
DIMMB1	Channel B1 DIMMB1 of CPU0
DIMMC1	Channel C1 DIMMC1 of CPU0
DIMMD1	Channel D1 DIMMD1 of CPU0
DIMME1	Channel E1 DIMME1 of CPU0
DIMMF1	Channel F1 DIMMF1 of CPU0
DIMMG1	Channel G1 DIMMG1 of CPU0
DIMMH1	Channel H1 DIMMH1 of CPU0
DIMMI1	Channel I1 DIMMI1 of CPU1
DIMMJ1	Channel J1 DIMMJ1 of CPU1
DIMMK1	Channel K1 DIMMK1 of CPU1
DIMML1	Channel L1 DIMML1 of CPU1
DIMMM1	Channel M1 DIMMM1 of CPU1
DIMMN1	Channel N1 DIMMN1 of CPU1
DIMMO1	Channel O1 DIMMO1 of CPU1
DIMMP1	Channel P1 DIMMP1 of CPU1
EC_SMBUS1	For EC debug

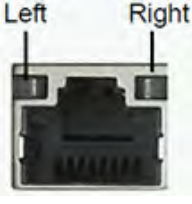
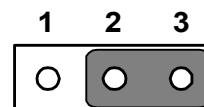
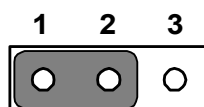
Table 1.5: Connectors	
EX_THR1	Connector for external thermistor
GPIO1	GPIO function for customize usage
HDAUD1	Audio header
JFP1/JFP2/JFP3	Front panel pin header
KBMS1	For additional keyboard/mouse
LAN1_2, LAN3_4	RJ-45 LAN connector
LANLED1	LAN LED extension connector
LPC1	LPC port for debug & TPM module
SSATA4, SSATA5	SATA port 4/5 for M.2 2242 SATA SSD
PMBUS1	PMBUS connector to communicate with power supply
PEHP1	NVMe RAID LED control
SATA0~SATA7	Serial ATA0~7
SSATA0~SSATA2	sSATA port 0~2
SGPIO1	Supports Serial_Link interface for onboard SATA connections
SLOT1	PCIE x 8 slot of CPU0
SLOT2	PCIE x 8 slot of CPU1
SLOT3	PCIE x 16 slot of CPU0
SLOT4	PCIE x 8 slot of CPU1
SLOT5	PCIE x 16 slot of CPU0
SLOT6	PCIE x 8 slot of CPU0
SLOT7	PCIE x 16 slot of CPU1
SLOT8	PCIE x 8 slot of CPU0
SLOT9	PCIE x 16 slot of CPU1
SLOT10	PCIE x 8 slot of CPU1
SLOT11	PCIE x 8 slot of CPU1
SLOT12V1/V2	For PCIe slot 12V input only
SMBUS1	Front panel SMBus header
SPI_CN1	Connector for BIOS update tool
SPI_SKT1	EC EEPROM
SYSFAN0-SYSFAN7	System FAN connector
SYS_LED1	System LED connector
USB3_34, USB3_56, USB3_78	USB 3.2 gen1 port 3,4,5,6,7,8 (20 pin header)
USB3_9	USB 3.2 gen1 port 9 (Type A)
USB2_10	USB 2.0 port 10 (Type-A)
LAN5_USB3_12	RJ-45 LAN port + USB 3.2 gen1 port x 2 connectors
LAN1~LAN4	RJ-45 LAN port
VOLT1	Voltage display
VROC1	Intel Virtual RAID (VROC) key
VGA1_COM1	VGA and COM connector
COM2	Serial port: RS-232

Table 1.6: Onboard LED			
LED	Description	LED Definition	
5V_LED1	Power on LED	Off: Power off	On (Green): System is On
5VSB_LED1	Standby LED	Off: No input AC Power	On (Green): System is ON, in sleep mode, or in soft-off mode
LED3	BMC heartbeat LED (ASMB-976T2 SKU Only)	Blinking (Green): controller is working normally	

1.5 Block Diagram

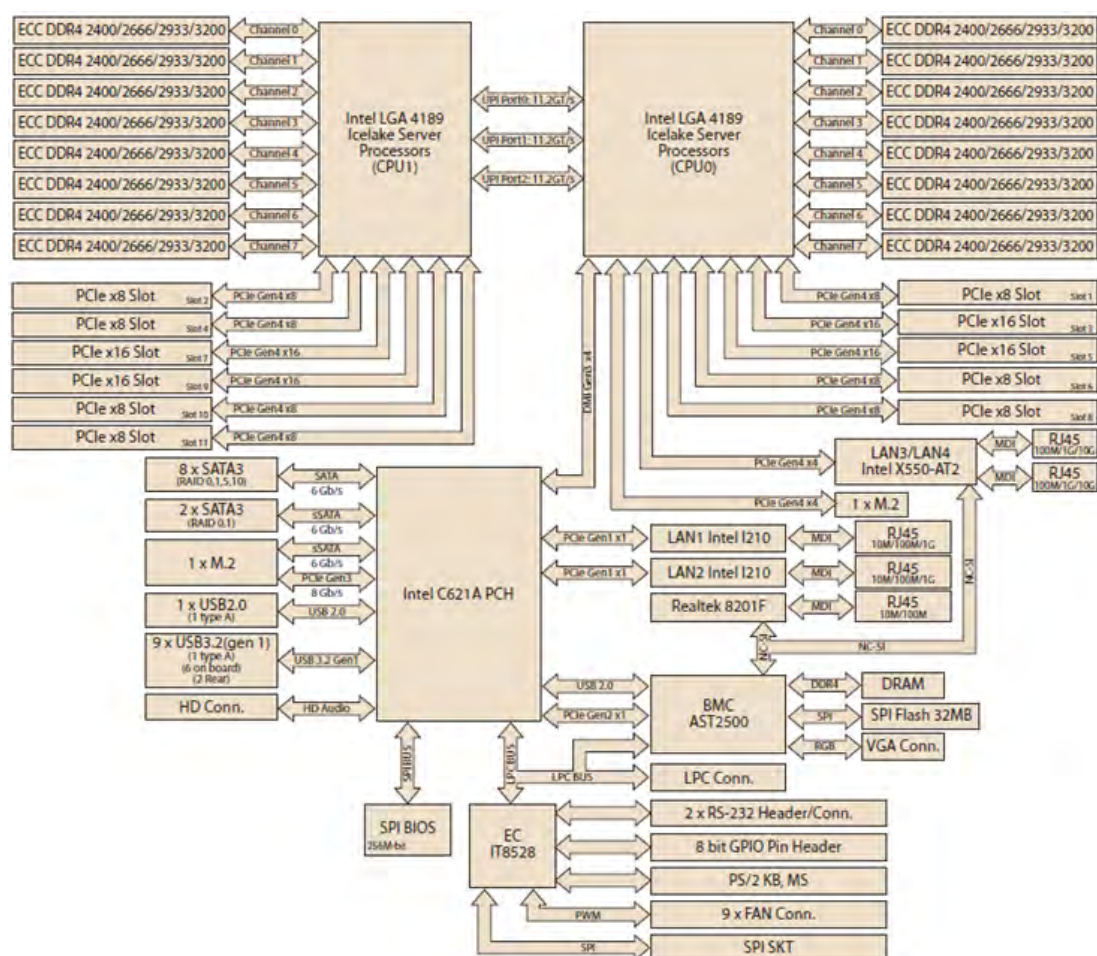

Figure 1.3 Block Diagram

1.6 System Memory

ASMB-976 has sixteen 288-pin memory slots for DDR4 2400/2666/2933/3200 MHz memory modules with maximum capacity of 2 TB (Maximum 128G (LRDIMM) for each DIMM). ASMB-976 supports registered DIMMs memory module.

1.7 Memory Installation Procedures

Memory performance is affected by different DIMM configurations. To reach optimal memory interleaving, be sure to install identical DIMM types with the same size, speed, and number of ranks on those memory slots corresponding to the correct processor.

The following table indicates recommended DIMM configurations with a single and dual processor. Base on the guideline, you may adjust your memory configuration according to your PCIe expansion card configuration.

The 3rd Gen Xeon Scalable (Silver-4xxx, Gold-5xxx/6xxx, Platinum-8xxx) processors support Optane DC persistent memory module (DCPMM).

Table 1.7: DIMM Configuration with Single CPU

Channel	DIMMA1	DIMMB1	DIMMC1	DIMMD1	DIMME1	DIMMF1	DIMMG1	DIMMH1	
Quantity of memory installed	1	V							
			V						
				V					
					V				
						V			
							V		
								V	
									V
	2	V				V			
				V				V	
		V		V					
						V		V	
		V			V				
			V				V		
					V				V
			V		V				
	4	V		V		V		V	
		V			V	V			V
			V		V		V		V
			V	V			V	V	
	6	V	V	V		V	V	V	
		V		V	V	V		V	V
		V	V		V	V	V		V
			V	V	V		V	V	V
	8	V	V	V	V	V	V	V	

Note! 3, 5, 7 DIMMs are not recommended DIMM population.



Table 1.8: DIMM Configuration with Dual CPU

Channel	DIM-MA1	DIMM-B1	DIM-MC1	DIM-MD1	DIMM-E1	DIMM-F1	DIM-MG1	DIMM-H1	DIM-MI1	DIM-MJ1	DIM-MK1	DIM-ML1	DIM-MM1	DIMM-N1	DIM-MO1	DIM-MP1	
Quantity of memory installed	2	V							V								
			V								V						
				V								V					
					V								V				
						V								V			
							V								V		
								V								V	
									V								V
	4	V				V				V				V			
				V				V				V				V	
		V		V						V		V					
						V		V					V		V		
		V			V					V			V				
			V				V					V			V		
					V				V				V				V
			V		V						V		V			V	
8	V		V		V		V		V		V		V		V		
	V			V	V			V	V			V	V			V	
		V		V		V		V		V		V		V		V	
		V	V			V	V			V	V			V	V		
12	V	V	V		V	V	V		V	V	V		V	V	V		
	V		V	V	V			V	V	V		V	V	V		V	
		V	V	V		V	V	V		V	V	V		V	V	V	
		V	V	V		V	V	V		V	V	V		V	V	V	
16	V	V	V	V	V	V	V	V	V	V	V	V	V	V	V	V	

Note! 1, 3, 5, 7, 9, 11 DIMMs are not recommended DIMM population when dual CPU were installed.



Table 1.9: DCPMM Population Matrix

Symmetric Population within CPU0								
mode	DIMMA1	DIMMB1	DIMMC1	DIMMD1	DIMME1	DIMMF1	DIMMG1	DIMMH1
1LM +AD MM 1/2 perf (1)	DRAM	DCPMM	DRAM	DCPMM	DRAM	DCPMM	DRAM	DCPMM
1LM +AD MM 1/2 perf (2)	DCPMM	DRAM	DCPMM	DRAM	DCPMM	DRAM	DCPMM	DRAM
Symmetric Population within CPU1								
mode	DIMMI1	DIMMJ1	DIMMK1	DIMML1	DIMMM1	DIMMN1	DIMMO1	DIMMP1
1LM +AD MM 1/2 perf (1)	DRAM	DCPMM	DRAM	DCPMM	DRAM	DCPMM	DRAM	DCPMM
1LM +AD MM 1/2 perf (2)	DCPMM	DRAM	DCPMM	DRAM	DCPMM	DRAM	DCPMM	DRAM

- AD: App Direct Mode; MM: Memory Mode; AD+MM: Mixed Mode.
- DRAM: RDIMM, 3DS RDIMM, LRDIMM, 3DS LRDIMM
- Any capacity of DCPMM is allowed

1.8 Processor Installation

The ASMB-976 is designed for Intel Xeon processor scalable family.

1. Remove dust cover.

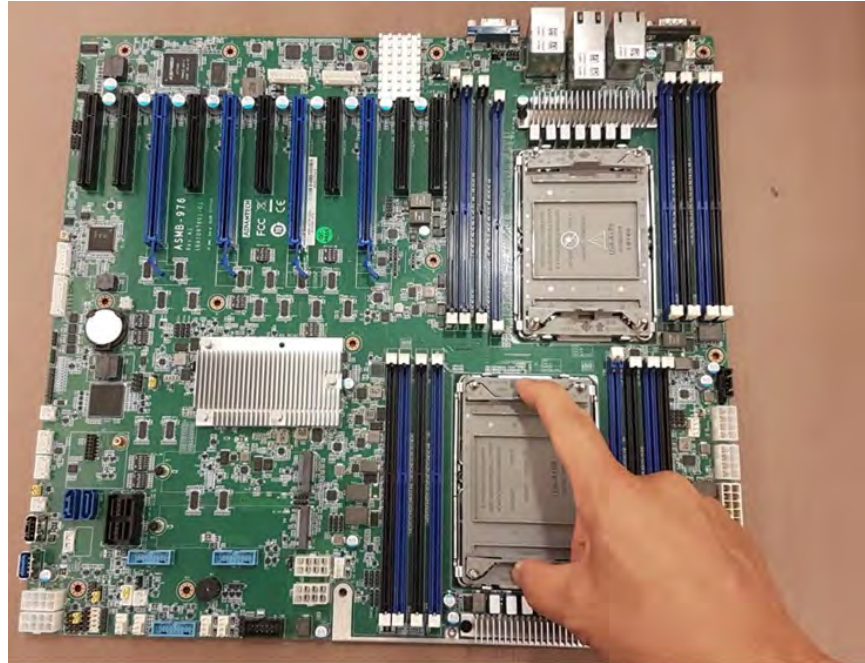

2. Install CPU on CPU clip and align pin 1 mark.

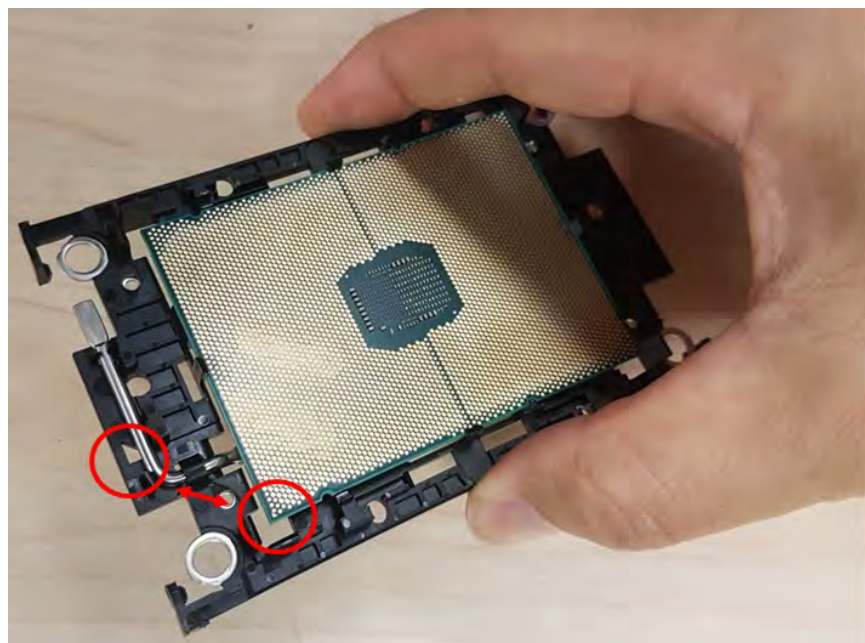

3. Install the CPU clip assembly on the heatsink as a processor + heatsink module.

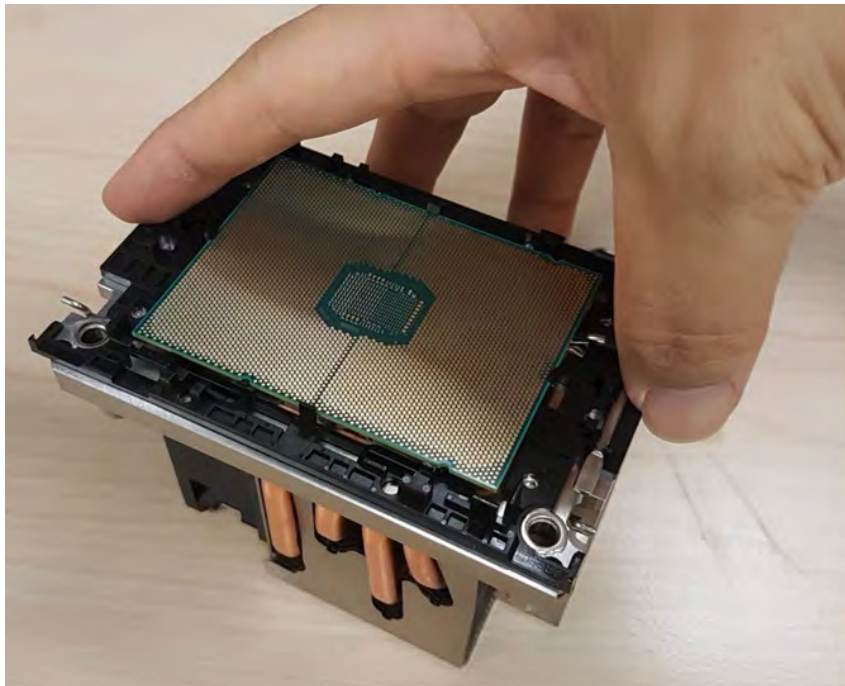

4. Put the processor heatsink module into the motherboard bolster plate by using a T-30 screw driver (follow heatsink label direction 1-2-3-4).



Chapter 2

Connections

2.1 Introduction

You can access most of the connectors from the top of the board as it is being installed in the chassis. If you have a number of cards installed, you may need to partially remove a card to make all the connections.

2.2 USB Ports and LAN Port (USB1~USB10, LAN1~LAN5)

The USB ports comply with USB 2.0 & 3.2 gen1 Transmission rates of up to 480 Mbps (USB 2.0) / 5Gbps (USB 3.2 gen1) and fuse protection are supported. The USB interface can be disabled in the system BIOS setup.

ASMB-976 is equipped with two 10GbE and two 1GbE LAN ports. They are all with RJ-45 jacks and supported by all major network operating systems. LAN5 is a dedicated LAN port for IPMI function. One of 10 GbE LAN (LAN3) can be used as IPMI LAN as well for system management.

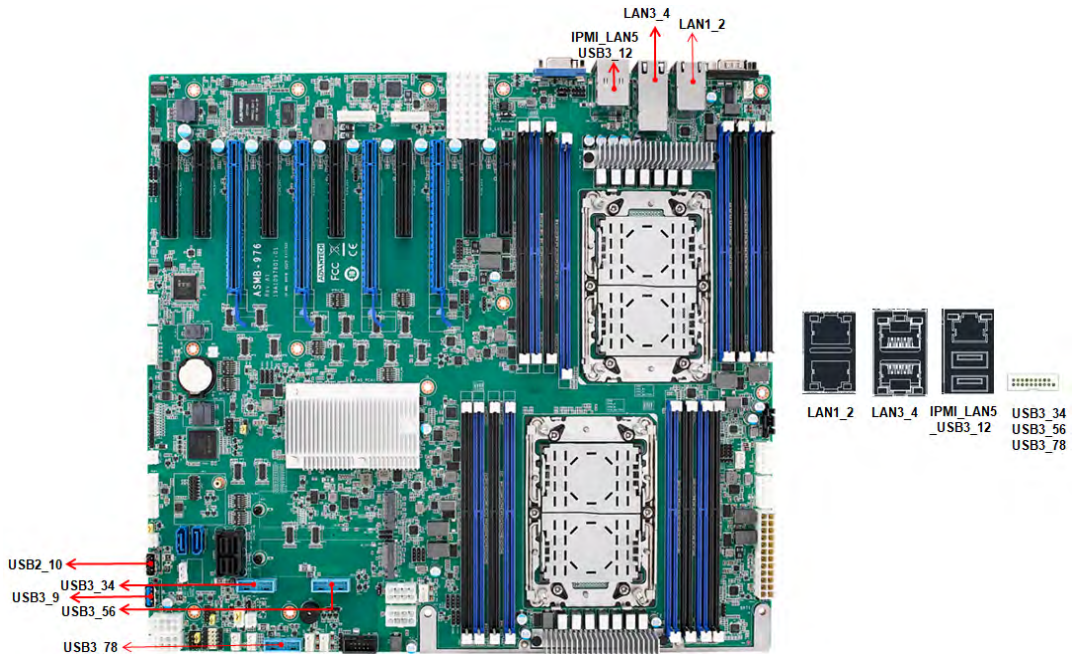

2.3 VGA Connector (VGA1)

The ASMB-976 includes a VGA interface that can drive conventional CRT and LCD displays.

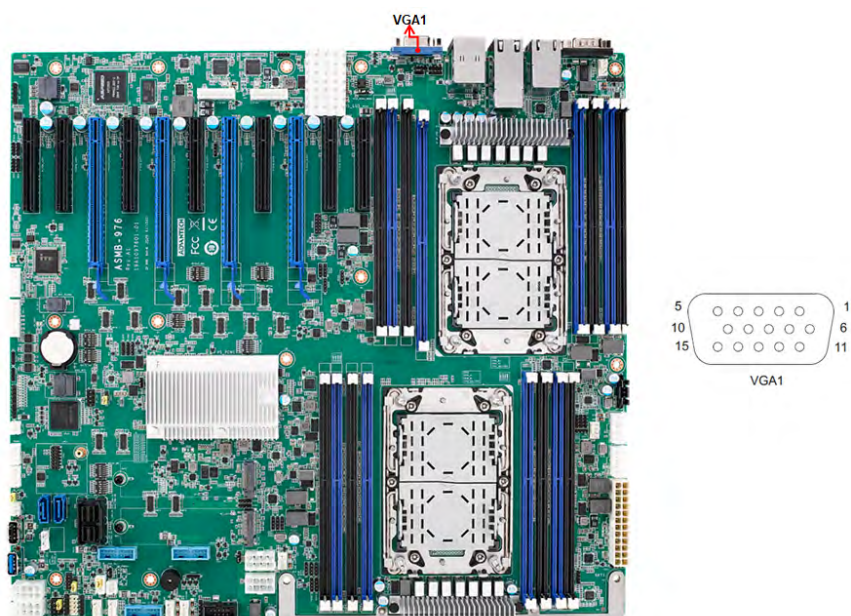

2.4 Serial Ports (COM1~2)

The ASMB-976 offers one serial port on the rear plate and one 2.54mm pitch 9-pin header onboard.

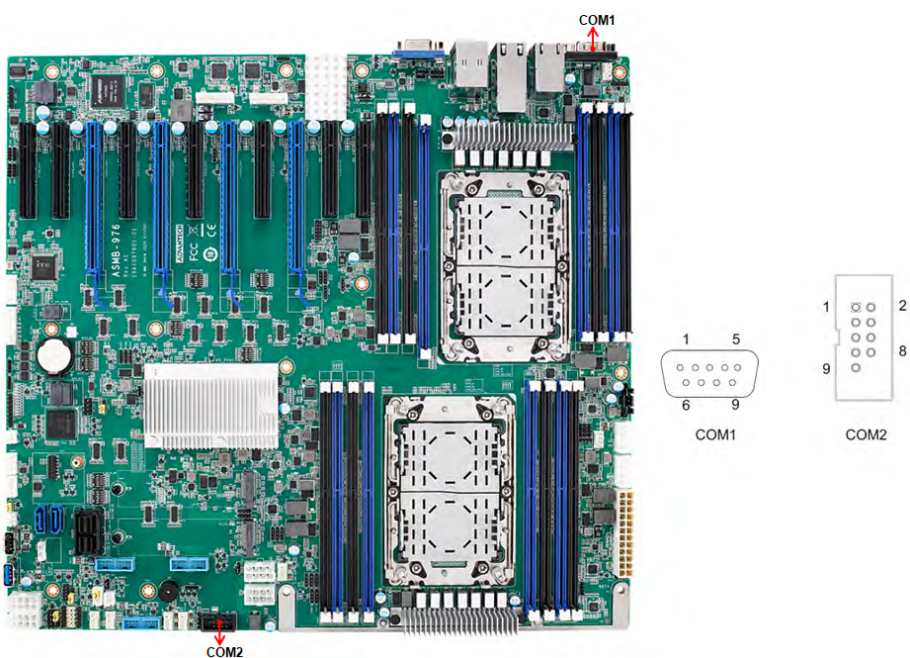

2.5 PS2 Keyboard and Mouse Connectors (KBMS1)

The 6-pin KBMS1 connector is for additional keyboard & mouse device usage.

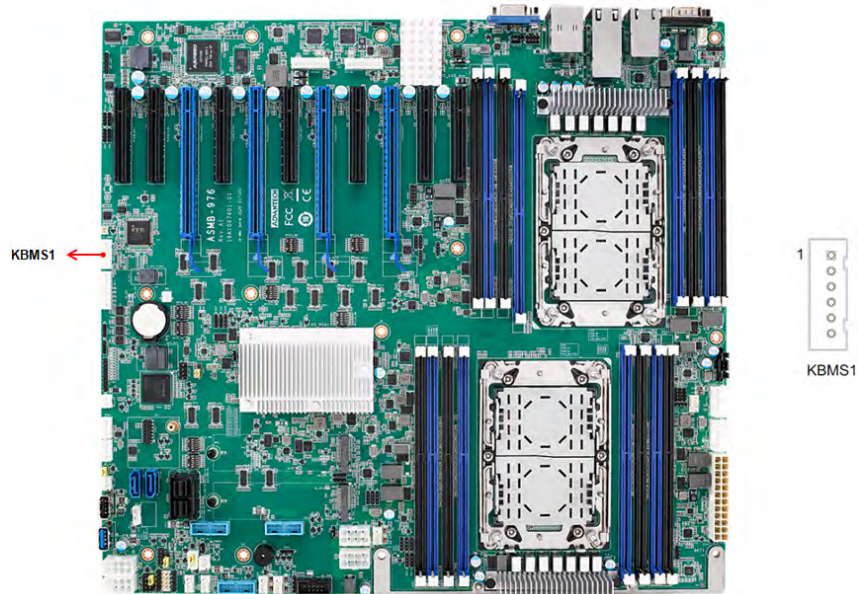

2.6 CPU Fan Connector (CPUFAN0~1)

If a fan is used, this connector supports cooling fans that draw up to 1.5A (18W).

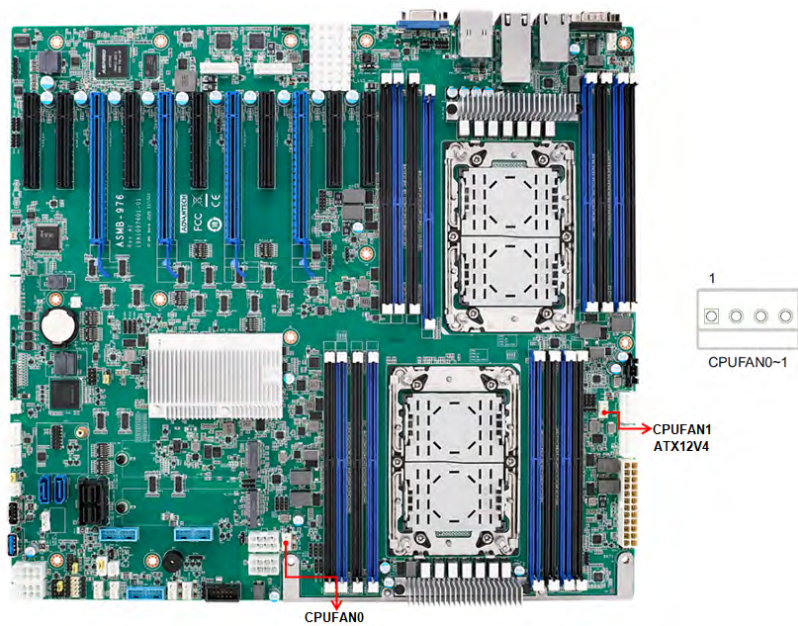

2.7 System Fan Connector (SYSFAN0~6)

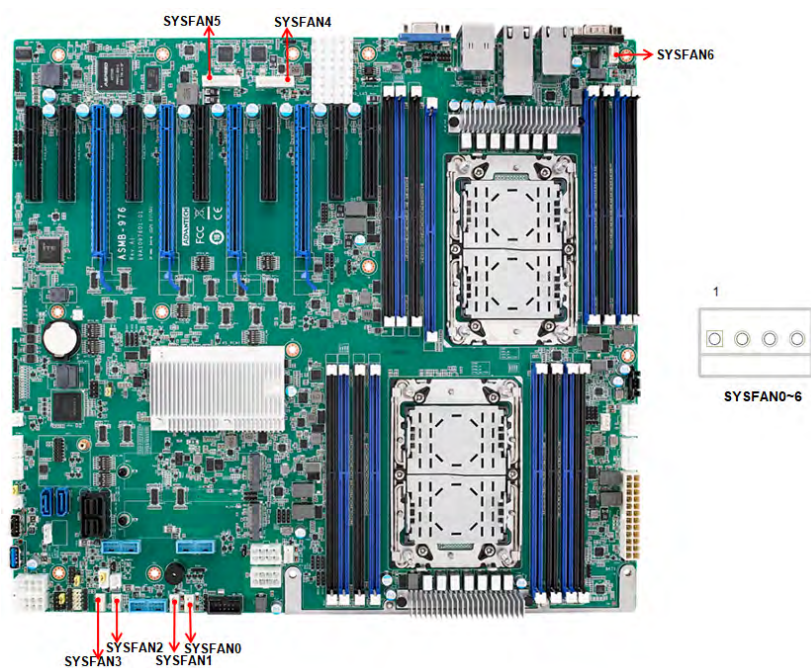

2.8 Front Panel Connector (JFP1)

There are several external switches and LEDs to monitor and control the ASMB-976.

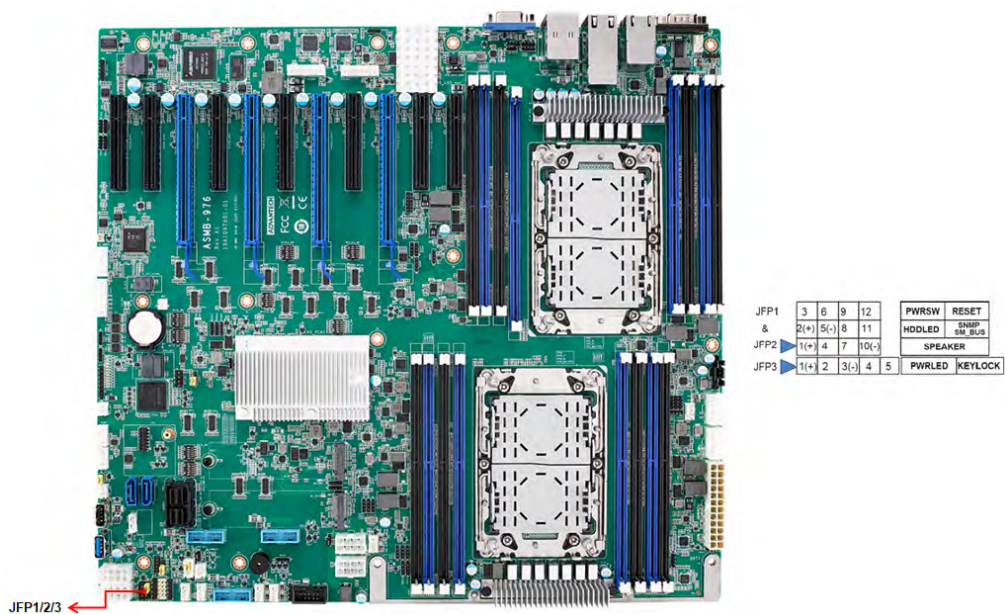

2.8.1 Power LED (JFP3)

JFP3 pin 1 and pin 3 are for the power LED. Refer to Appendix B for detailed information on the pin assignments. If an ATX power supply is used, the system's power LED status will be as indicated as follows.

Table 2.1: ATX Power Supply LED Status

ACPI Power Mode	LED (ATX power)
System On (S0)	On
System Hibernation(S4)	Slow flashes
System Off (S5)	Off

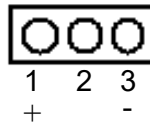

2.8.2 External Speaker (JFP2 pins 1, 4, 7, 10)

JFP2 pins 1, 4, 7, 10 connect to an external speaker. The ASMB-976 provides an onboard buzzer as an alternative. To enable the buzzer, set pins 7-10 closed.

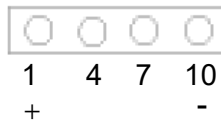

2.8.3 HDD LED Connector (JFP1 Pins 2 & 5)

You can connect an LED to connector JFP1 to indicate when the HDD is active.

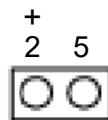

2.8.4 Reset Connector (JFP1 Pins 9 & 12)

Many computer cases offer the convenience of a reset button.

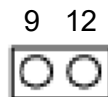

2.9 Case Open (JCASE1)

A chassis Intrusion header is located at JCASE1 on the motherboard. Attach the appropriate cable from the chassis to be informed of a chassis intrusion when the chassis is opened. The default function is disabled and Pin 1-2 is bridged by a jumper cap.

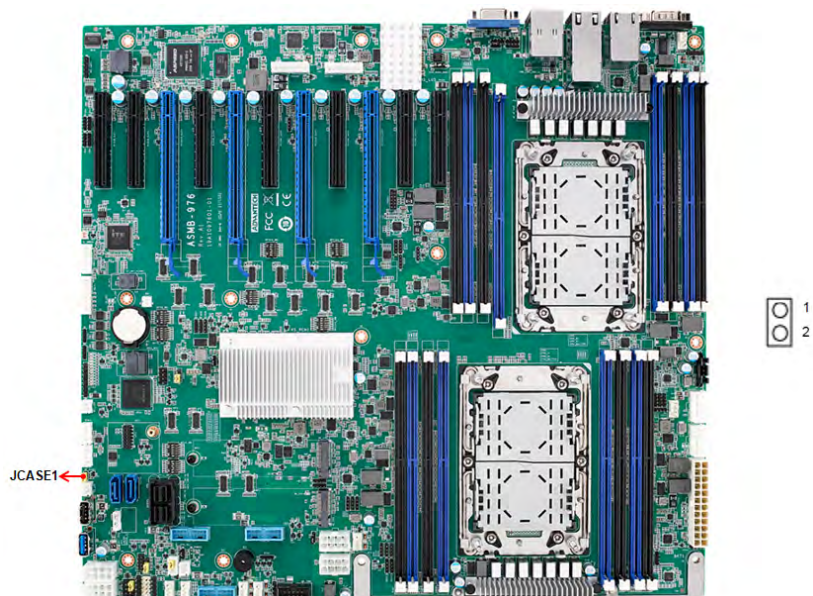

2.10 SATA SGPIO (SGPIO1)

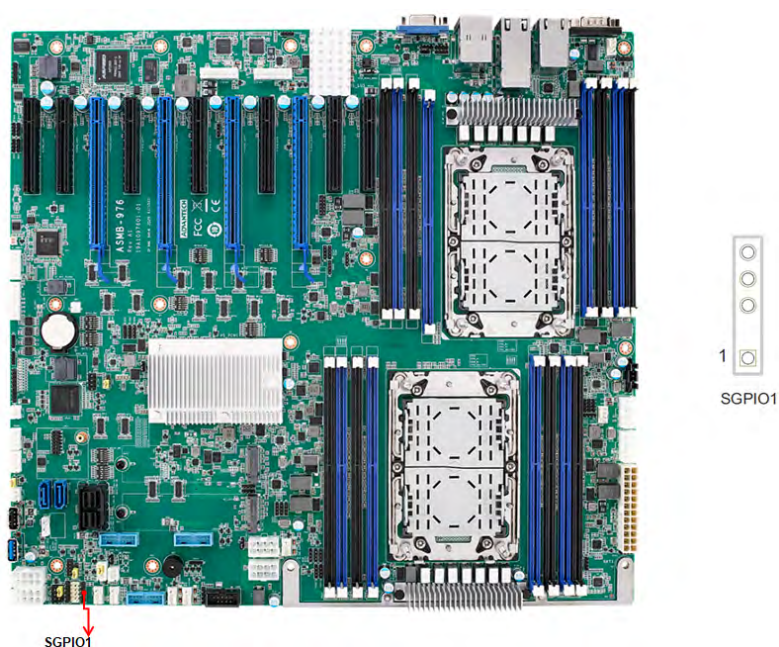

2.11 Front Panel LAN Indicator Connector (LANLED1)

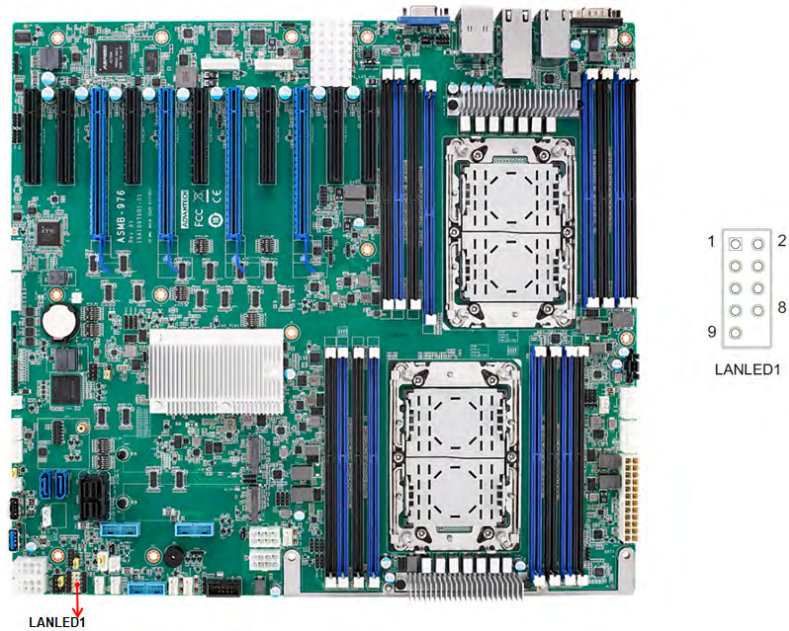

2.12 SATA and sSATA (SATA0~7, sSATA0~1)

ASMB-976 features ten serial ATA III interfaces (up to 600 MB/s) which eases cabling to hard drives with thin and long cables.

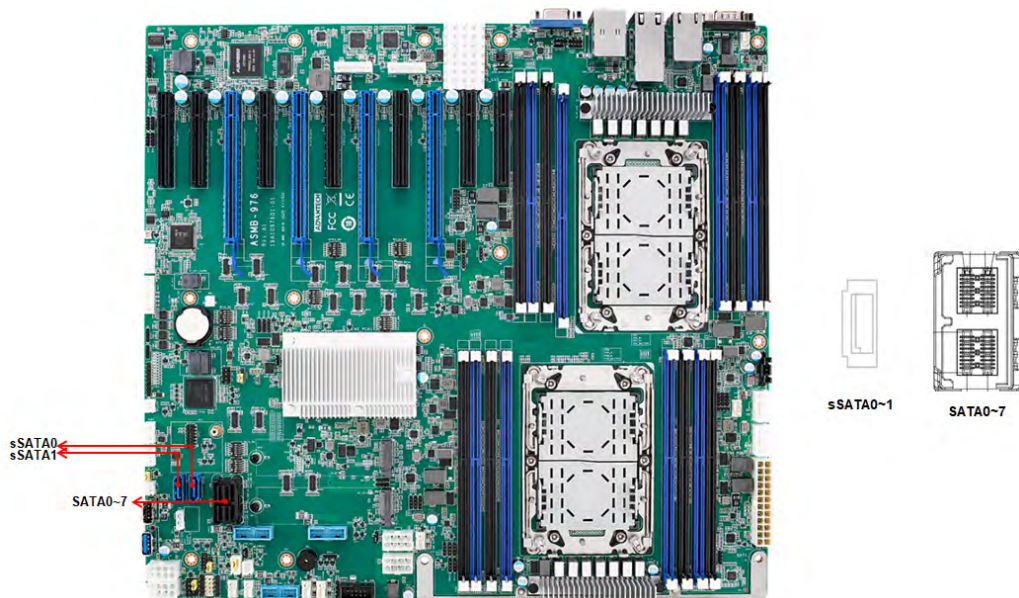

2.13 M.2 Connector (sSATA3 and PCIe gen3 and PCIe gen4)

The M.2 2280 connectors support SATA and PCIe devices.

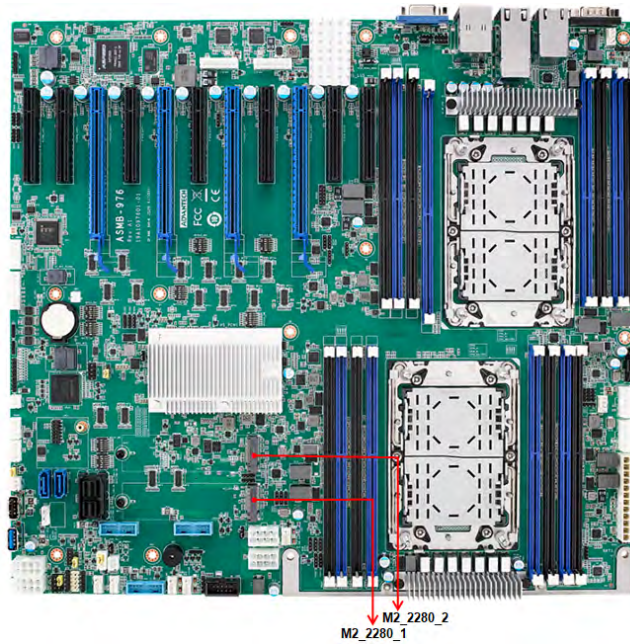

2.14 PCIe Expansion Slots

The ASMB-976 provides nine expansion slots that can support four double-deck cards, one PCIe x 8 card and one PCIe x4 card.

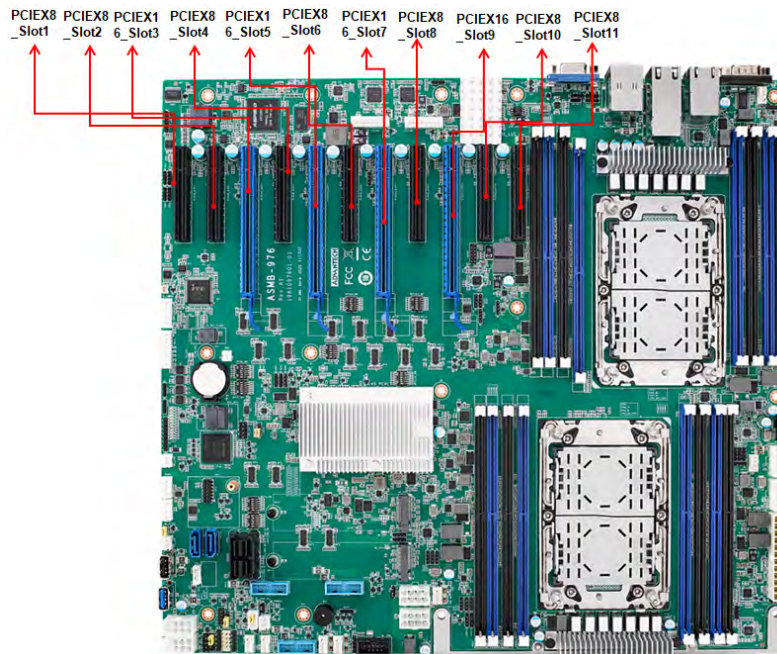

	Slot Length	Link	PCI-E Generation	PCIe link provide from
SLOT1	PCIE x8	PCIE x8	4	CPU0
SLOT2	PCIE x8	PCIE x8	4	CPU1
SLOT3	PCIE x16	PCIE x16	4	CPU0
SLOT4	PCIE x8	PCIE x8	4	CPU1
SLOT5	PCIE x16	PCIE x16	4	CPU0
SLOT6	PCIE x8	PCIE x8	4	CPU0
SLOT7	PCIE x16	PCIE x16	4	CPU1
SLOT8	PCIE x8	PCIE x8	4	CPU0
SLOT9	PCIE x16	PCIE x16	4	CPU1
SLOT10	PCIE x8	PCIE x8	4	CPU1
SLOT11	PCIE x8	PCIE x8	4	CPU1

2.15 Auxiliary Power Connector (ATXPWR1/ ATX12V1/ATX12V/ATX12V3/ATX12V4)

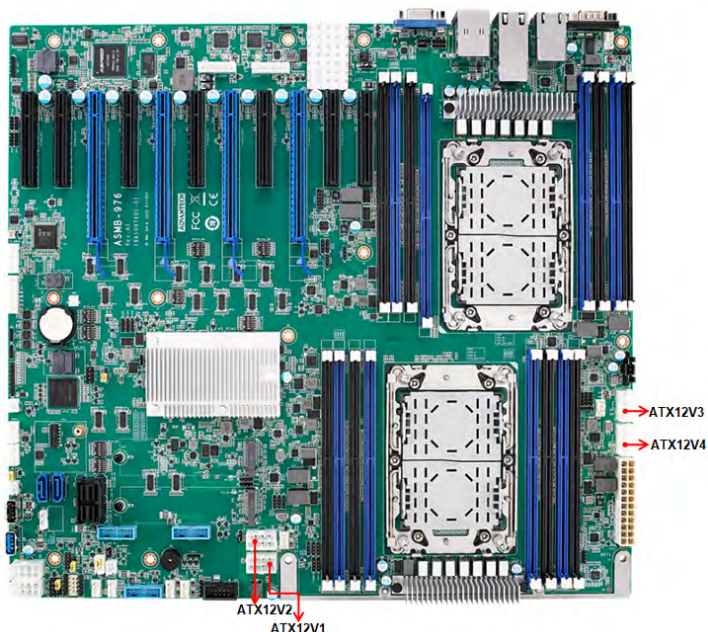

- Note!**
1. Please use a power supply which is of SSI type; minimum output should be at least 700W with 5Vsb @2.5A.
 2. ATXPWR1 & ATX12V1 & ATX12V3 should be all connected with power supply, otherwise ASMB-976 will not boot up normally.



2.16 HD Audio Interface Connector (HDAUD1)

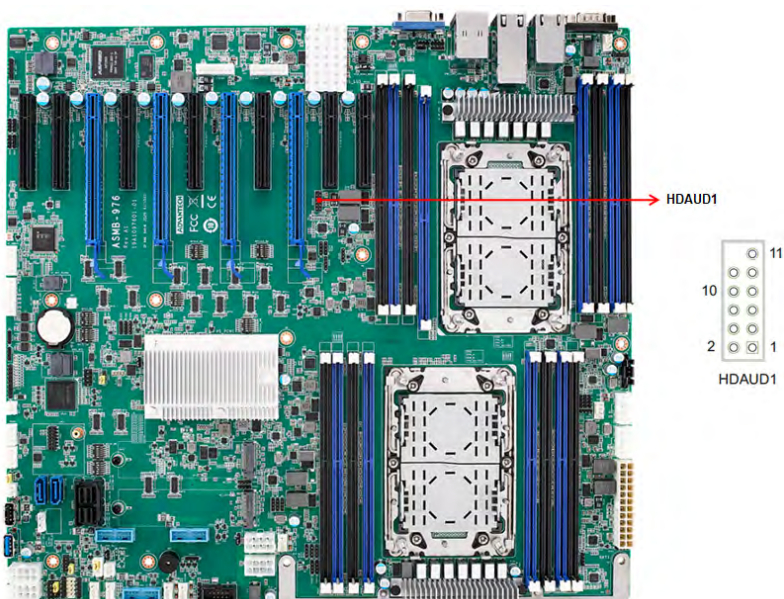

2.17 LPC Connector (LPC1)

ASMB-976 has one LPC connector that can be used to install Advantech's TPM Module (P/N: PCA-TPM-00A1E, PCA-TPM-00B1E) for security management.

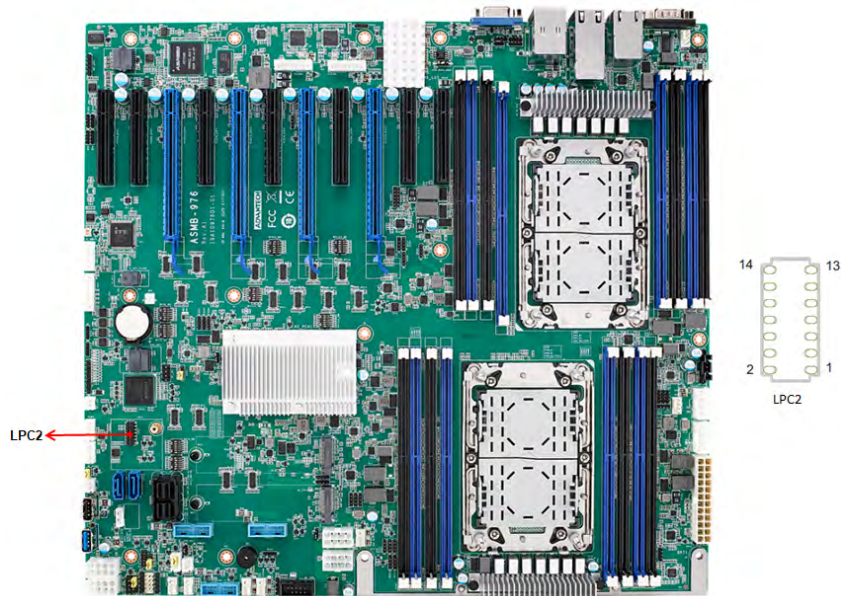

2.18 CMOS Clear and ME Update Connector (JCMOS1, JME1)

Setting jumper from pin 1-2 to pin 2-3, then back to pin 1-2 to reset CMOS data and enable ME update.

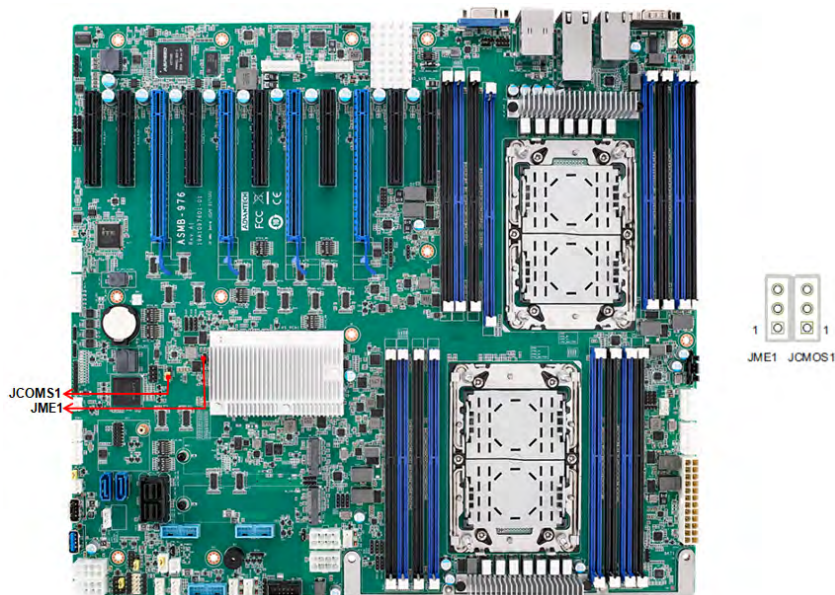

2.19 PMBUS Connector (PMBUS1)

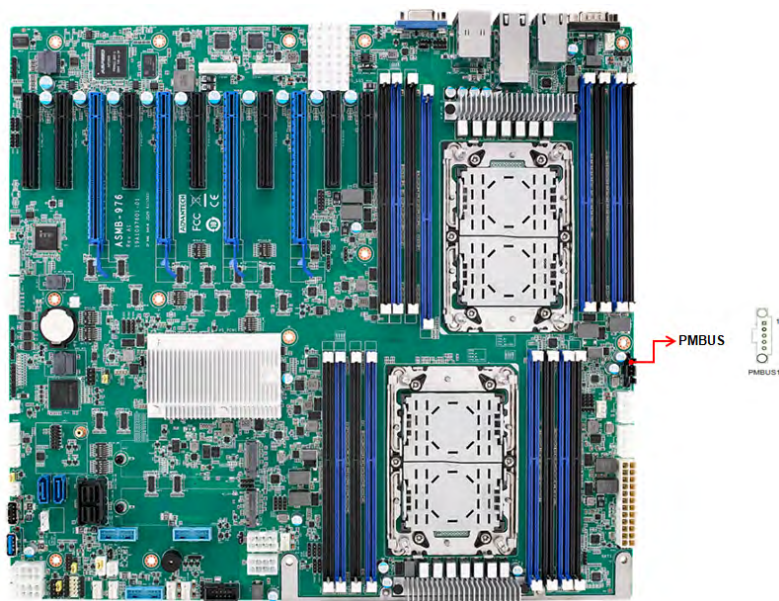

2.20 Front Panel SMBUS Connector (SMBUS1)

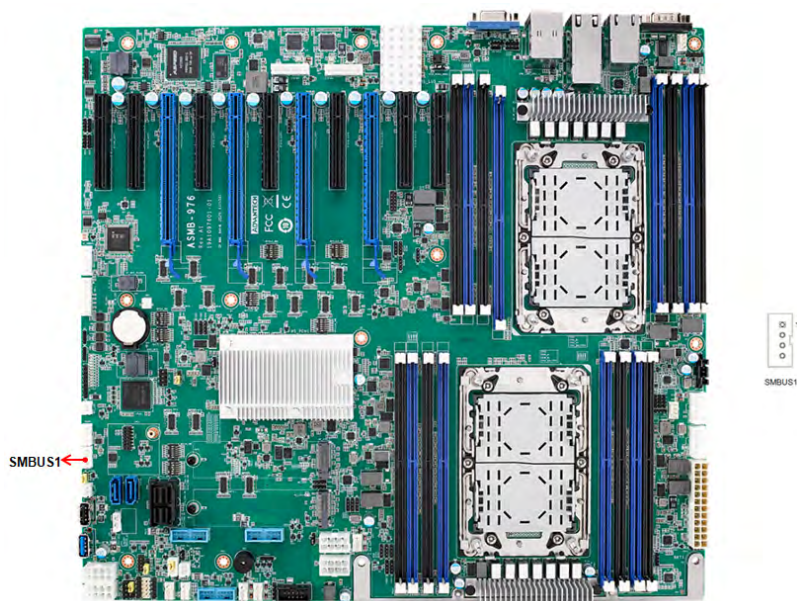

2.21 BMC IC Socket (CN2)

Enabling IPMI feature through CN2. The BMC IC socket has already been pre-installed on ASMB-976T2 sku.

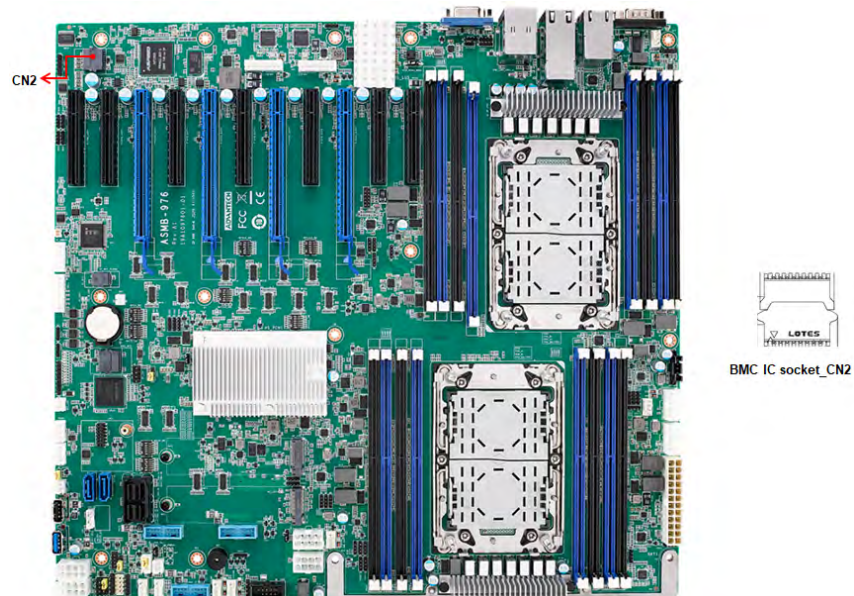

2.22 VOLT1 Connector (VOLT1)

VOLT1 connects to the alarm board on the Advantech chassis. These alarm boards give warnings if a power supply or fan fails, if the chassis overheats, or if the back-plane malfunctions.

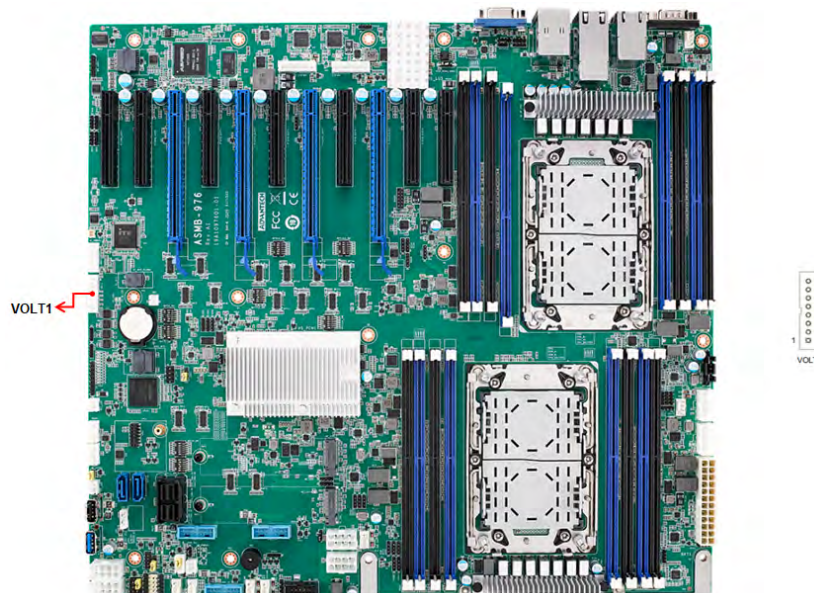

2.23 GPIO Connector (GPIO1)

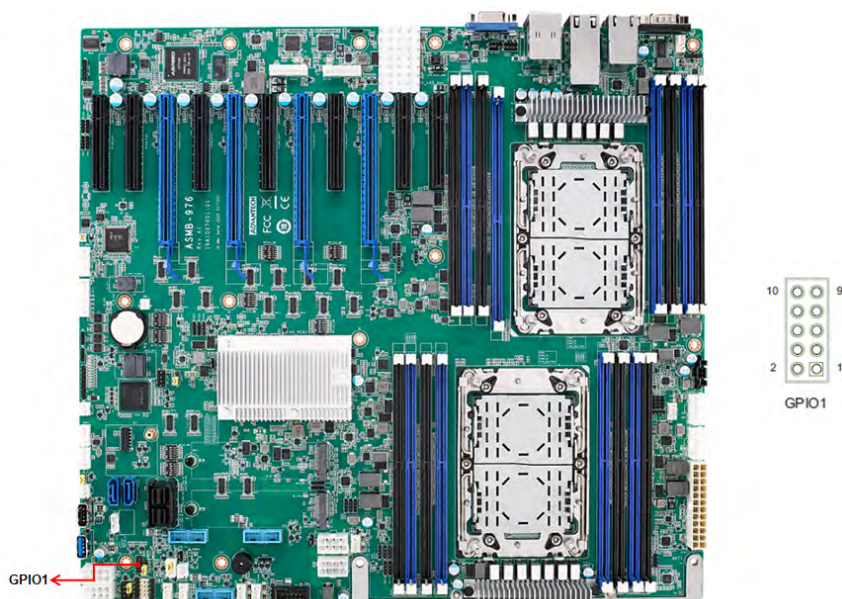

2.24 Intel Virtual RAID (VROC1)

Intel VROC license key of VMD allows NVMe SSDs to connect via PCIe and directly manages the CPU for better RAID performance. Enable NVMe SSD RAID, hot-plug and LED management features via VROC connector.

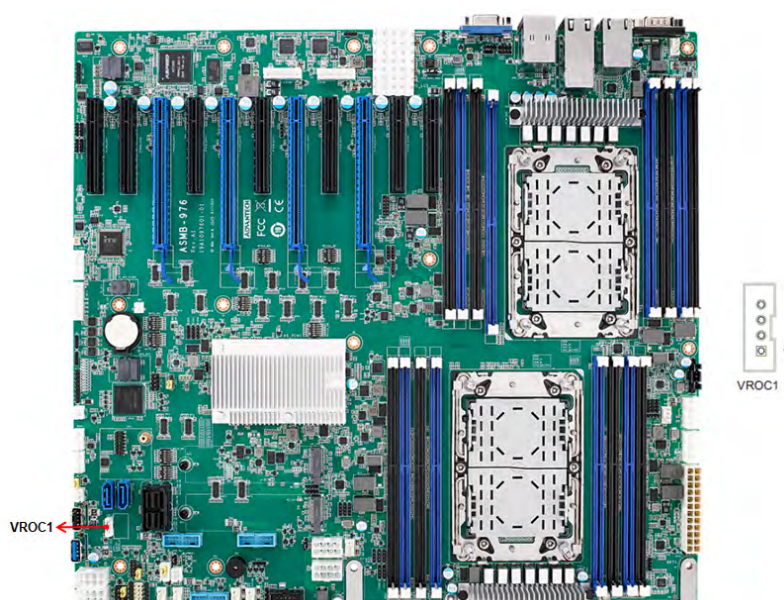

2.25 NVMe RAID LED Control (PEHP1)

Connect to storage chassis to enable NVMe RAID LED control feature.

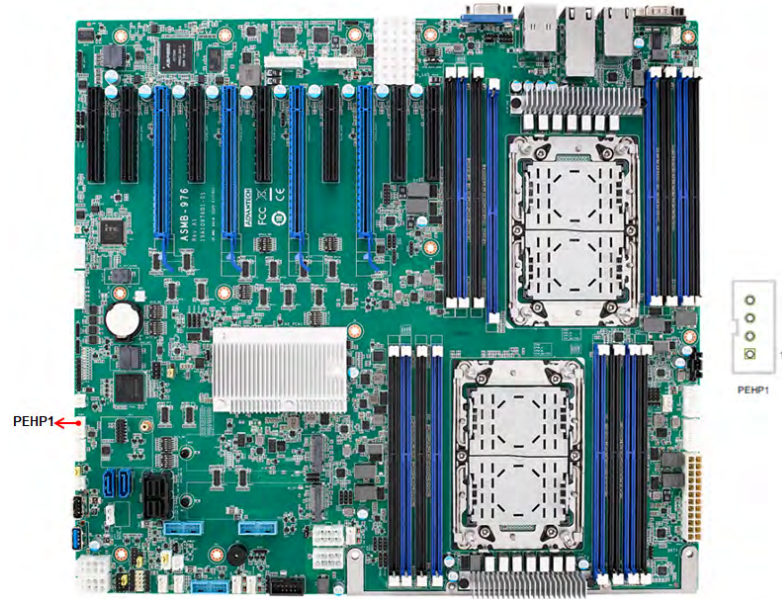

Chapter 3

AMI BIOS

3.1 Introduction

With the AMI BIOS Setup program, you can modify BIOS settings and control the special features of your computer. The Setup program uses a number of menus for making changes and turning the special features on or off. This chapter describes the basic navigation of the ASMB-976 setup screens.



AMI's BIOS ROM has a built-in Setup program that allows users to modify the basic system configuration. This type of information is stored in battery-backed up CMOS so it retains the Setup information when the power is turned off.

Note! *The BIOS setup screens shown in this chapter are for reference only, they may not exactly match what you see on your display devices.*



3.2 BIOS Setup

3.2.1 Main Menu

Press during bootup to enter AMI BIOS CMOS Setup Utility; the Main Menu will appear on the screen. Use arrow keys to select among the items and press <Enter> to accept or enter the sub-menu.



The Main BIOS setup screen has two main frames. The left frame displays all the options that can be configured. Grayed-out options cannot be configured; options in blue can be. The right frame displays the key legend. Above the key legend is an area reserved for a text message. When an option is selected in the left frame, it is highlighted in white. Often a text message will accompany it.

■ System Date/System Time

Use this option to change the system time and date. Highlight System Time or System Date using the <Arrow> keys. Enter new values through the keyboard. Press the <Tab> key or the <Arrow> keys to move between fields. The date must be entered in MM/DD/YY format. The time must be entered in HH:MM:SS format.

3.2.2 Advanced BIOS Features Setup

Select the Advanced tab from the ASMB-976 setup screen to enter the Advanced BIOS setup screen. You can select any of the items in the left frame of the screen, such as CPU configuration, to go to the sub menu for that item. You can display an Advanced BIOS Setup option by highlighting it using the <Arrow> keys. All Advanced BIOS Setup options are described in this section. The Advanced BIOS Setup screens are shown below. The sub menus are described on the following pages.

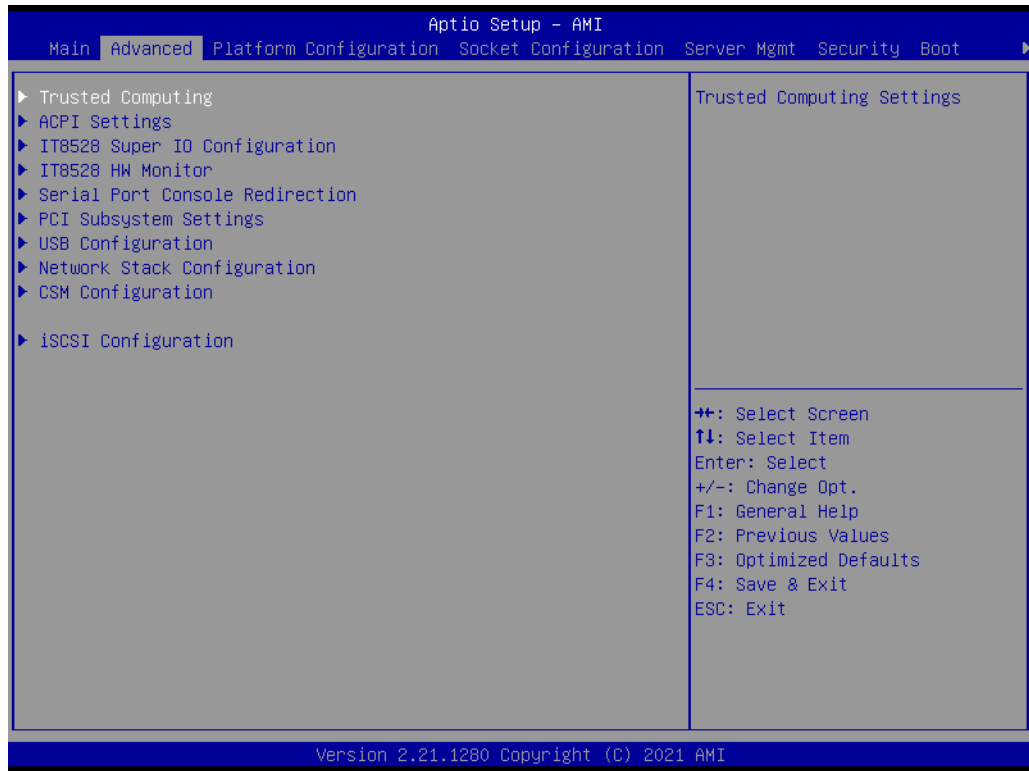

3.2.2.1 Trusted Computing



- **Security Device Support**
Enables or disables BIOS support for security device.
Purchase Advantech LPC TPM module to use TPM function. (P/N: PCA-TPM-00A1E/PCA-TPM-00B1E.)

3.2.2.2 ACPI Settings

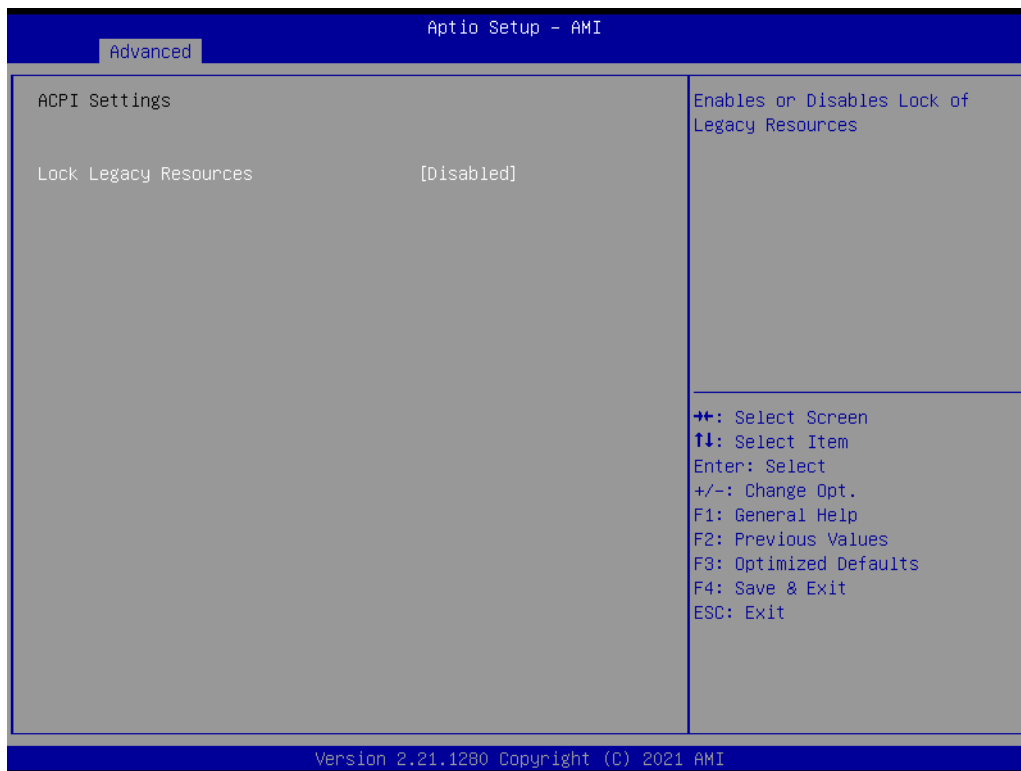

- **Lock Legacy Resources**
Enable or disable lock legacy resources feature.

3.2.2.3 IT8528 EC Super IO Configuration



Serial Port 1 Configuration

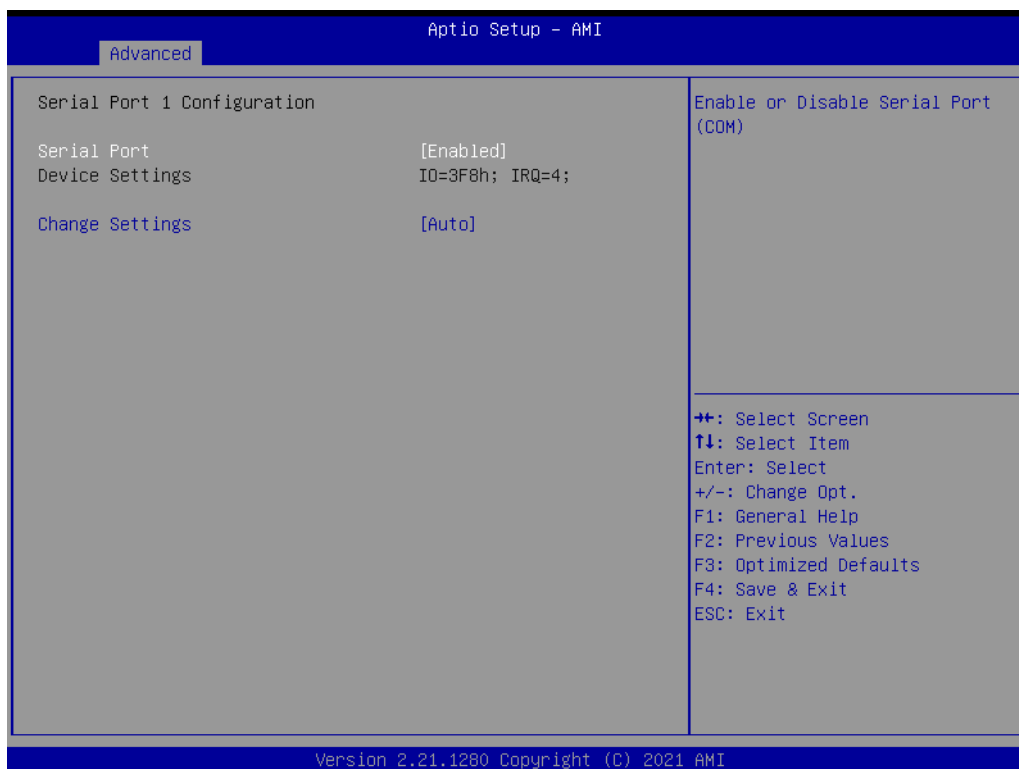

- **Serial Port**
Enable or disable serial port 1.
- **Change Settings**
To select an optimal setting for serial port 1.

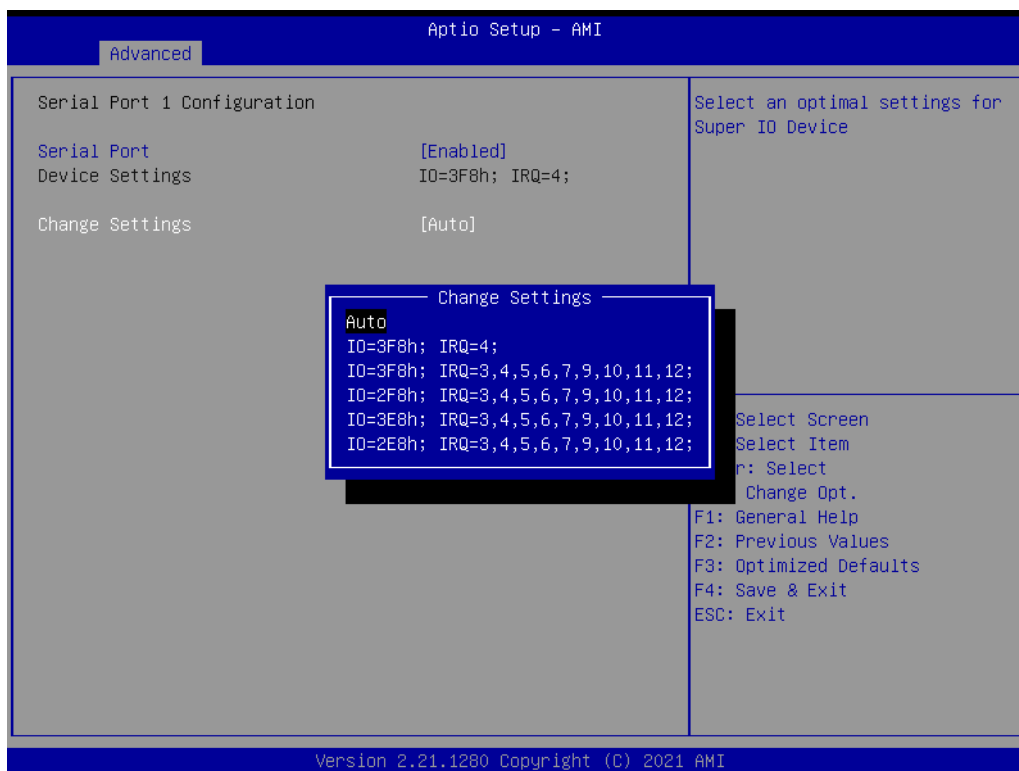

■ Serial Port 2 Configuration

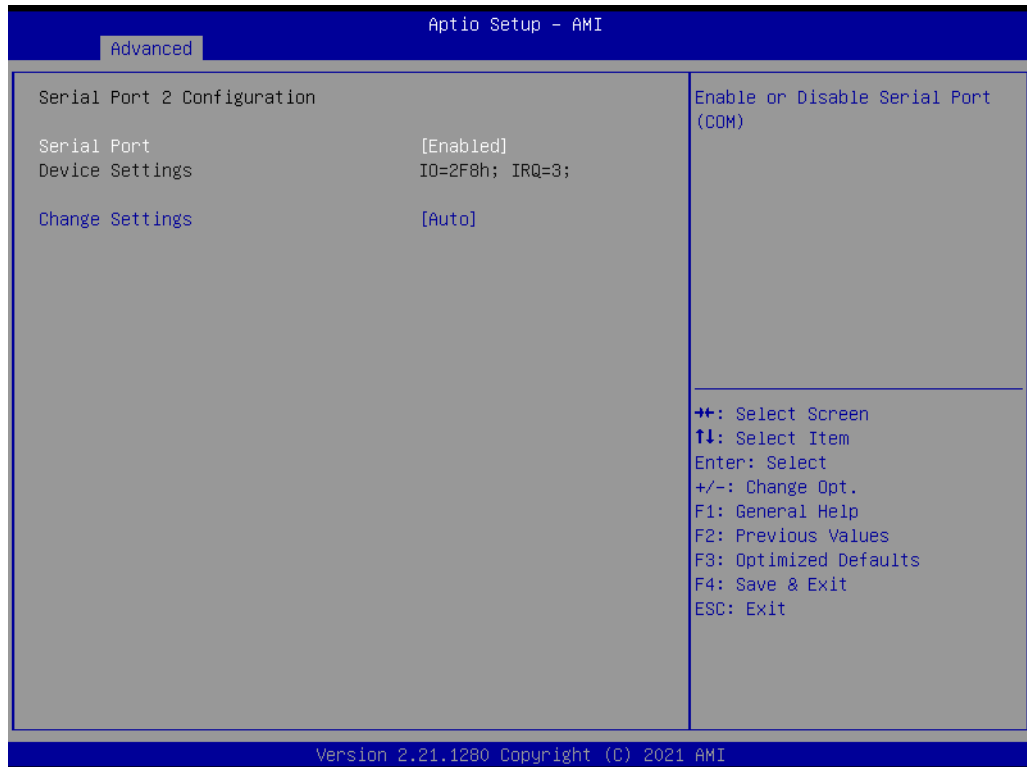

- **Serial Port**
Enable or disable serial Port 2.
- **Change Settings**
To select an optimal setting for serial port 2.

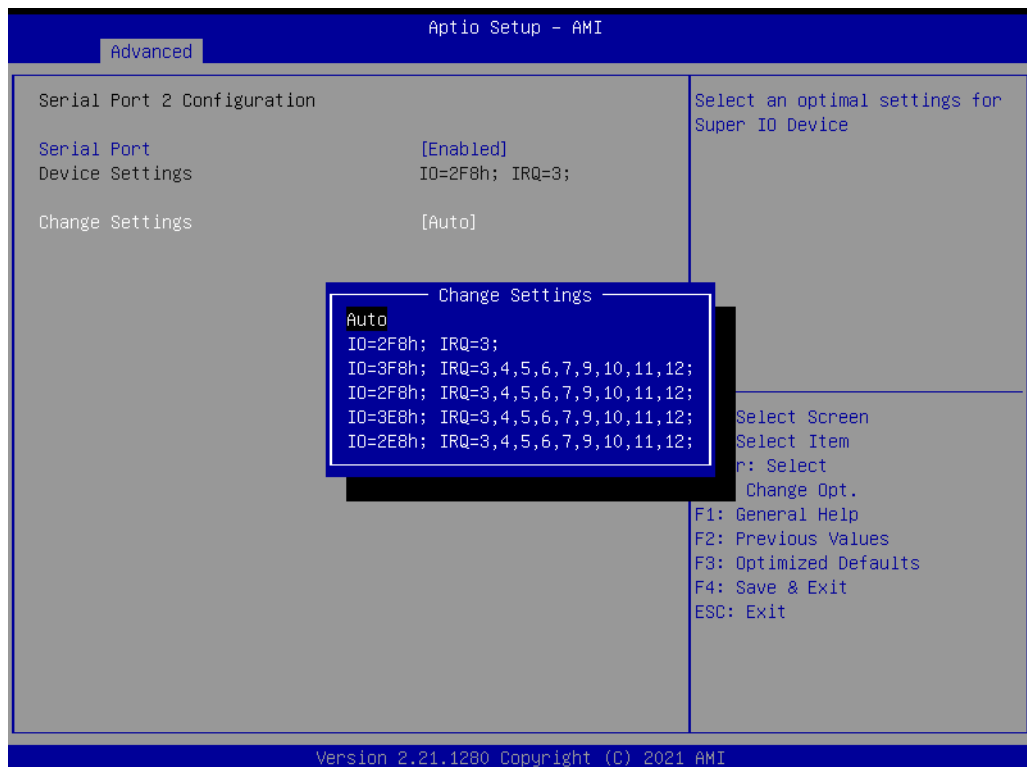

3.2.2.4 IT8528 HW Monitor

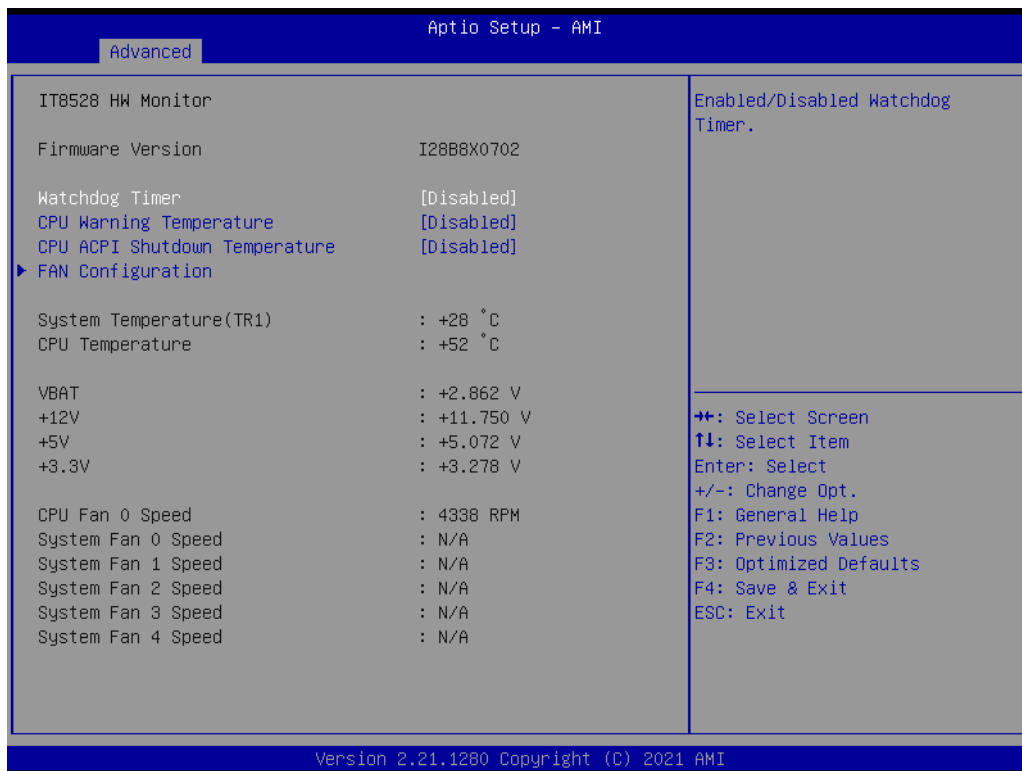

- **Watchdog Timer**
Enable or disable the watchdog timer function.
- **CPU ACPI Shutdown Temperature**
Enable or disable the ACPI shutdown temperature threshold. When the system reaches the shutdown temperature, it will be automatically shut down by ACPI OS to protect the system from overheat damage.
- **CPU Warning Temperature**
Enable or disable the CPU warning temperature threshold. When the system reaches the warning temperature, the speaker will beep.
- **Fan Configuration**
The default of CPU/System FAN is Smart FAN mode and the BIOS will automatically control the FAN speed by CPU temperature.
When set to manual mode, fan duty setting can be changed; the range is from 30%~100%, default setting is 50%.

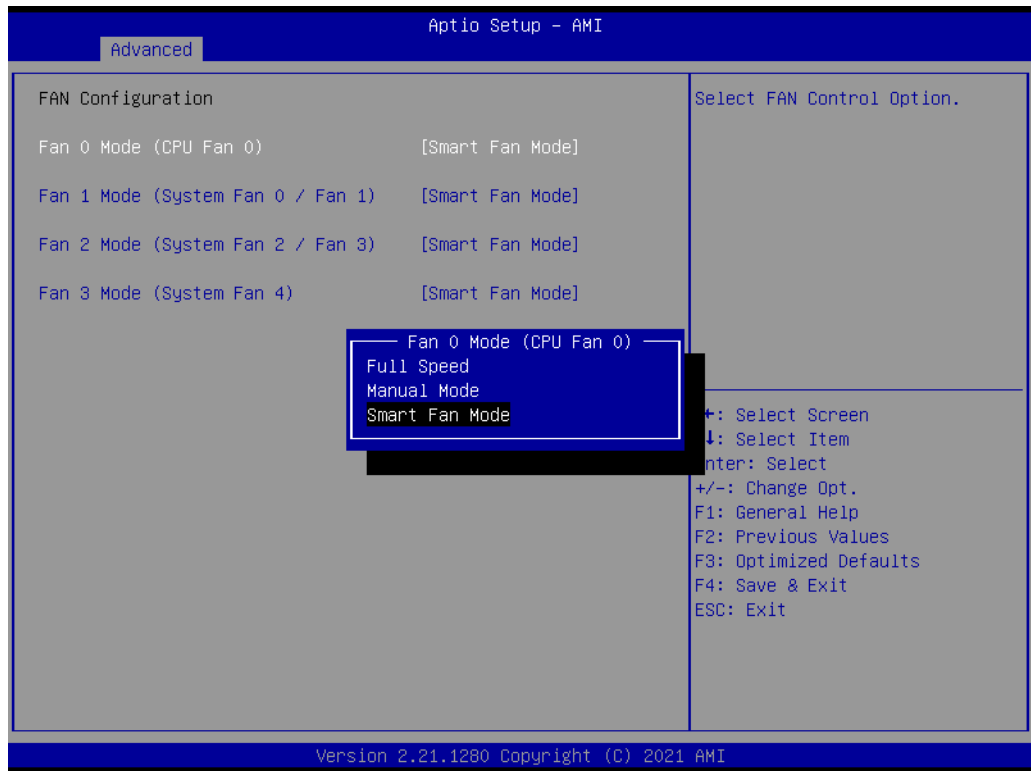

3.2.2.5 Serial Port Console Redirection

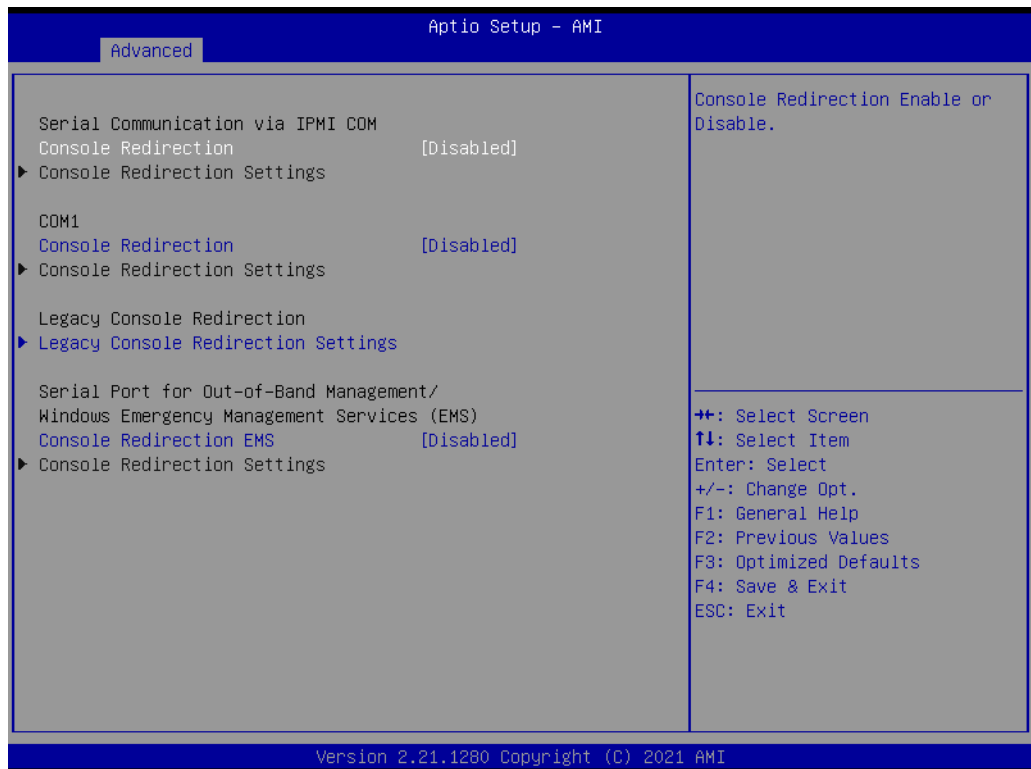

■ Console Redirection Settings



- **Terminal Type**
Select a terminal type to be used for console redirection.
Options available: VT100/VT100+/ANSI/VT-UTF8.
- **Bits Per Second**
Select the baud rate for console redirection.
Options available: 9600/19200/57600/115200.
- **Data Bits**
- **Parity**
A parity bit can be sent with the data bits to detect some transmission errors.
Even: parity bit is 0 if the number of 1's in the data bits is even.
Odd: parity bit is 0 if number of 1's the data bits is odd.
Mark: parity bit is always 1. Space: Parity bit is always 0.
Mark and Space Parity do not allow for error detection.
Options available: None/Even/Odd/Mark/Space.
- **Stop Bits**
Stop bits indicate the end of a serial data packet. (A start bit indicates the beginning). The standard setting is 1 stop bit. Communication with slow devices may require more than 1 stop bit.
Options available: 1/2.
- **Flow Control**
Flow control can prevent data loss from buffer overflow. When sending data, if the receiving buffers are full, a 'stop' signal can be sent to stop the data flow. Once the buffers are empty, a 'start' signal can be sent to re-start the flow. Hardware flow control uses two wires to send start/stop signals.
Options available: None/Hardware RTS/CTS.
- **VT-UTF8 Combo Key Support**
Enable VT-UTF8 combination key support for ANSI/VT100 terminals.

- **Recorder Mode**

When this mode enabled, only text will be send. This is to capture Terminal data.

Options available: Enabled/Disabled.

- **Resolution 100x31**

Enables or disables extended terminal resolution.

- **Putty Keypad**

Select function key and keypad on putty.

- **Legacy Console Redirection Settings**

Select a COM port to display redirection of Legacy OS and Legacy OPROM Messages.

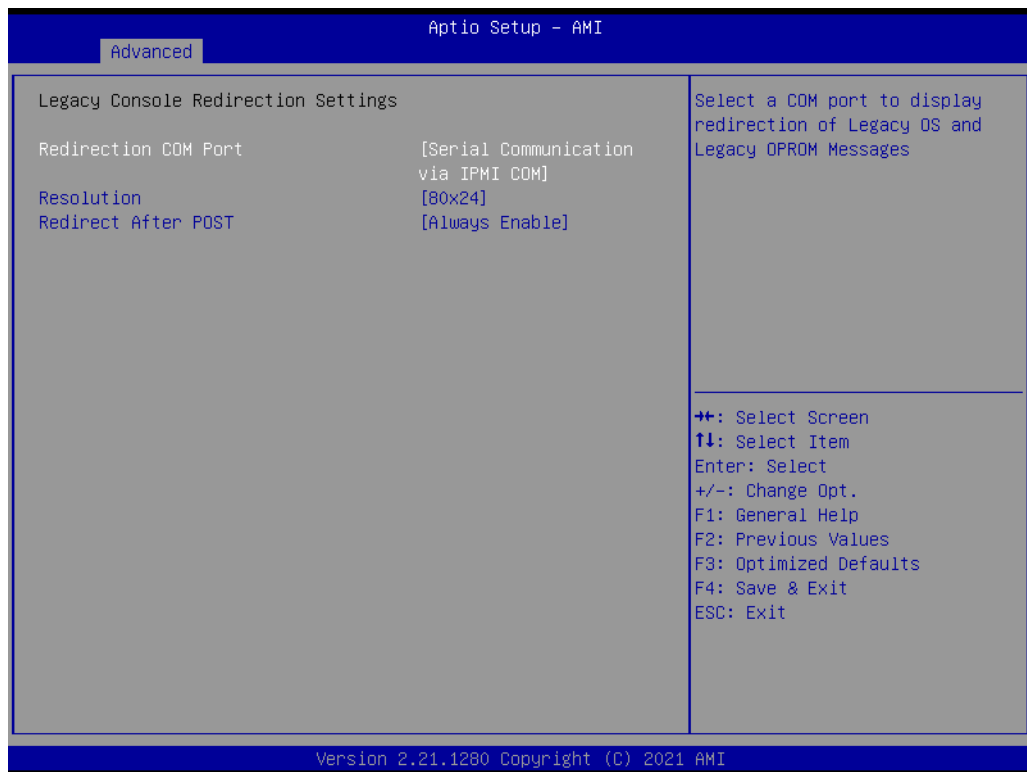

3.2.2.6 PCI Subsystem Settings



- Above 4G Decoding**
 Enable or disable 64-bit capability. Devices to be decoded in above 4G address space (only if the system supports 64-bit PCI decoding).

Note! *Some graphic or GPU cards need to enable 4G Decoding.*



3.2.2.7 USB Configuration

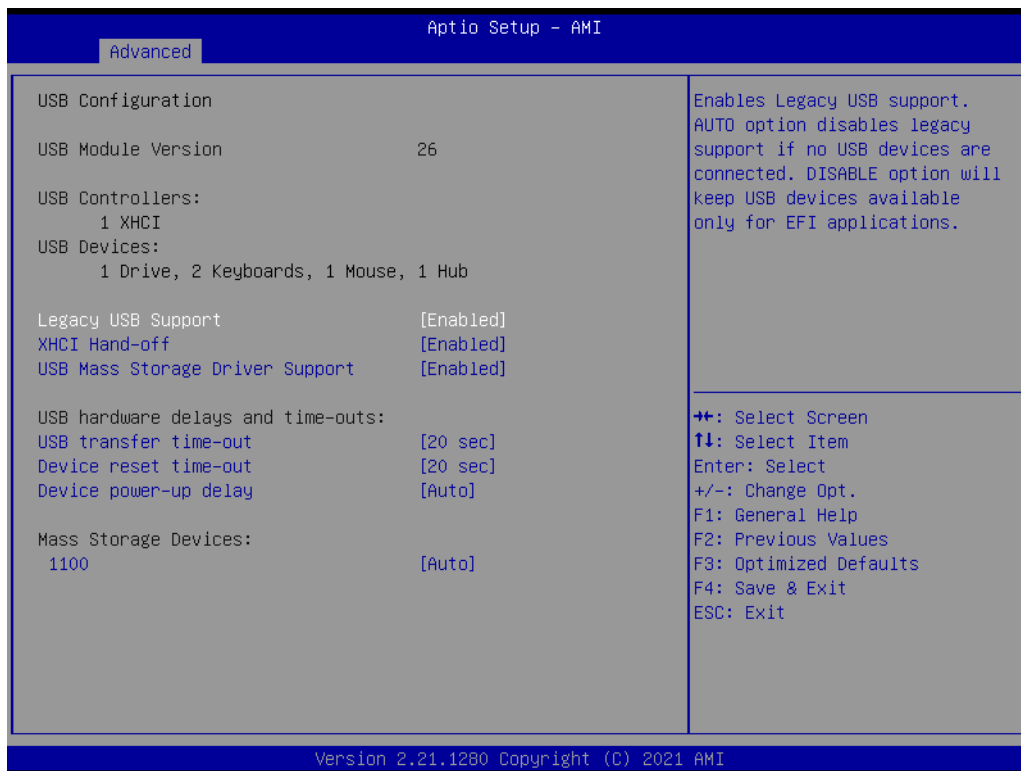

- **Legacy USB Support**
This is for supporting USB device under a legacy OS such as DOS. When choosing “Auto”, the system will automatically detect if any USB device is plugged into the computer and enable USB legacy mode when a USB device is plugged, or disable USB legacy mode when no USB device is attached.
- **XHCI Hand-off**
This is a workaround for OS without XHCI hand-off support. The XHCI ownership change should be claimed by XHCI driver.
- **USB Mass Storage Driver Support**
Enable or disable USB mass storage driver support.
- **USB Transfer Time-out**
Selects the USB transfer time-out value. [1,5,10,20sec]

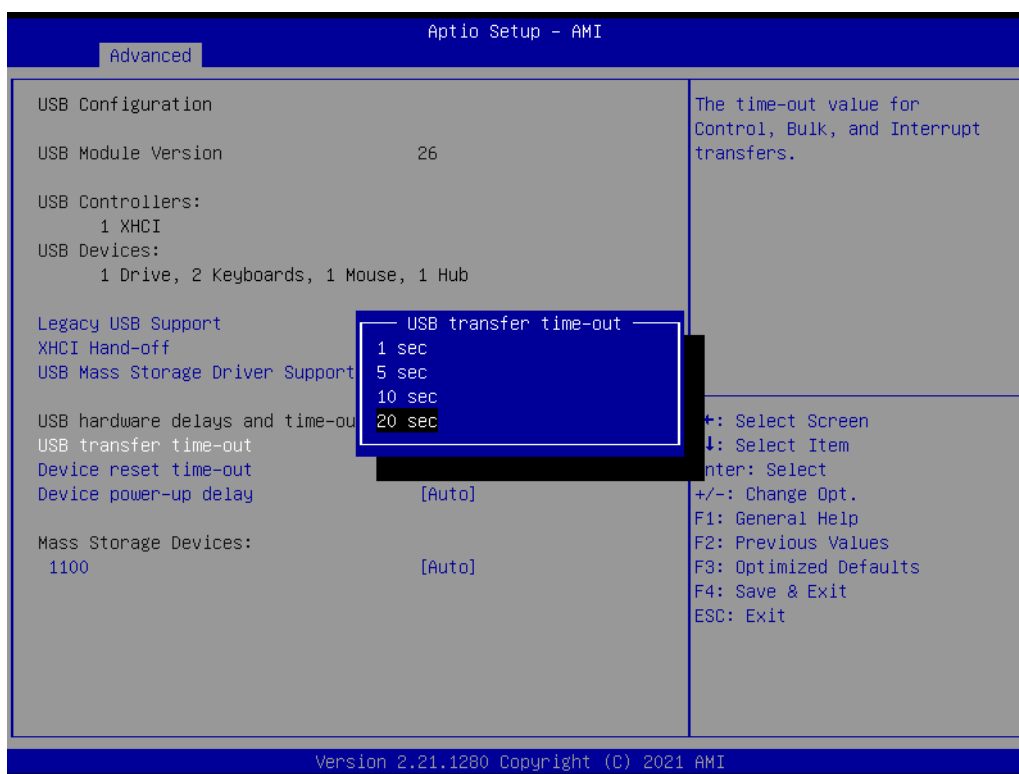

■ Device Reset Time-out

Selects the USB device reset time-out value. [10,20,30,40 sec]

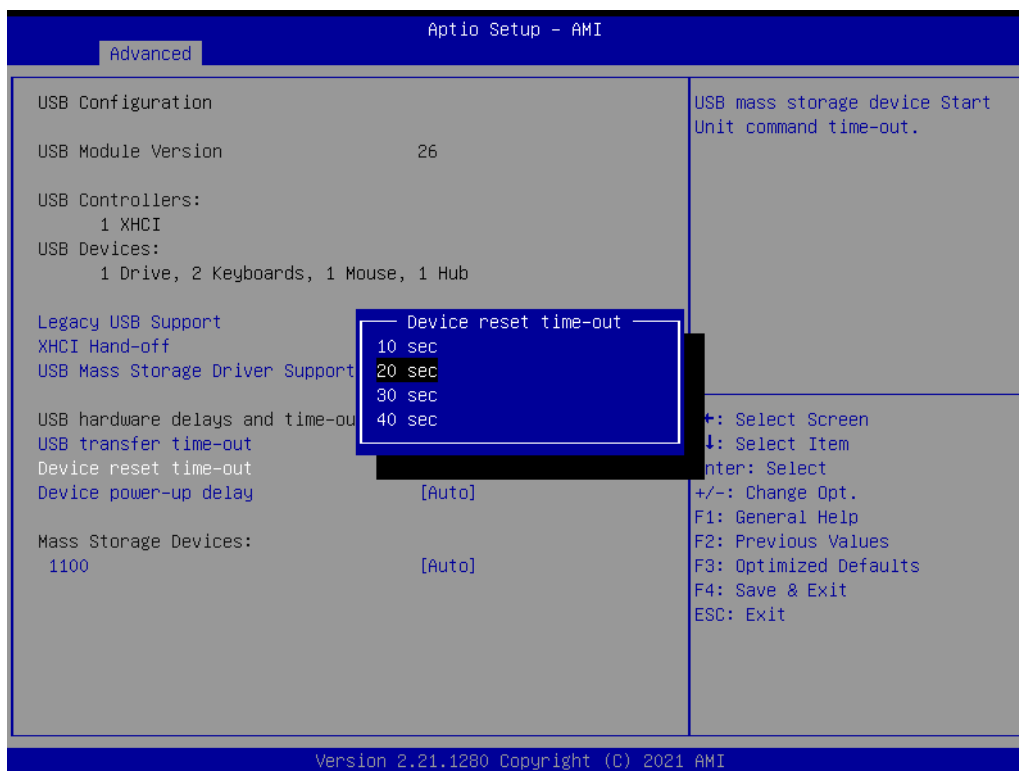

■ Device Power-up Delay

This item appears only when Device power-up delay item is set to [manual].

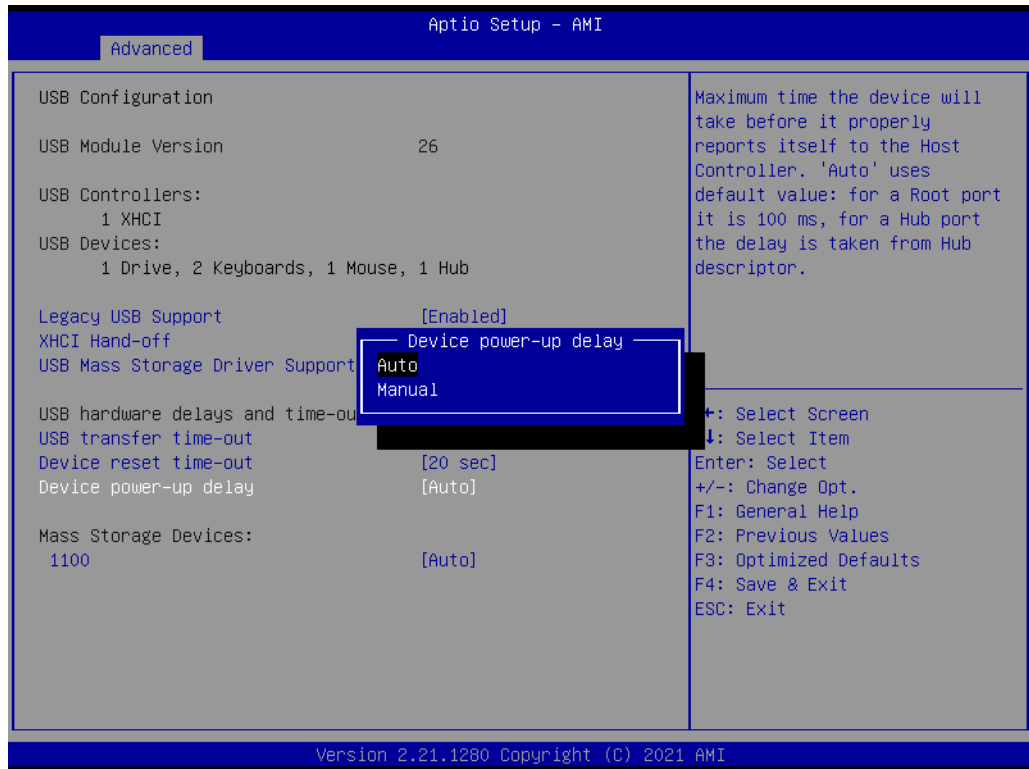

■ **Mass Storage Devices**

Default is “Auto” to enumerate mass storage devices according to media format.

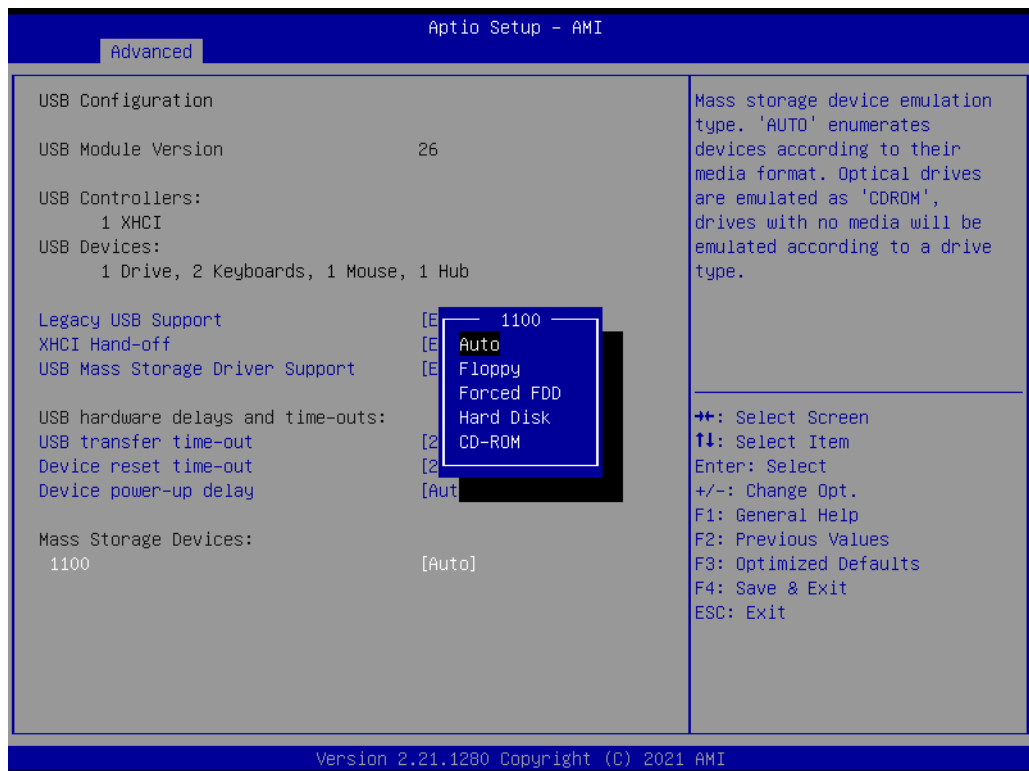

3.2.2.8 Network Stack Configuration

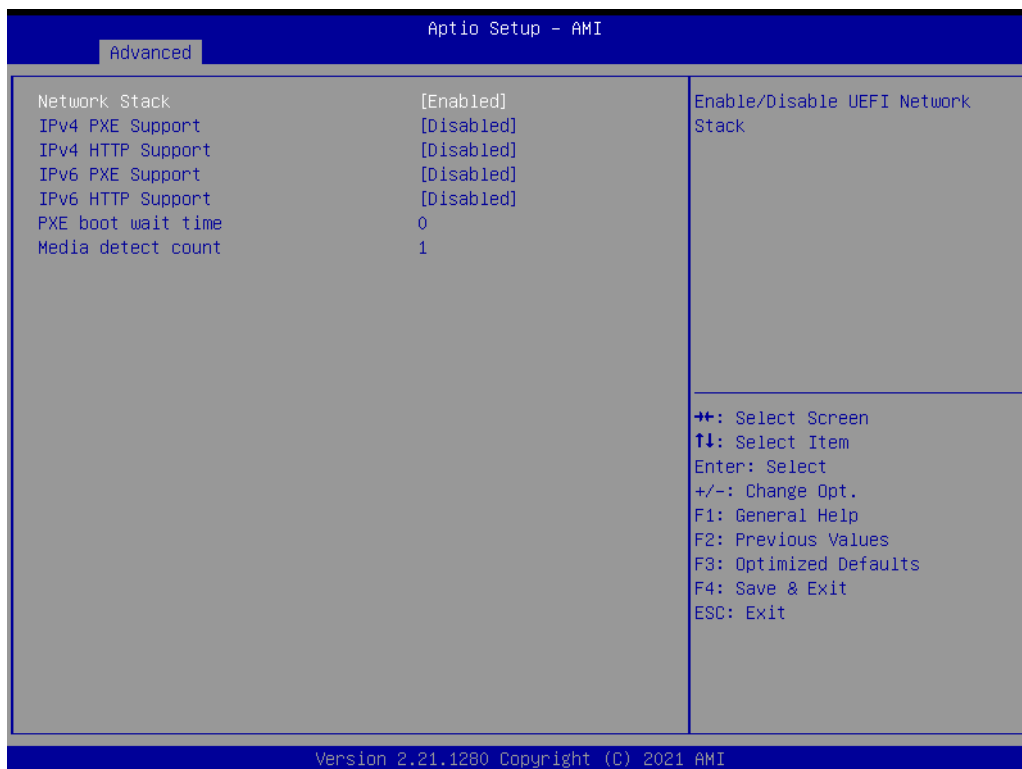

Enable or disable UEFI network stack function.

3.2.2.9 CSM Configuration

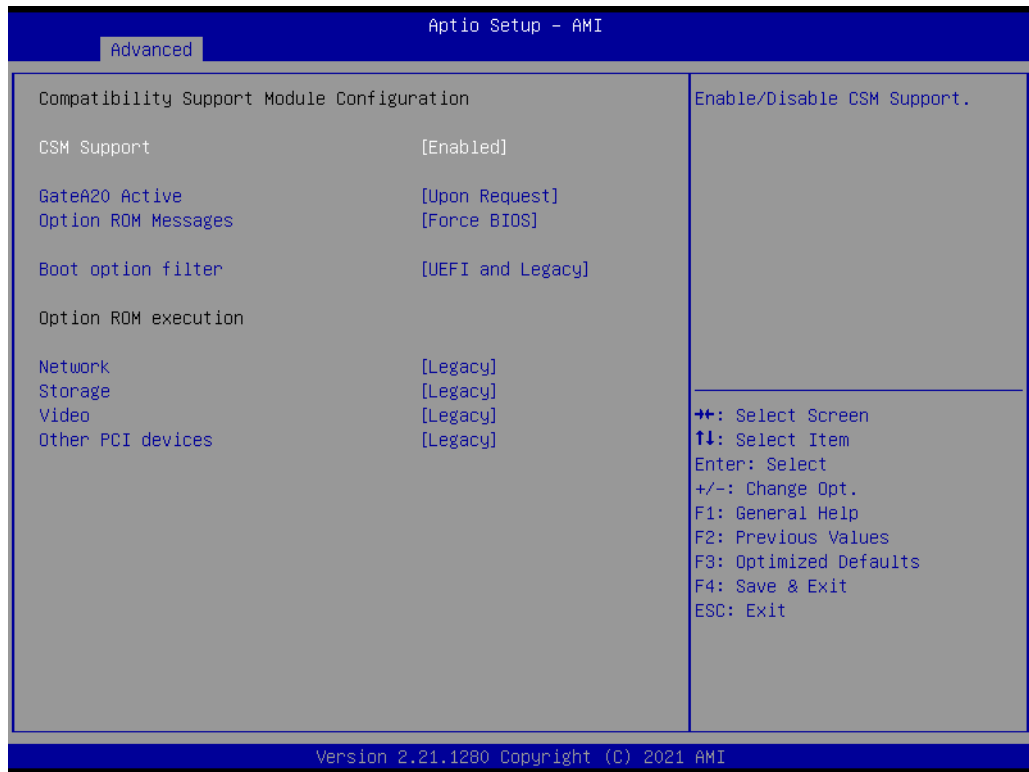

■ CSM Support

Enables or Disables UEFI CSM (Compatibility Support Module) to support a legacy PC boot process. Default is Disabled.

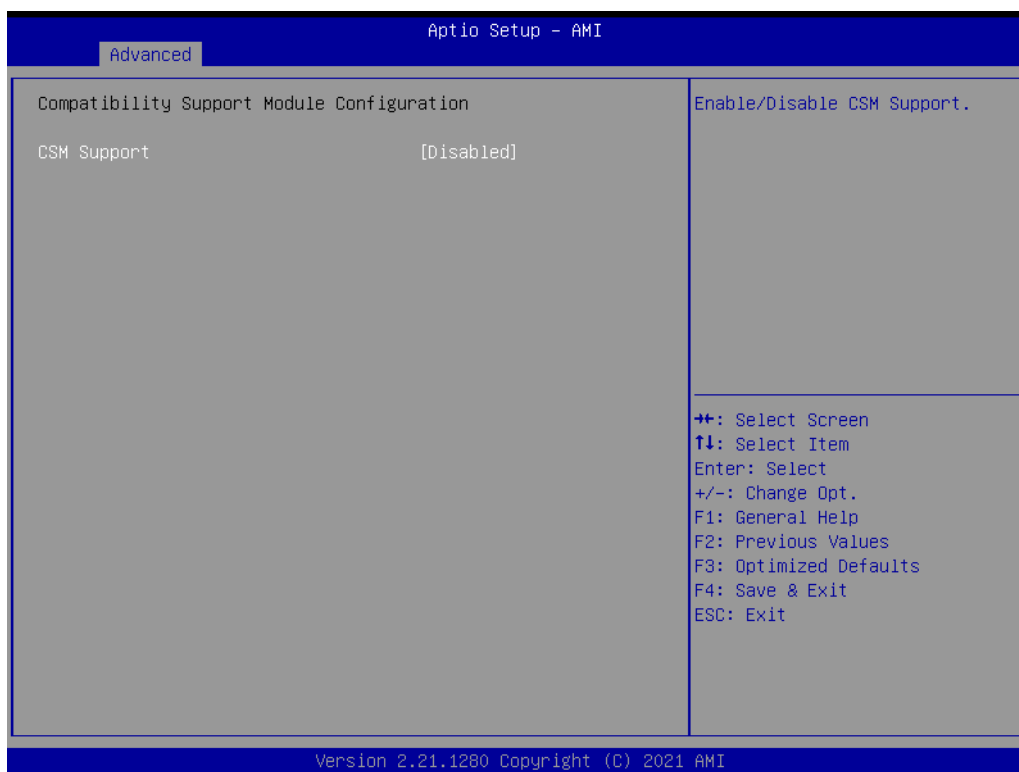

■ GateA20 Active

This item is useful when RT code is executed above 1MB. When it's set as "Upon Request", GA20 can be disabled using BIOS services. When it's set as "Always", it does not allow disabling of GA20.

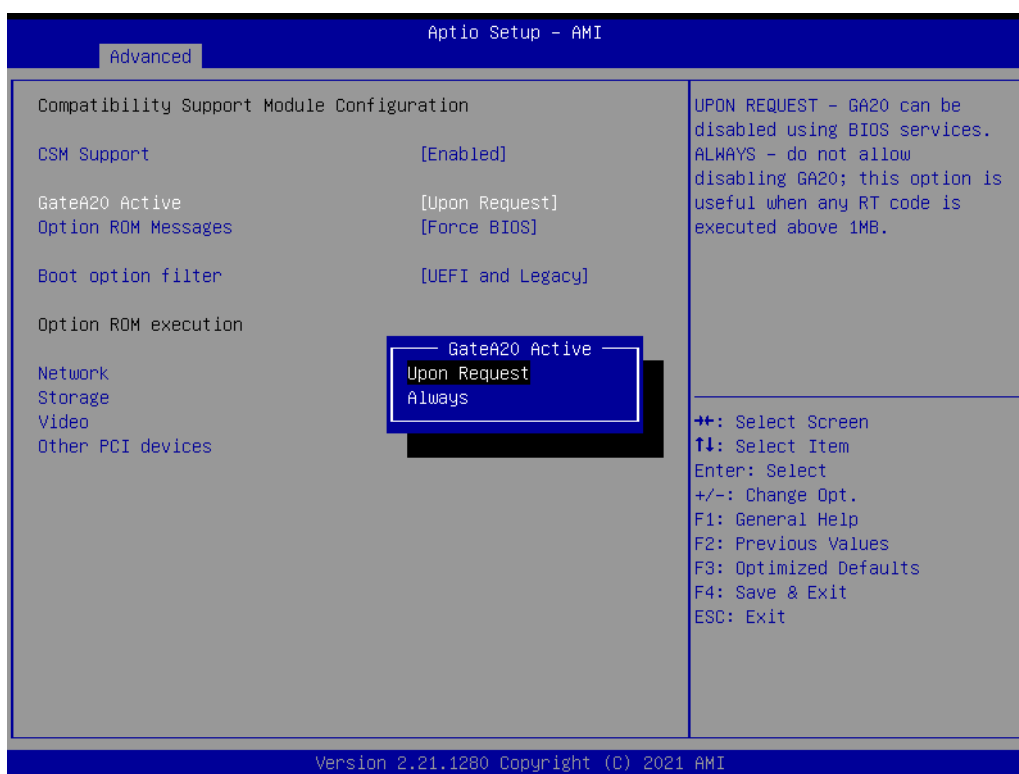

■ **Option ROM Messages**

To “Force BIOS or keep current” to set the display mode for Option ROM.

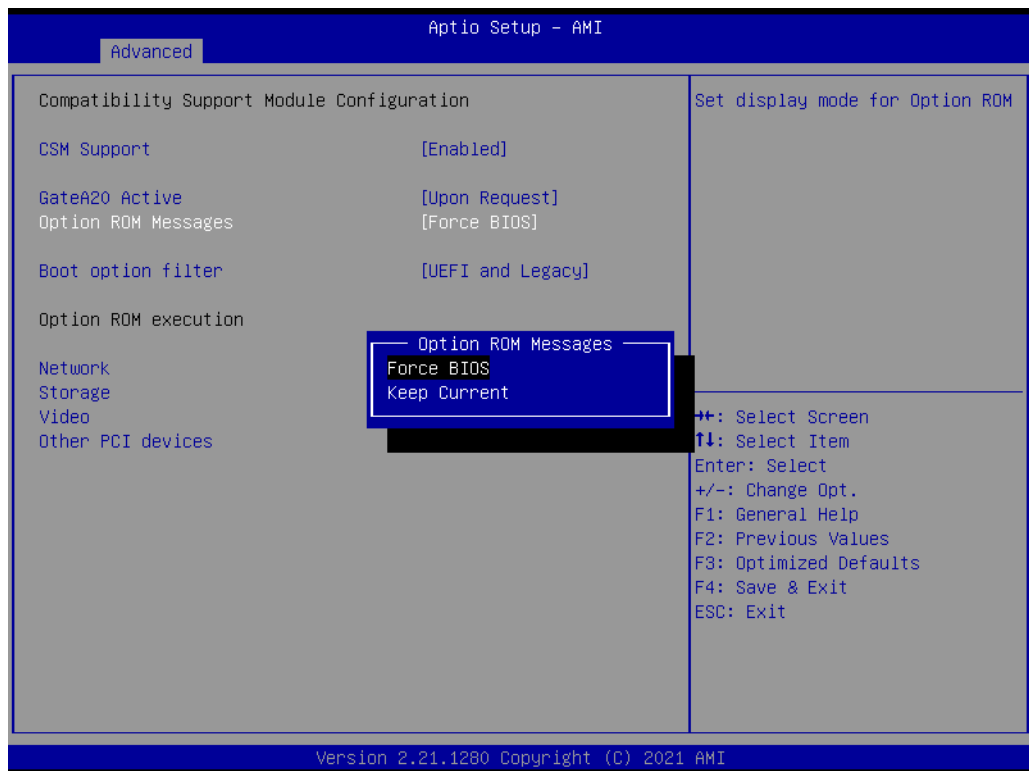

■ **Boot Option Filter**

Change UEFI/legacy ROM priority for boot option.

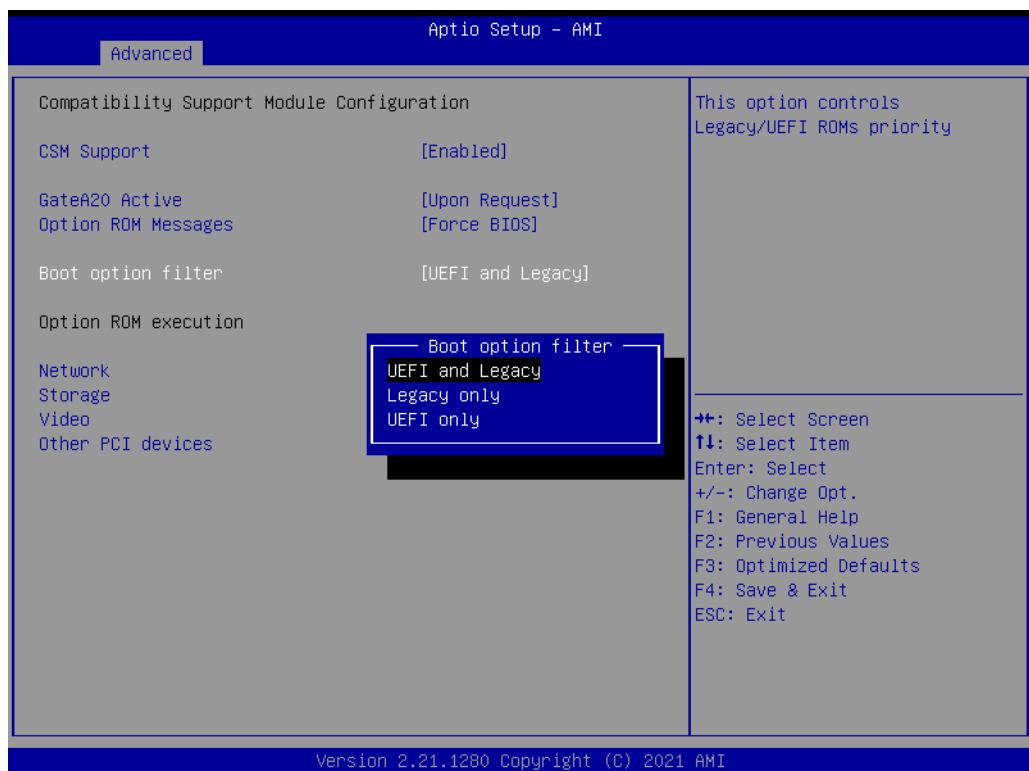

- Network**
 Control the execution of UEFI and legacy PXE OpROM.

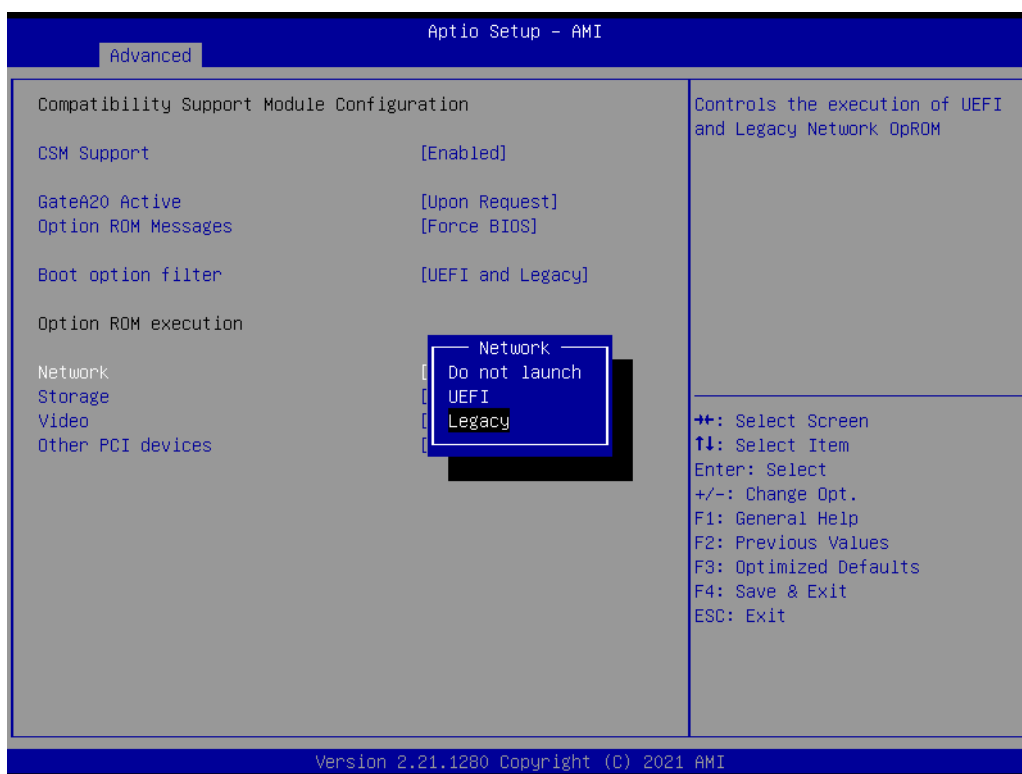

- Storage**
 Control the execution of UEFI and legacy storage OpROM.

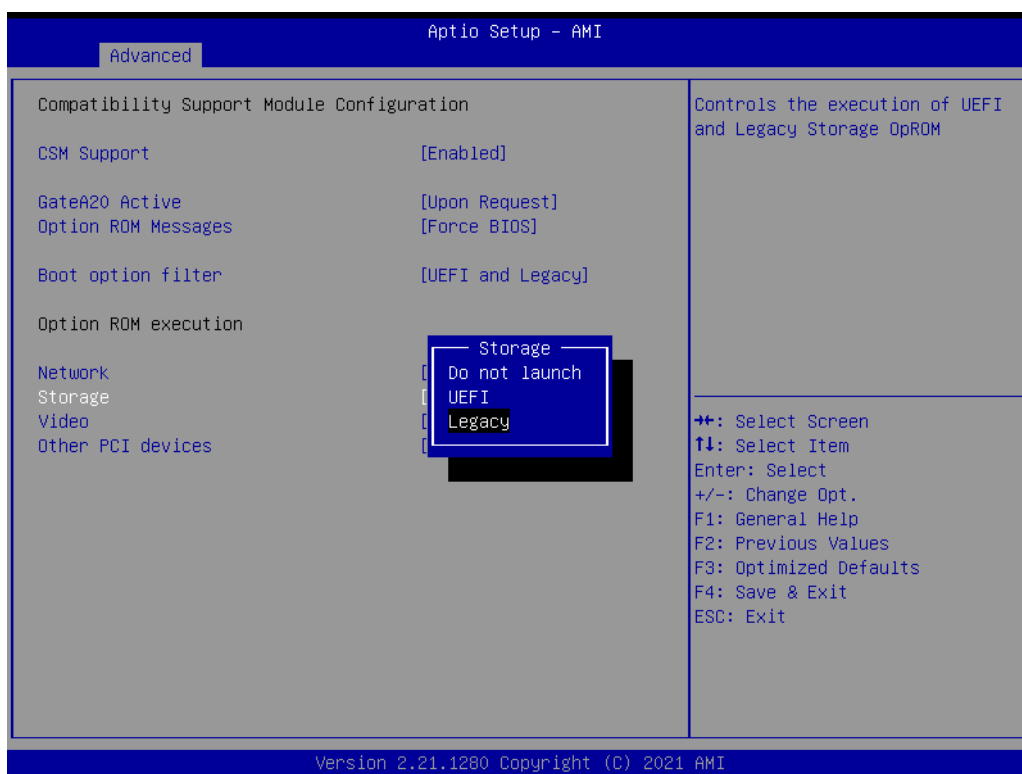

- **Video**
Control the execution of UEFI and Legacy Video OpROM.

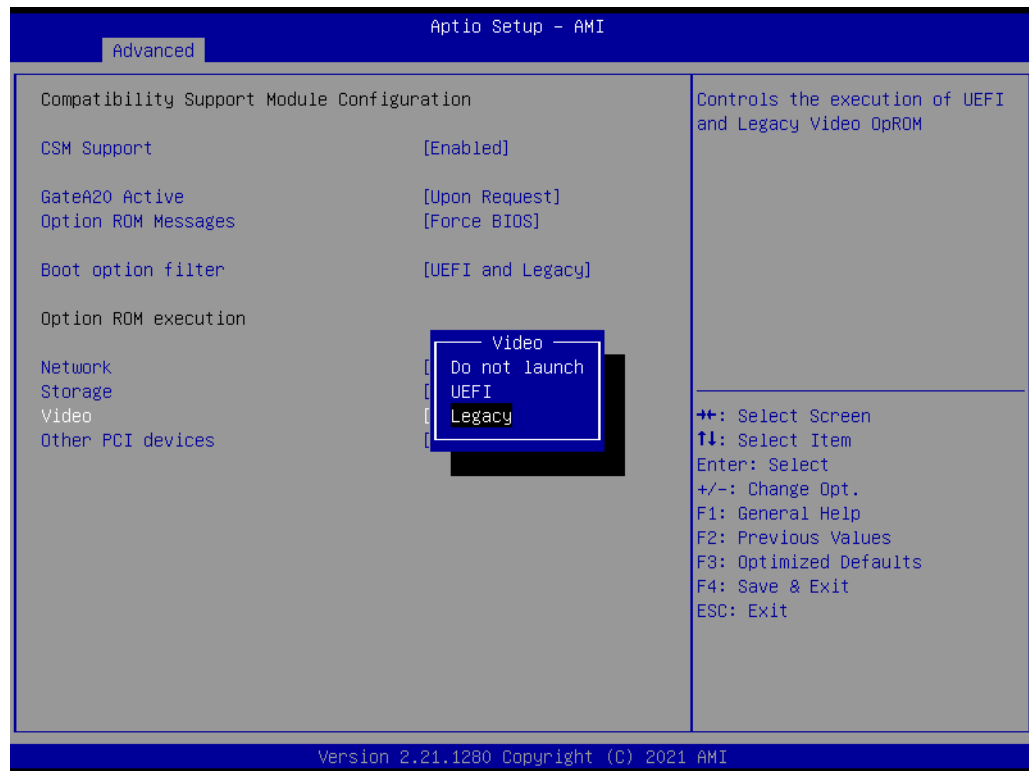

- **Other PCI Devices**
Determines OpROM execution policy for devices other than Network., Storage, or Video.

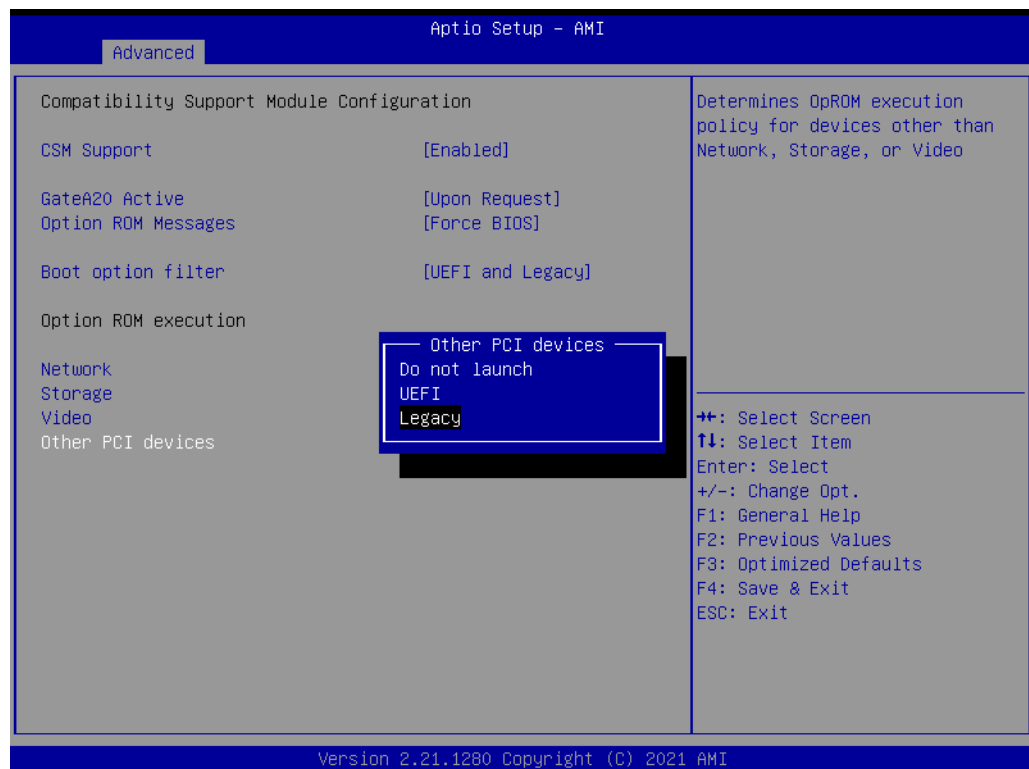

3.2.2.10 iSCSI Configuration

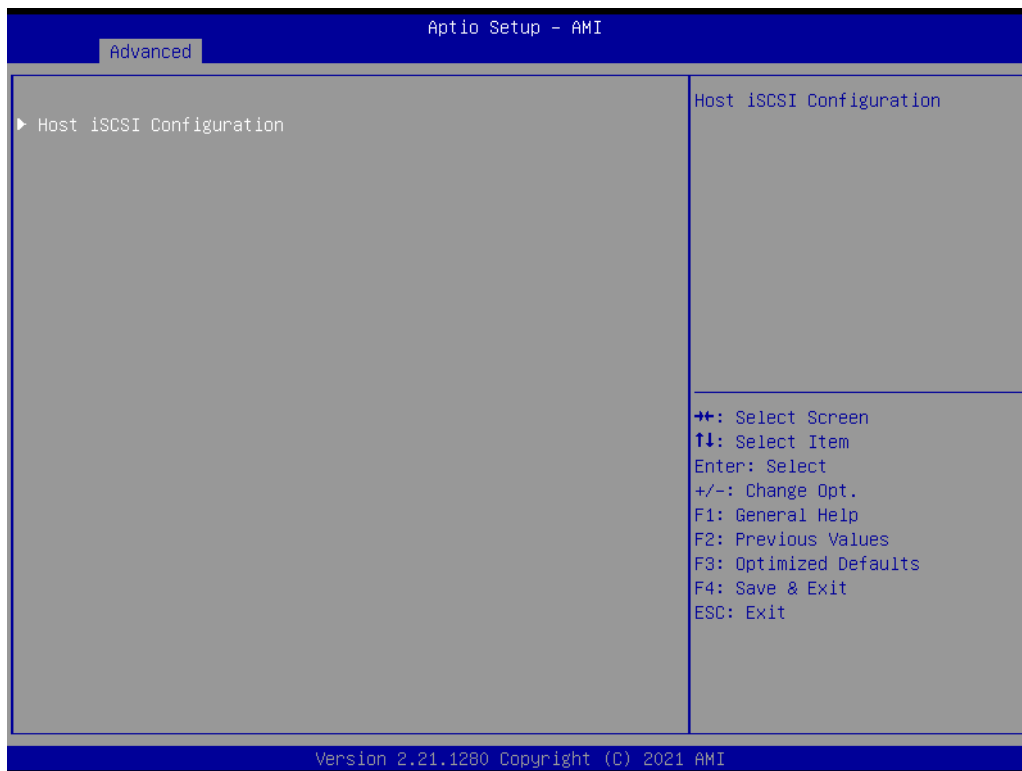

- Host iSCSI Configuration**
 The worldwide unique name of iSCSI Initiator. Only IQN format is accepted. Range is from 4 to 223.

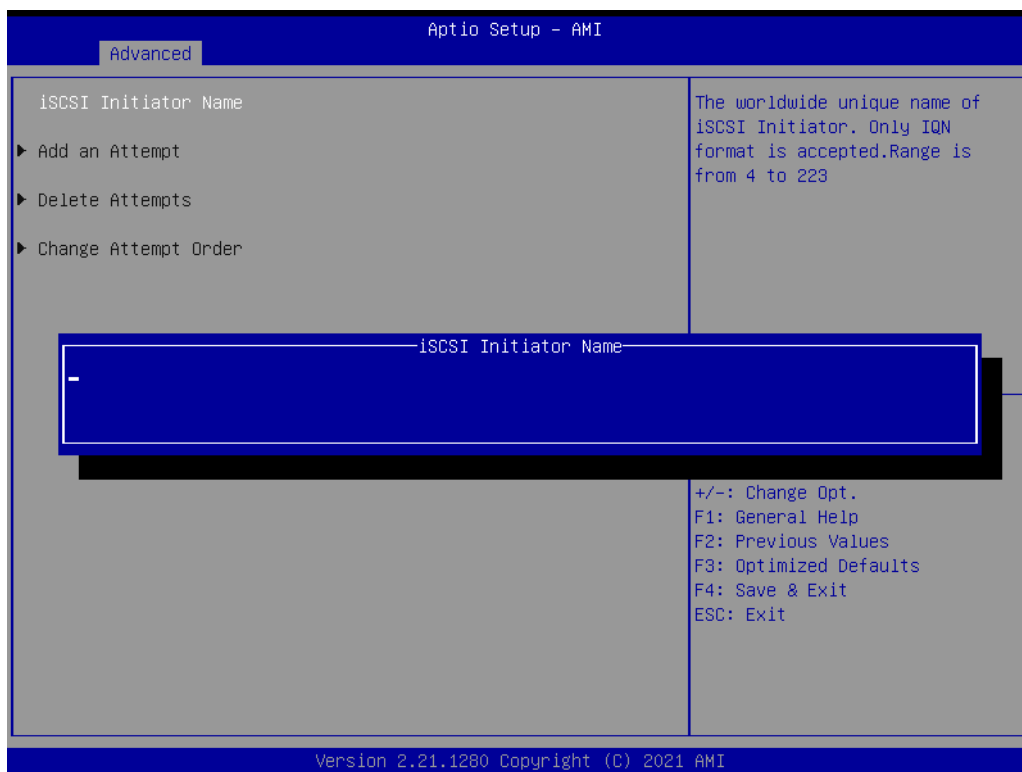

3.2.3 Platform Configuration

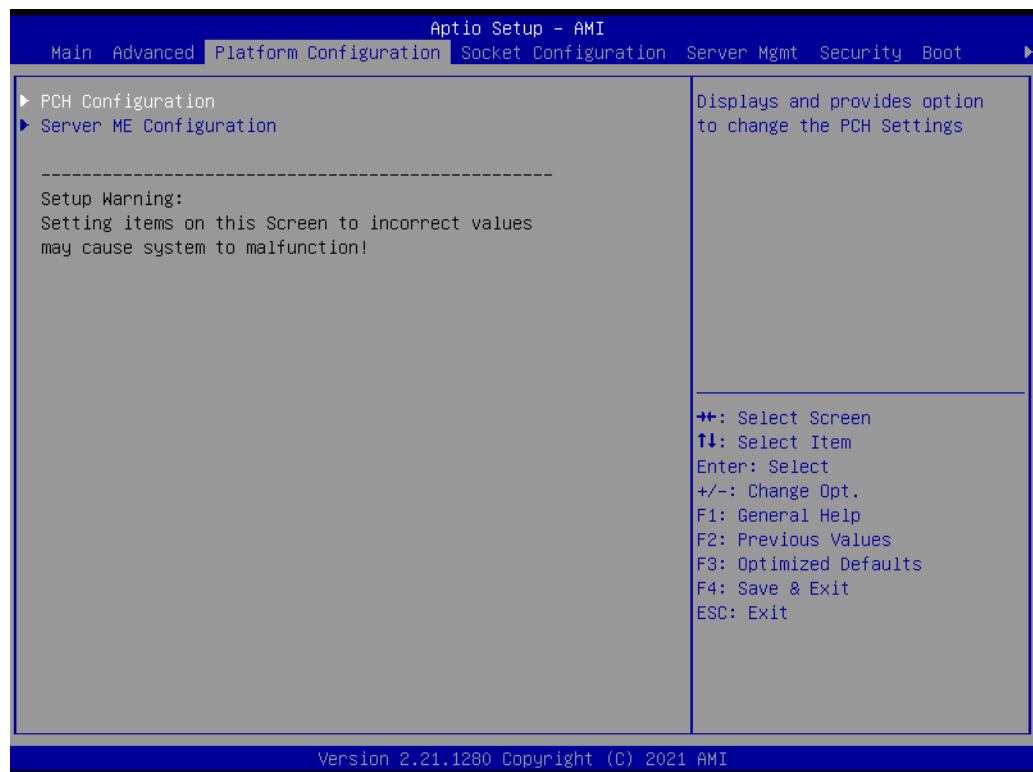

3.2.3.1 PCH Configuration

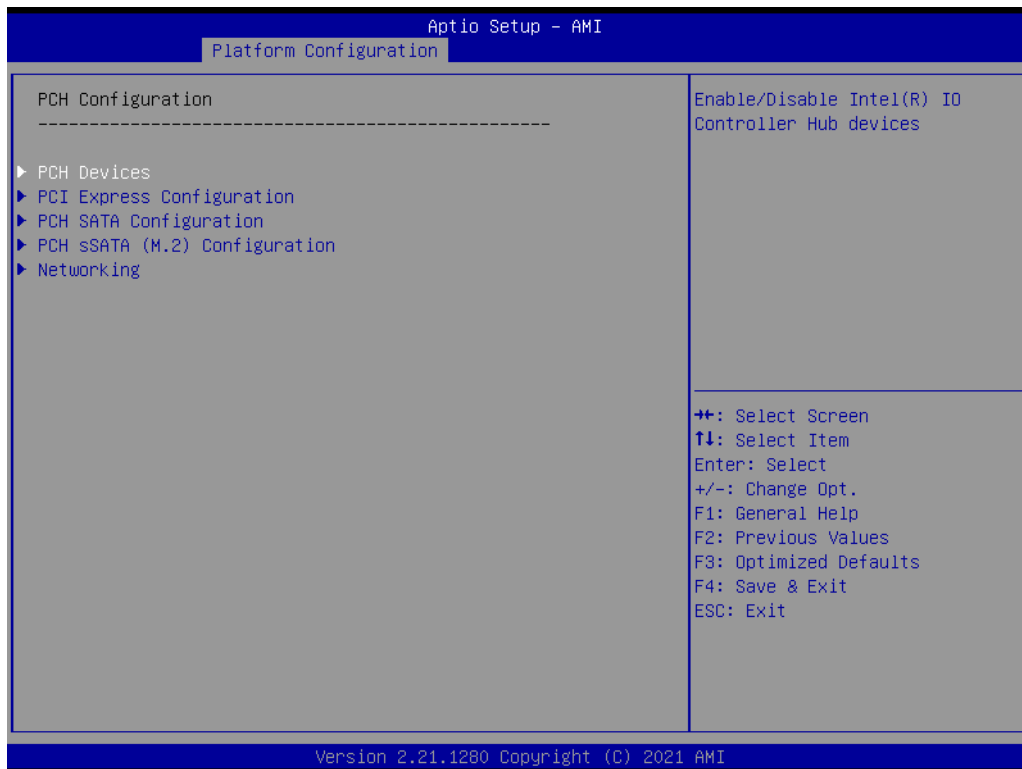

- **PCH Devices**
This item is to set up IO Controller Hub devices.
- **Restore AC Power Loss**
Specify what state to go to when power is re-applied after a power failure (G3 state).

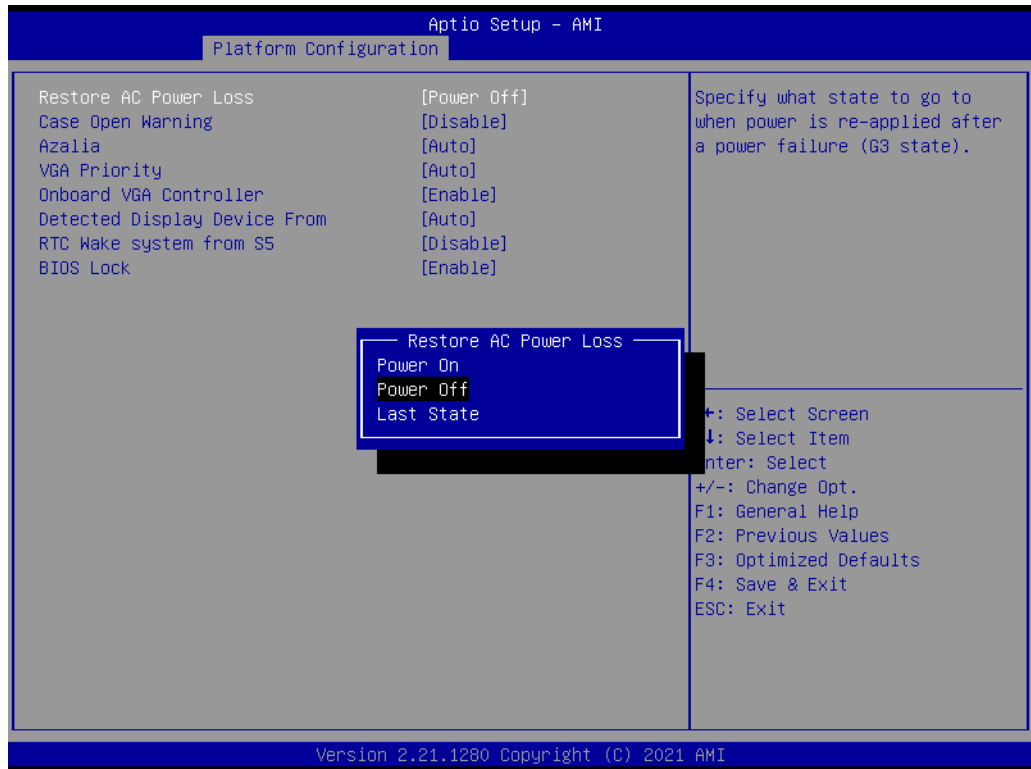

– **VGA Priority**

Determines priority between onboard and 1st off-board video device found.

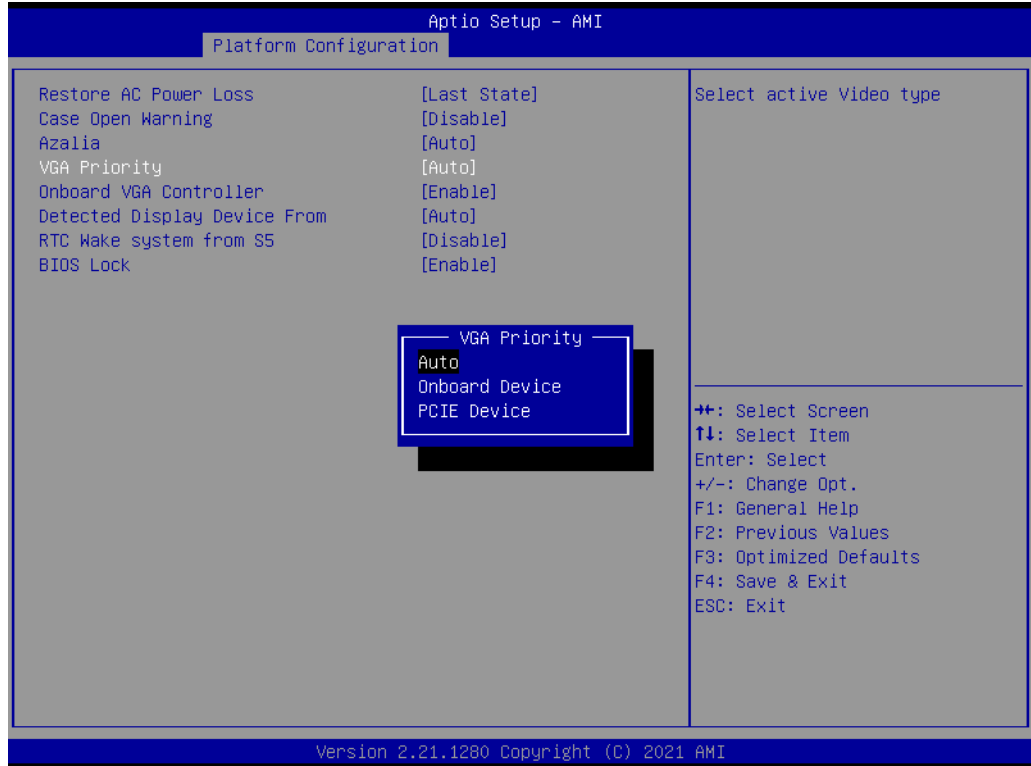

- **Onboard VGA Controller**
Enable/Disable Onboard VGA Controller (ASPEED AST2500).
- **Detected Display Device from**
Select to display from which PCIe Slot.

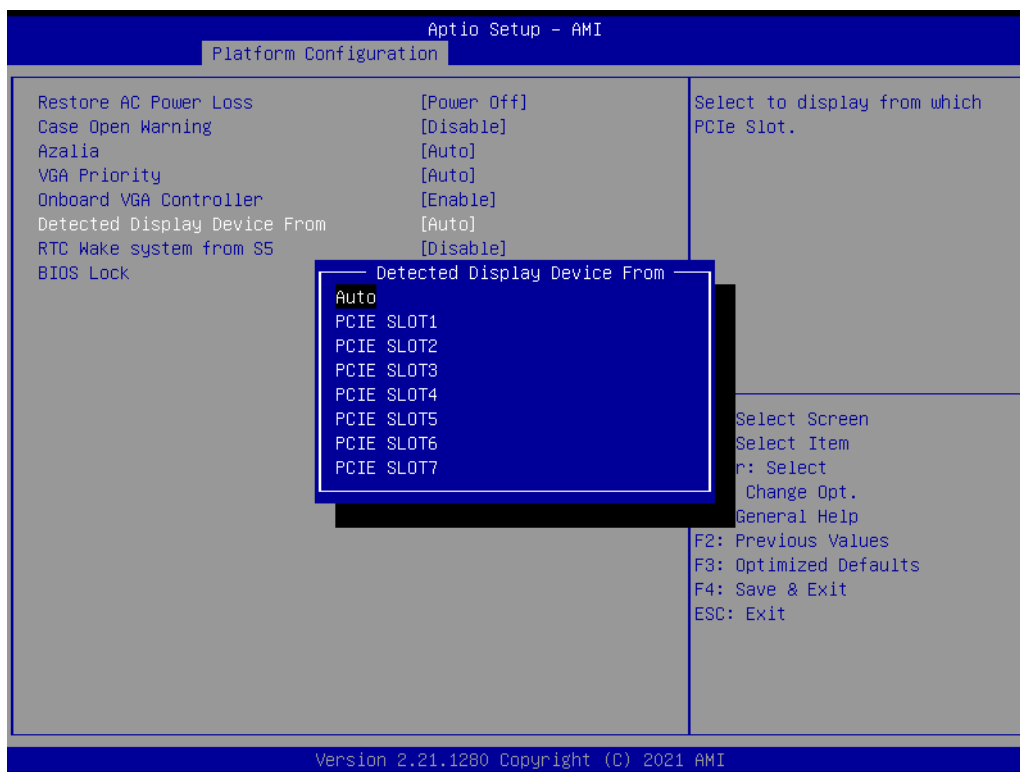

- **RTC Wake System from S5**
Enable or disable system wake on alarm event.
- **PCI Express Configuration**



- **PCIE SLOTS**
PCIE SLOTS Root Port Settings.

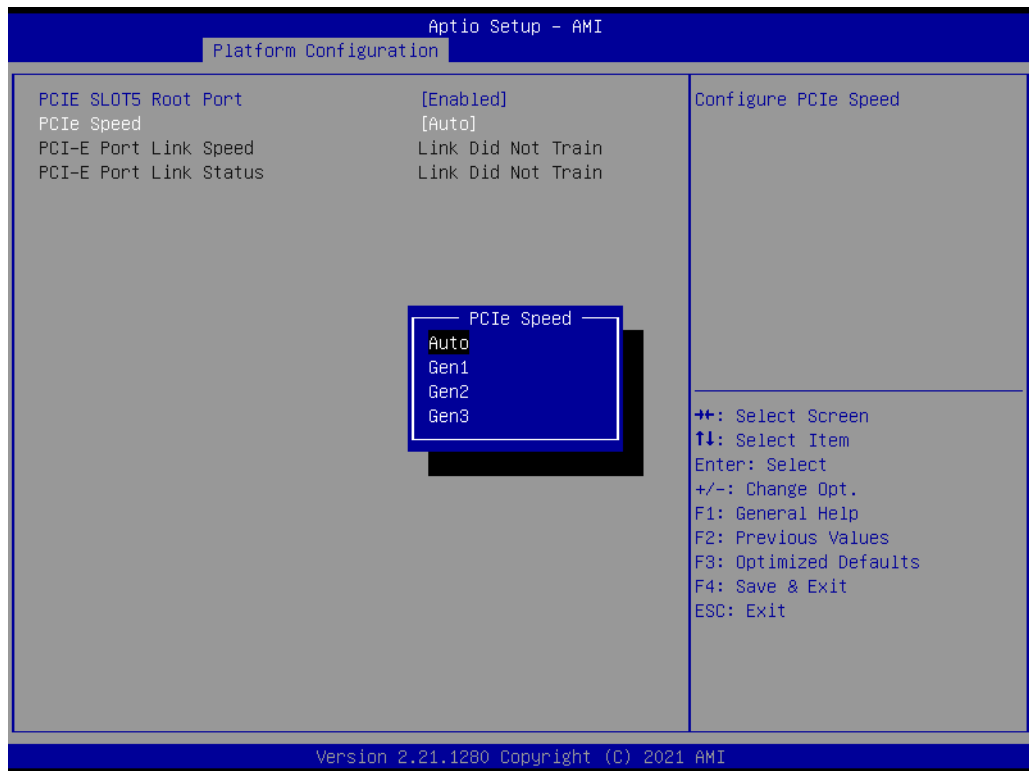

- **PCIe M.2 Slot**
M.2 PCIE SLOT Root Port Settings.

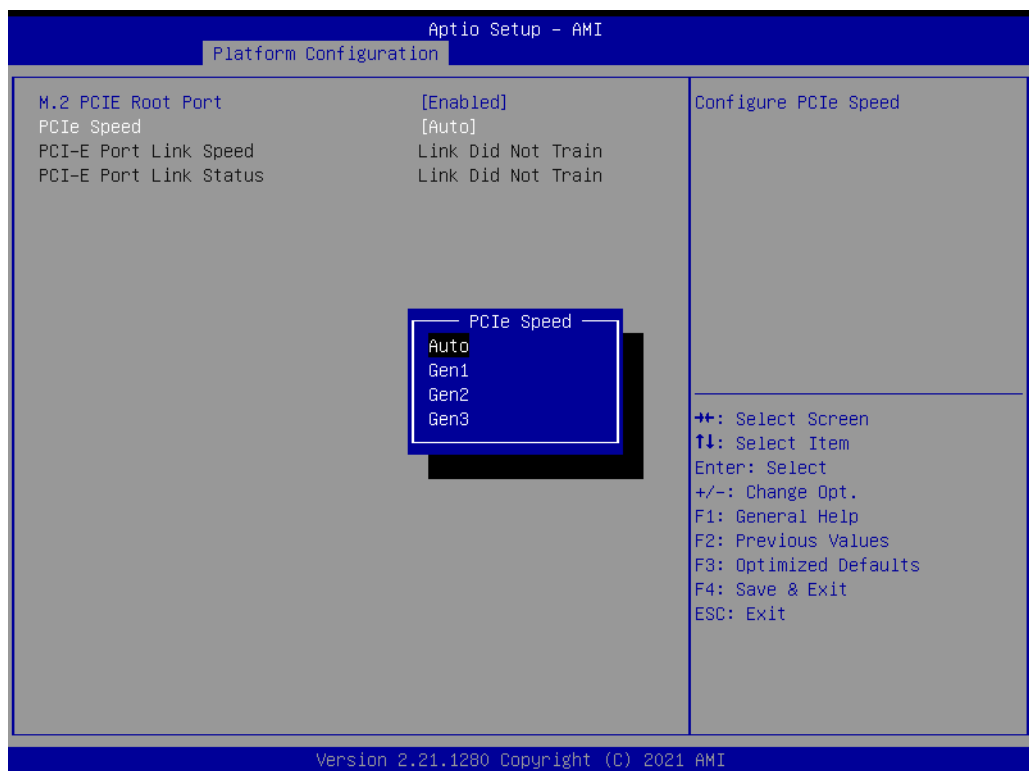

■ PCH SATA Configuration

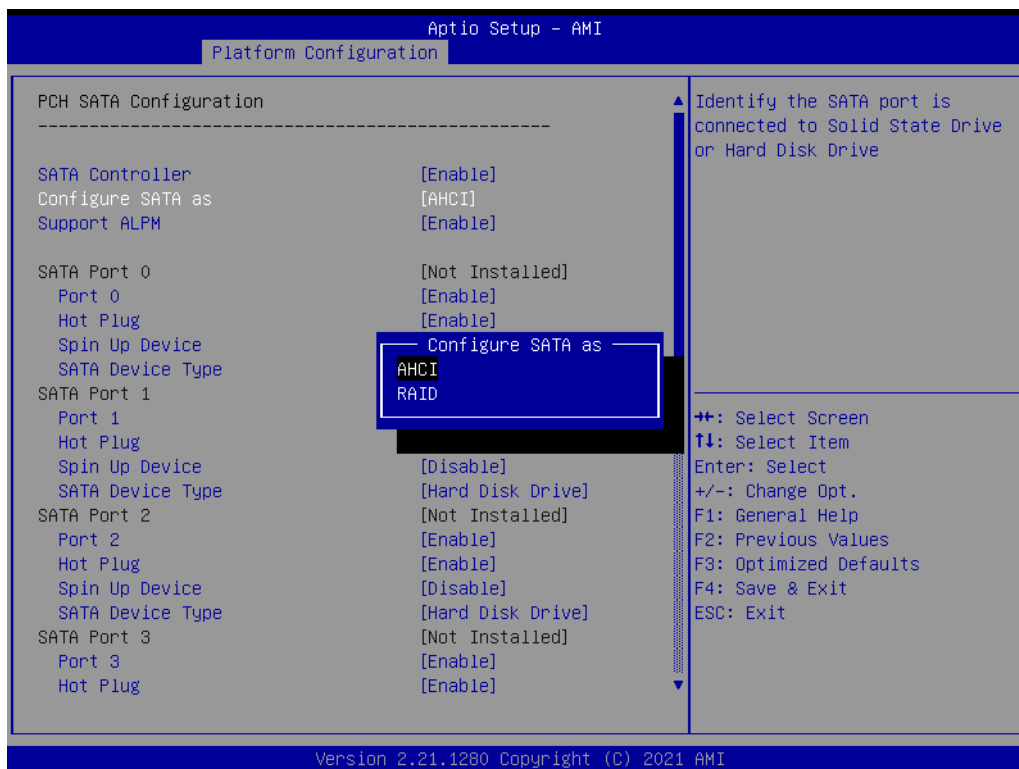
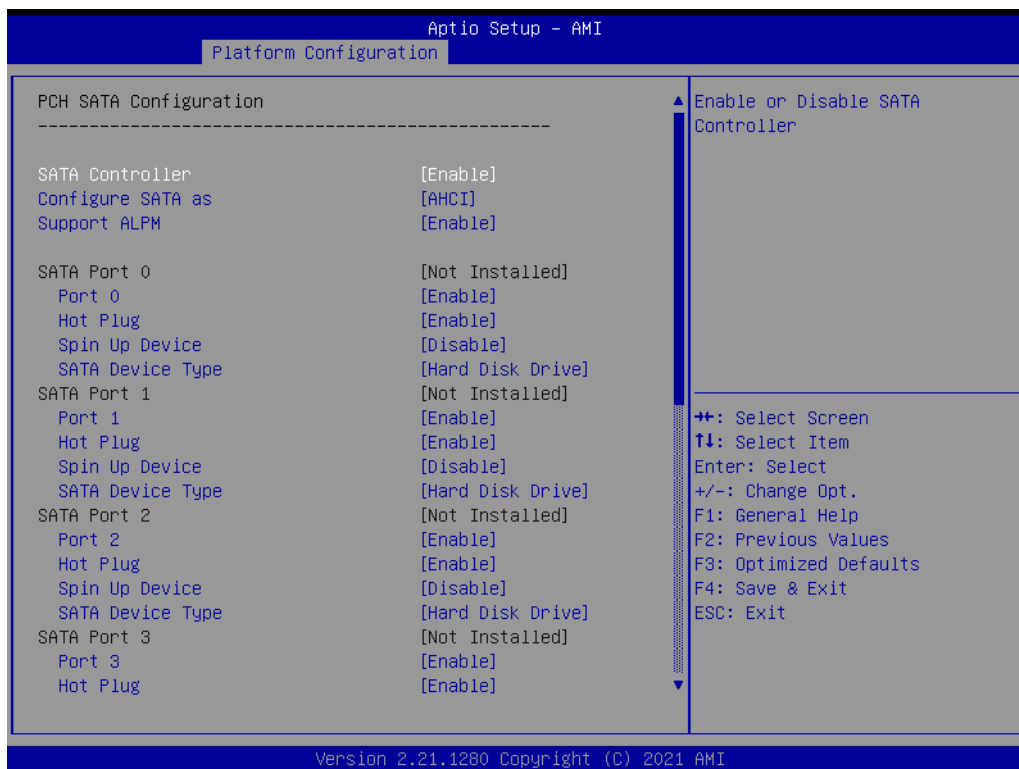

- **SATA Controller**
Enable or disable SATA devices.
- **Configure SATA as**
Set as AHCI or RAID when SATA controllers are enabled.
- **Support ALPM**

Enable or disable Aggressive Link Power Management (ALPM) protocol for Advanced Host Controller Interface-compliant (AHCI) Serial ATA (SATA) devices.

– **SATA Port 0~7**

Enable or disable SATA port 0~7.

– **Hot Plug Port 0~7**

Designates SATA port 0~7 as hot pluggable.

– **SATA Port 0~7 Spin Up Device**

On an edge detect from 0 to 1, the PCH starts a COMRESET initialization sequence to the device.

– **SATA Port 0~7 Device Type**

To identify the SATA is connected to Solid State Drive or Hard Disk Drive.

■ **PCH sSATA (M.2) Configuration**

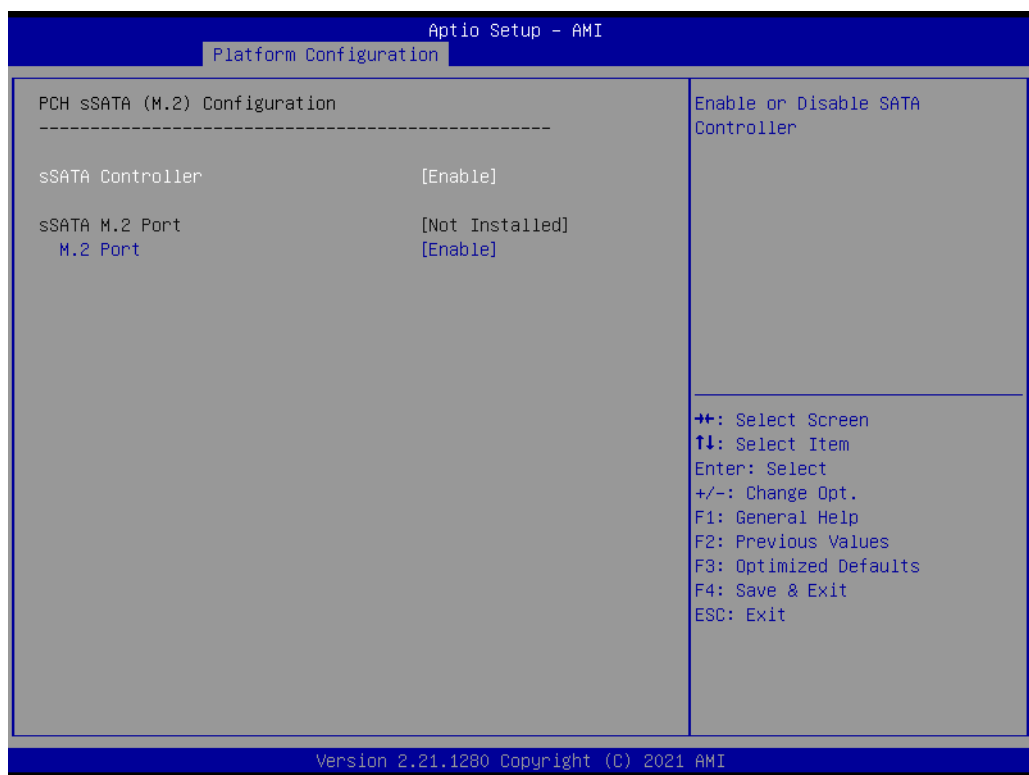

– **sSATA M.2 Controller**

Enable or disable SATA Controller.

– **sSATA M.2 Port**

Enable or disable SATA port.

■ Networking

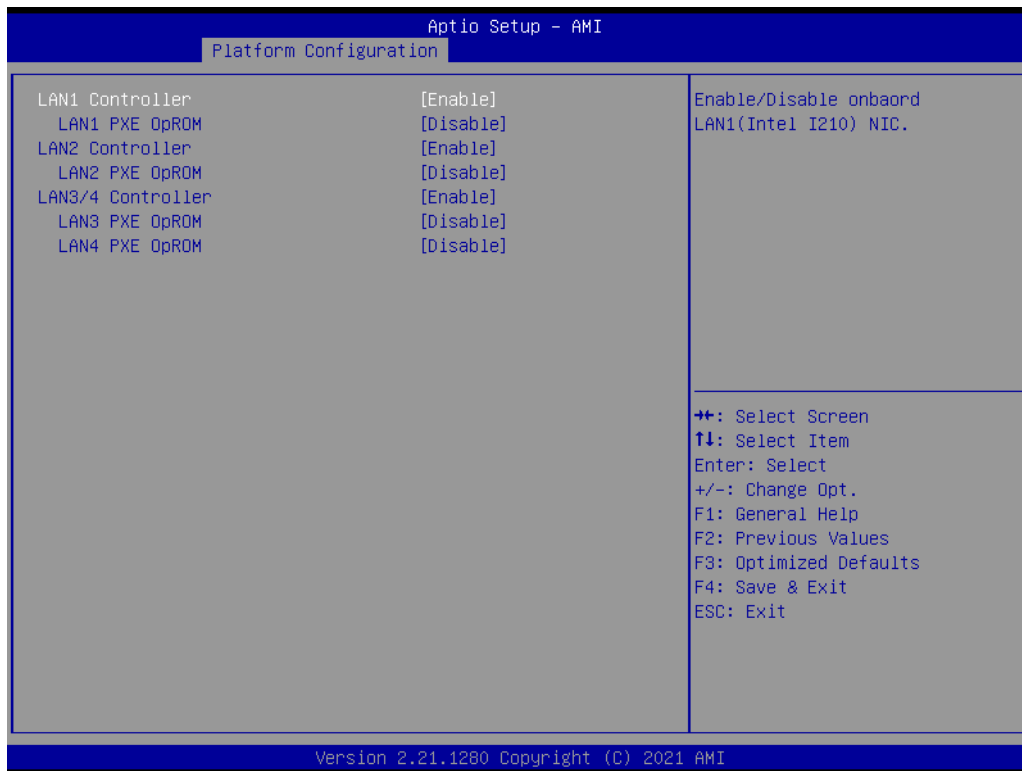

- **LAN1 Controller**
Enable or disable Intel I210 Controller support.
- **LAN1 PXE OpROM**
Enable or disable Boot option for Intel I210 controller.
- **LAN2 Controller**
Enable or disable Intel I210 Controller support.
- **LAN2 PXE OpROM**
Enable or disable Boot option for Intel I210 controller.
- **LAN3/LAN4 Controller**
Enable or disable Intel X550 controller support.
- **LAN3 PXE OpROM**
Enable or disable boot option for Intel X550 controller.
- **LAN4 PXE OpROM**
Enable or disable boot option for Intel X550 controller.

3.2.3.2 Server ME Configuration

This page shows the Server ME configuration information.

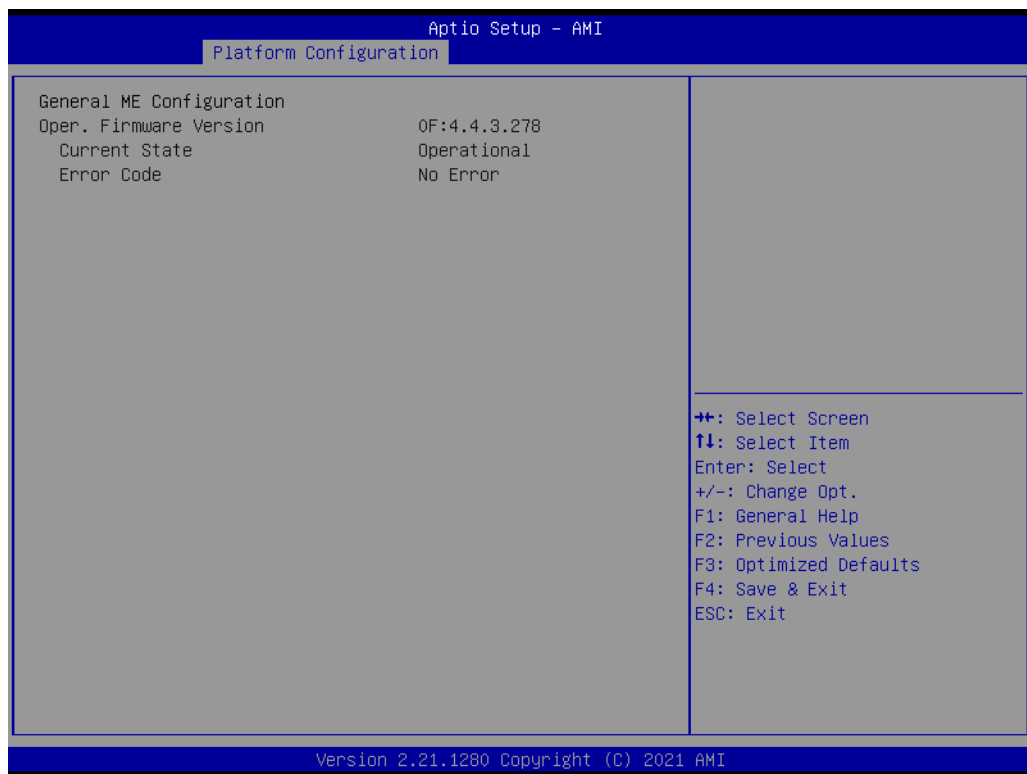

3.2.4 Socket Configuration

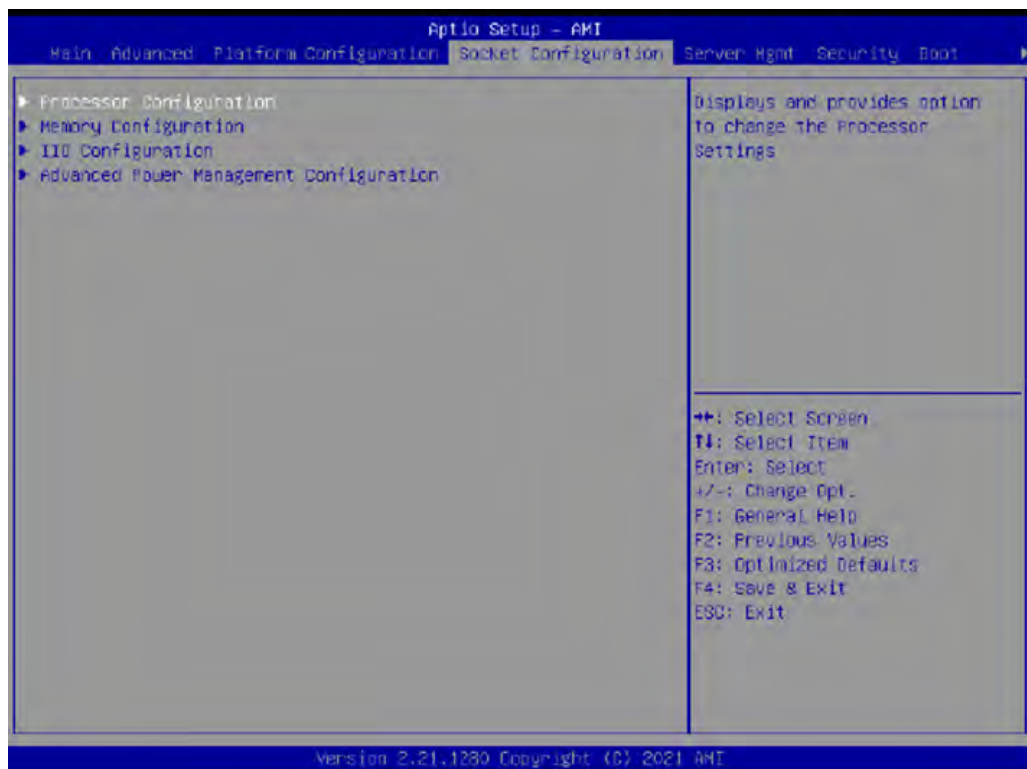

3.2.4.1 Processor Configuration

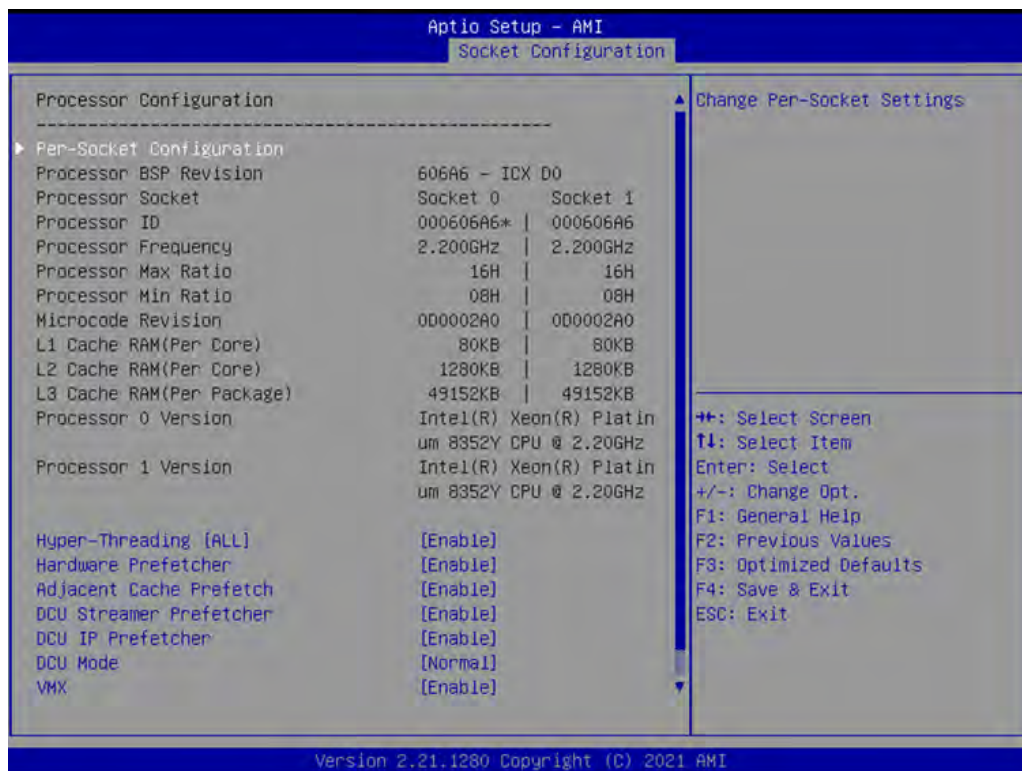

- **Per-Socket Configuration**
Use this to select how many processor cores you want to activate when you are using a dual or quad core processor.
- **Hyper-threading [All]**
Enable or disable Intel Hyper Threading technology.
- **Execute Disable Bit**
Enable or disable the Execute disable Bit feature. The Optimal and Fail-Safe default setting is enabled. If disable is selected, the BIOS forces the XD feature flag to always return to 0.
- **VMX**
Enable or disable Intel Virtual Machine Extensions (VMX) for IA-32 processors that support Intel® Vanderpool Technology.
- **Enable SMX**
Enable or disable Safer Mode Extensions. Safer Mode Extensions (SMX) provide a means for system software to launch an MLE and establish a measured environment within the platform to support trust decisions by end users.
- **Hardware Prefetcher**
Hardware Prefetcher is a technique that fetches instructions and/or data from memory into the CPU cache memory well before the CPU needs it, so that it can improve the load-to-use latency.
- **Adjacent Cache Prefetch**
The Adjacent Cache-Line Prefetch mechanism, like automatic hardware prefetch, operates without programmer intervention. When enabled through the BIOS, two 64-byte cache lines are fetched into a 128-byte sector, regardless of whether the additional cache line has been requested or not.

- **DCU Streamer Prefetcher**
Enable prefetch of next L1 data line based upon multiple loads in same cache line.
- **DCU IP Prefetcher**
Enable prefetch of next L1 line based upon sequential load history.
- **DCU Mode**
Change the data cache unit mode.
- **AES-NI**
This item is to Enable or disable CPU advanced encryption standard instructions.

3.2.4.2 UPI Configuration



- **UPI Status**
Display information of Intel UltraPath Interconnect (UPI).

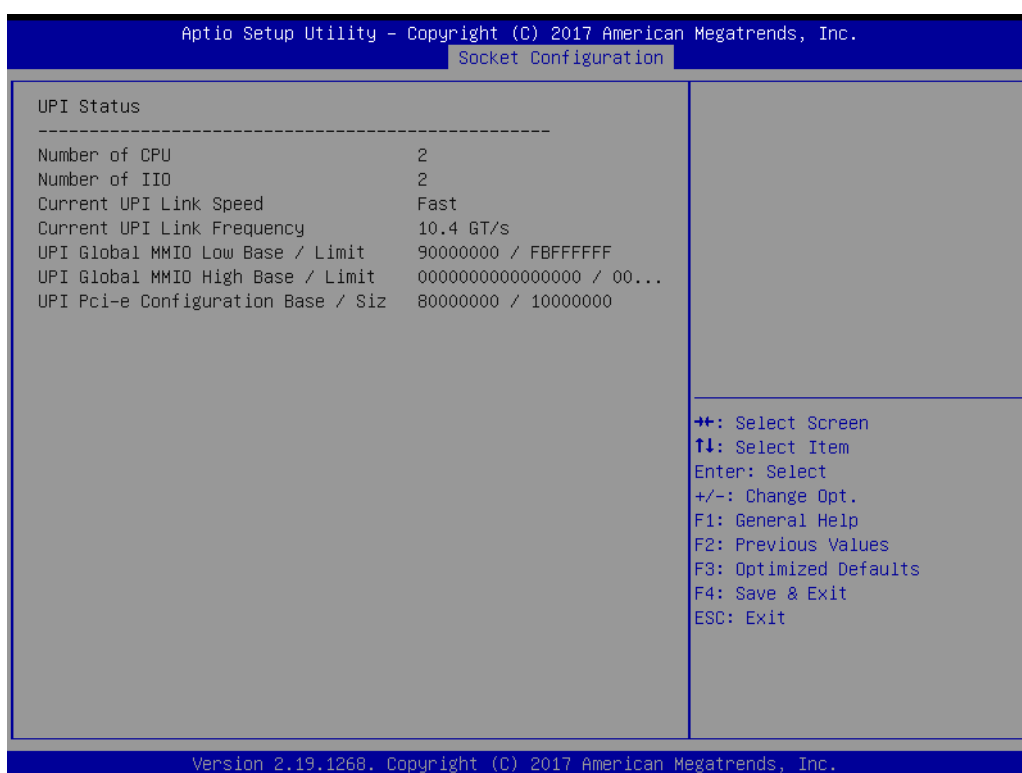
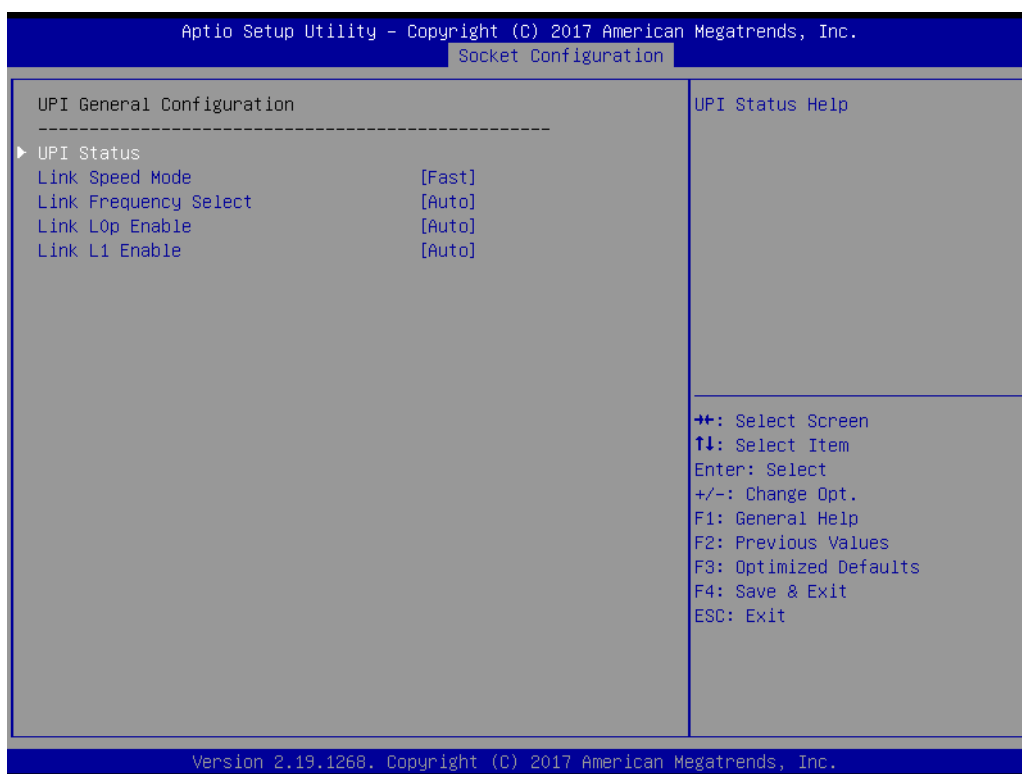

- **Link Speed Mode**
Select the QPI link speed as either the Fast mode or Slow mode.

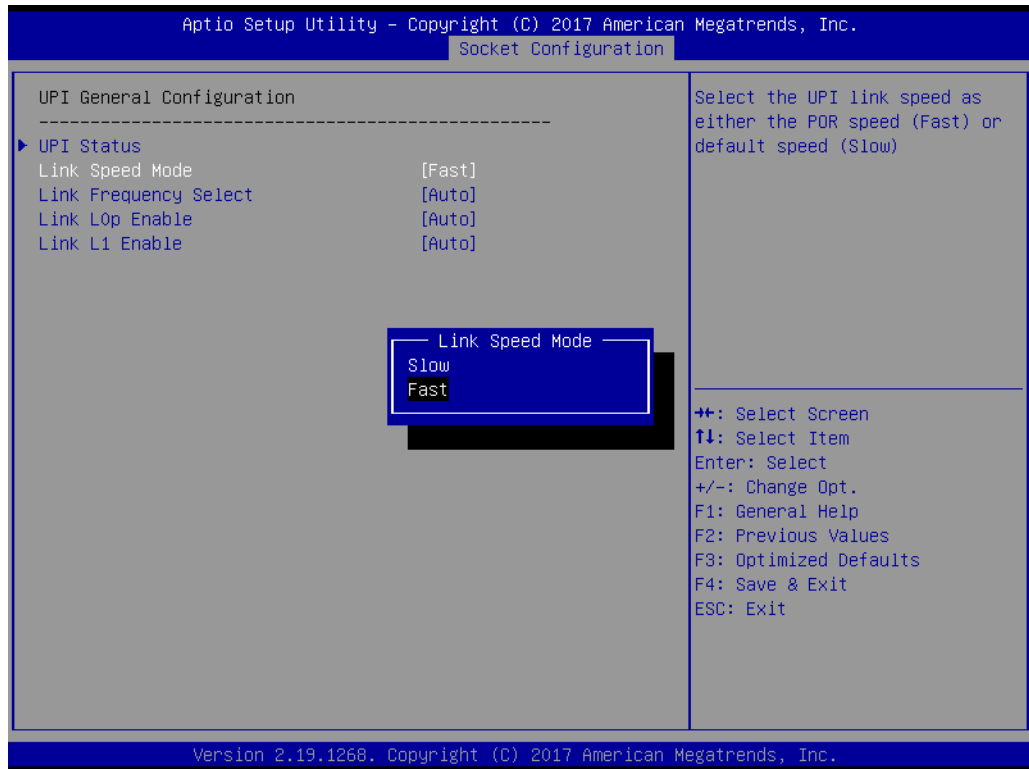

- **Link Frequency Select**
Allows for selecting the QPI Link frequency.

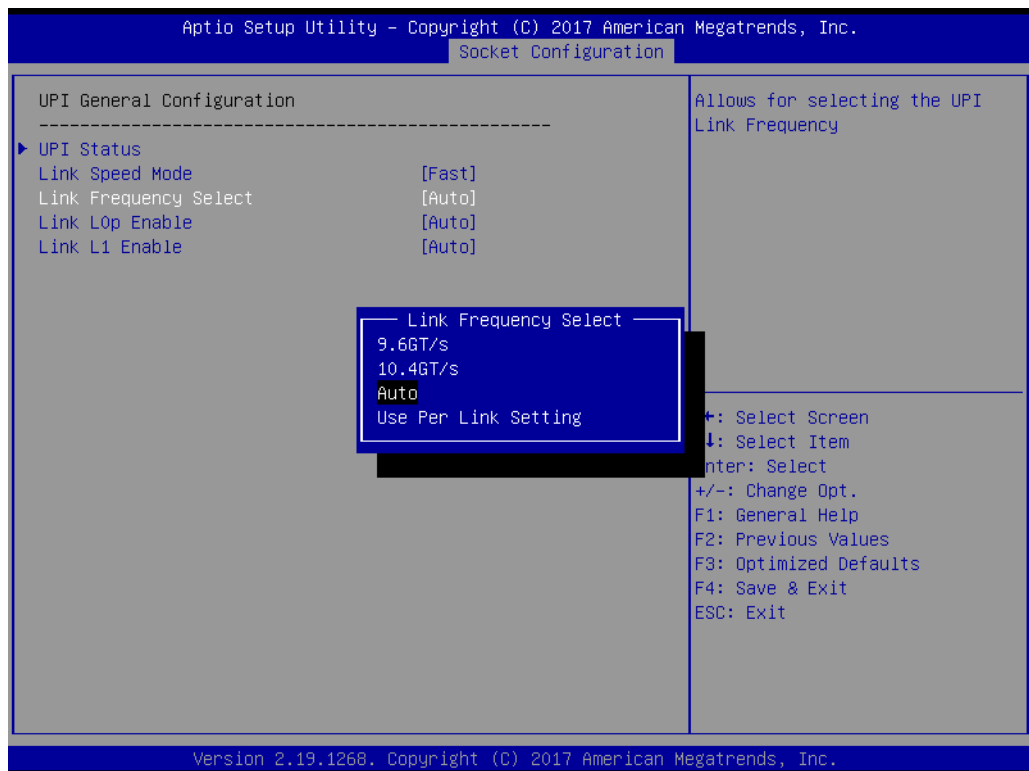

- **Link L0p Enable**
Enable or disable QPI Link0p.

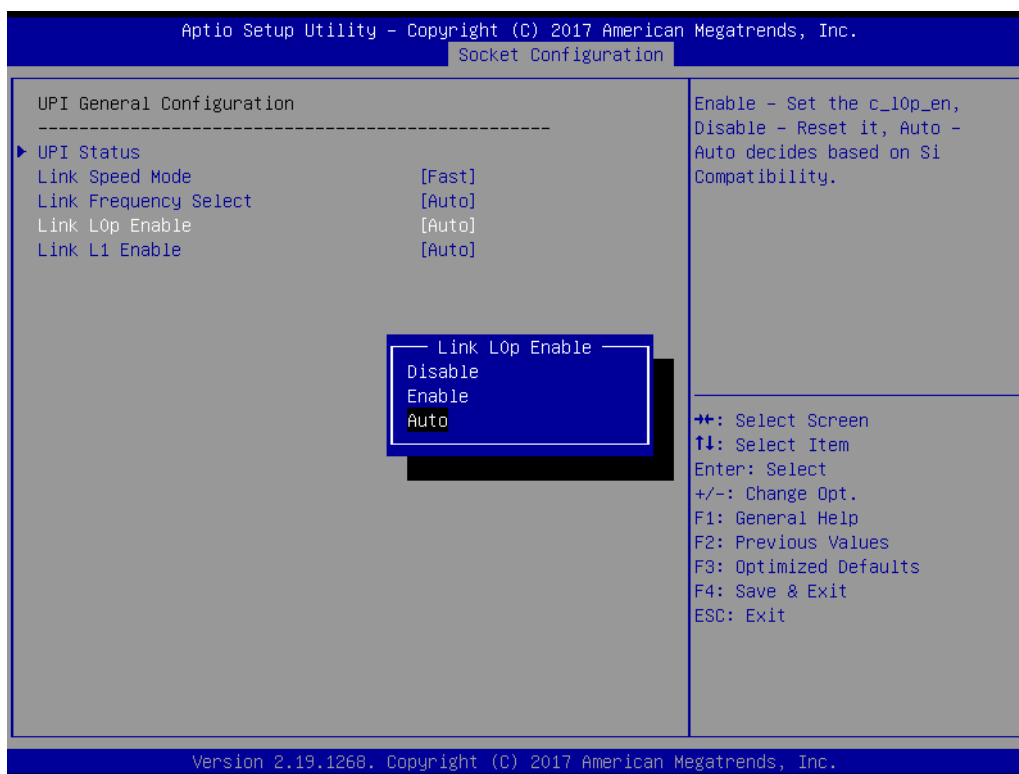

- **Link L1 Enable**
Enable or disable QPI Link1.

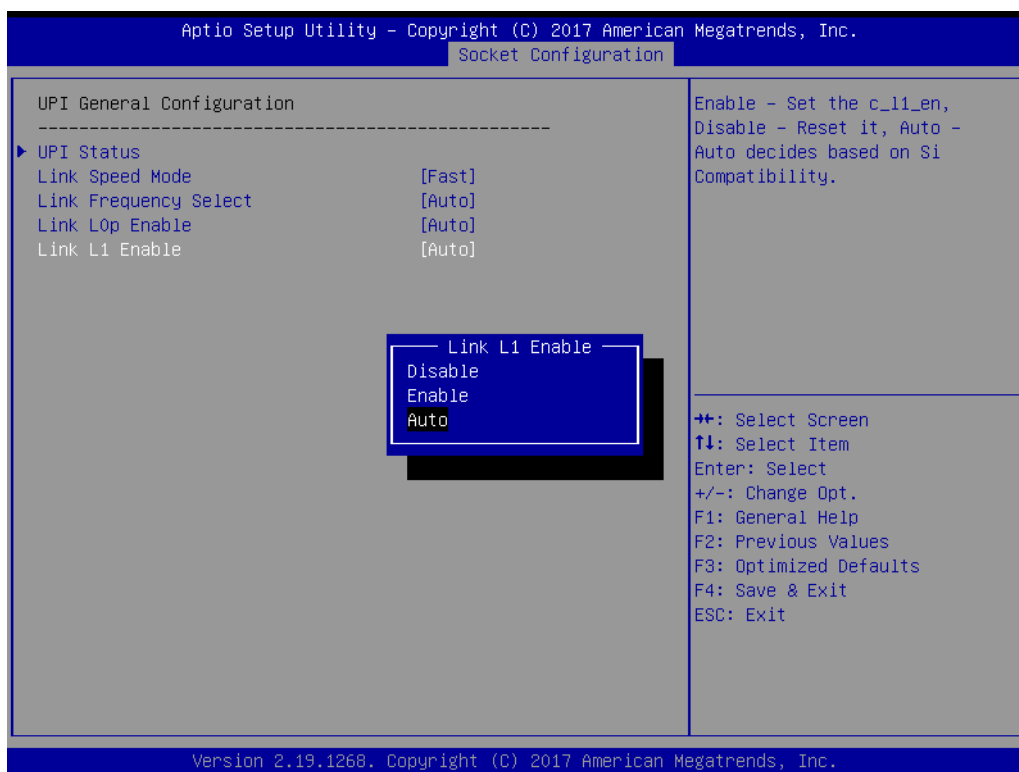

3.2.4.3 Memory Configuration

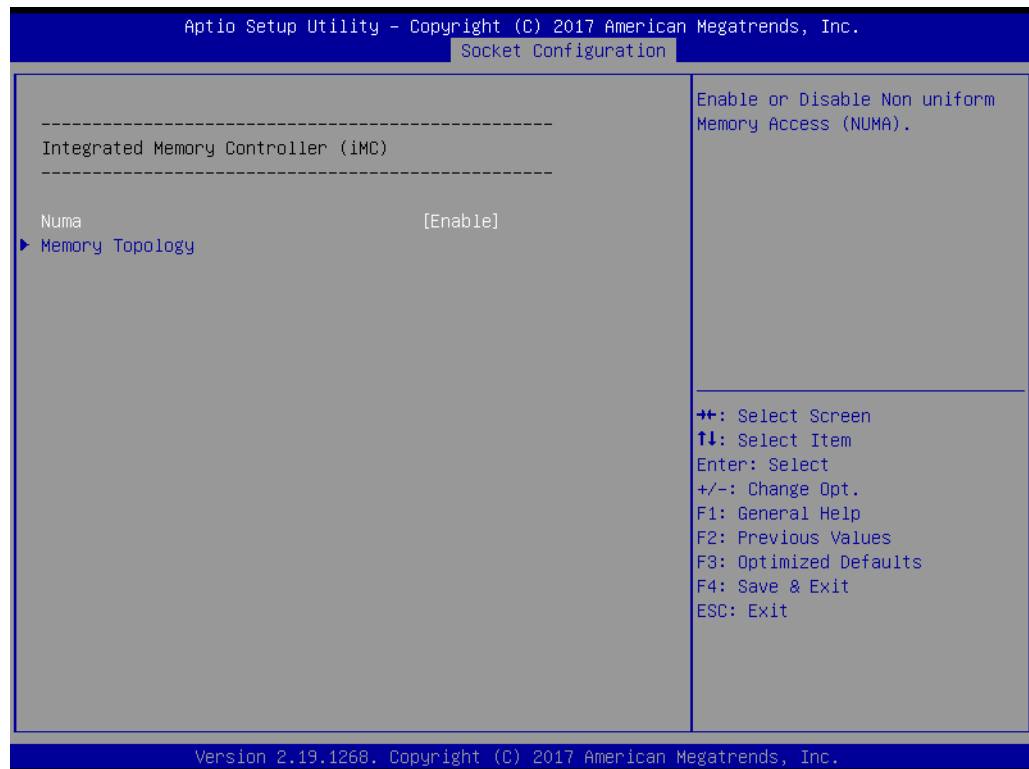

- **NUMA**
Enable or disable non uniform memory access (NUMA).
- **Memory Technology**
Display memory topology with DIMM population information.

3.2.4.4 IIO Configuration

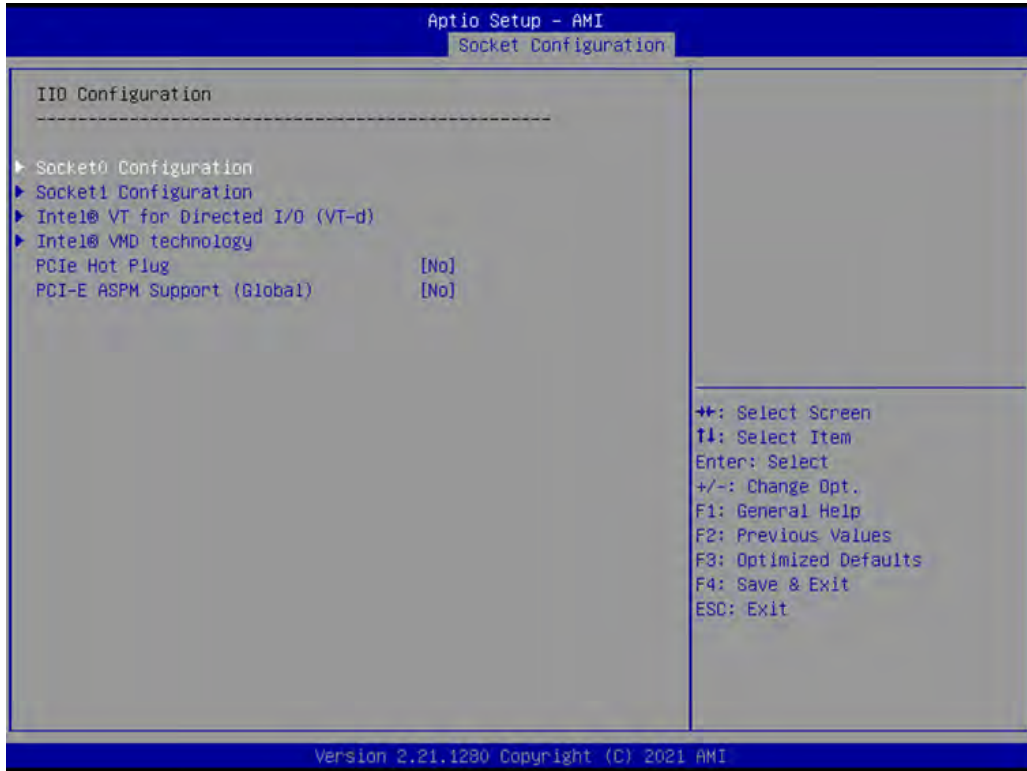

- **Socket0 PCIe Configuration**

PCIe port bifurcation control and select target link speed as Gen1, Gen2, Gen3, Gen4.

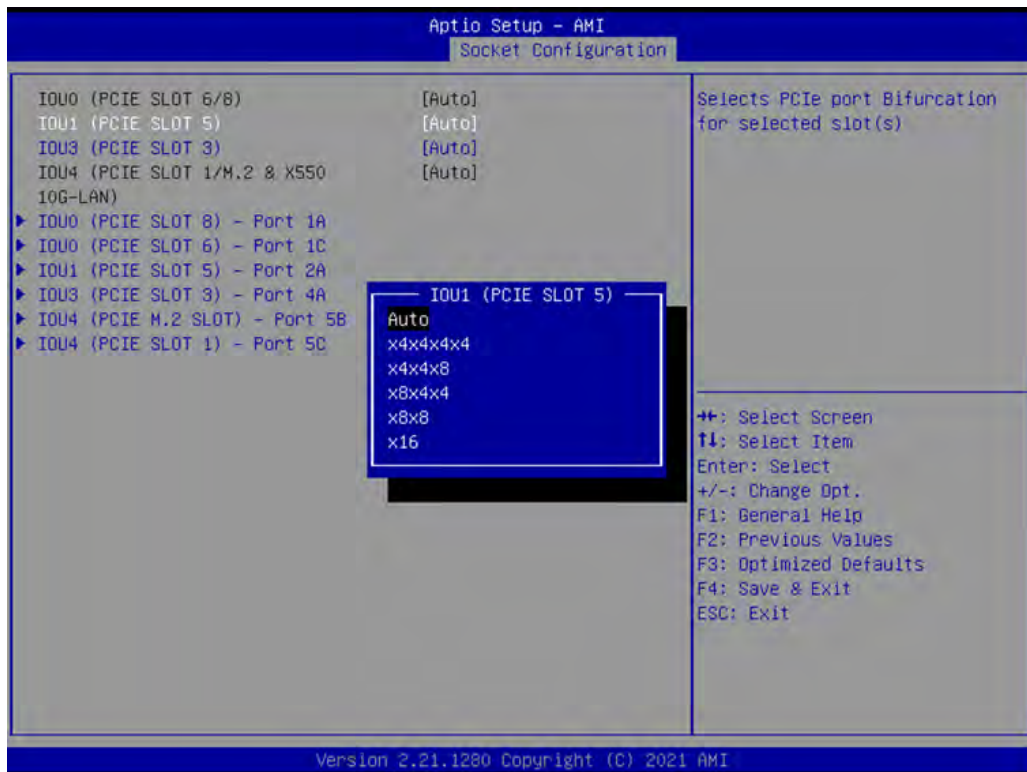

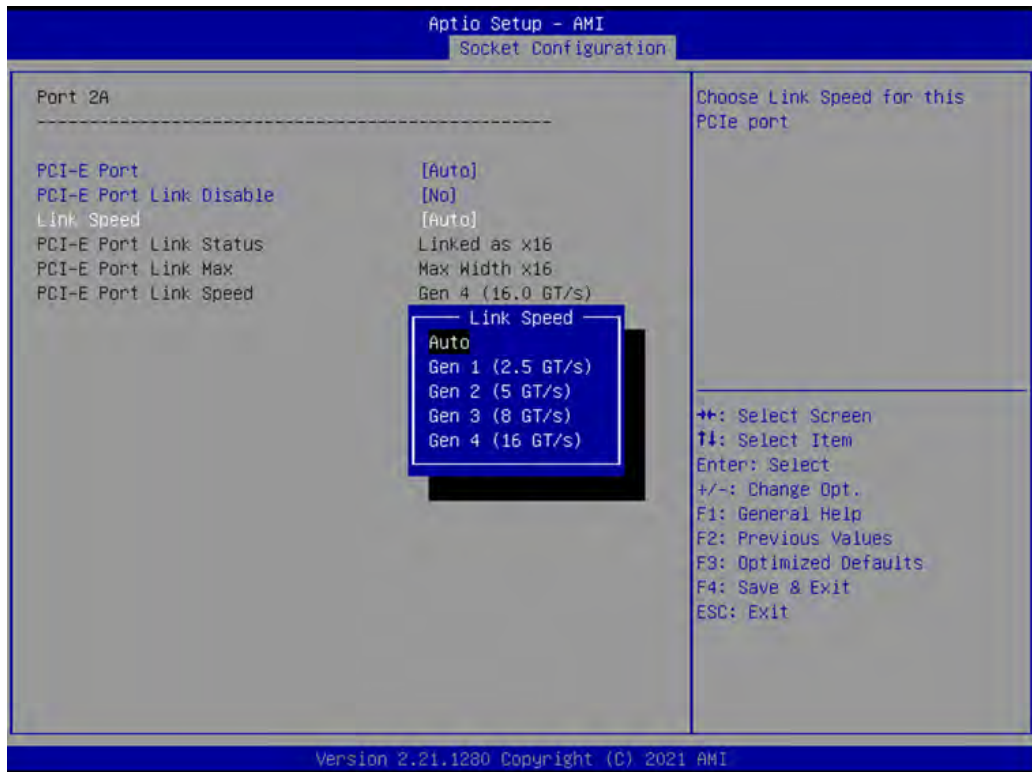

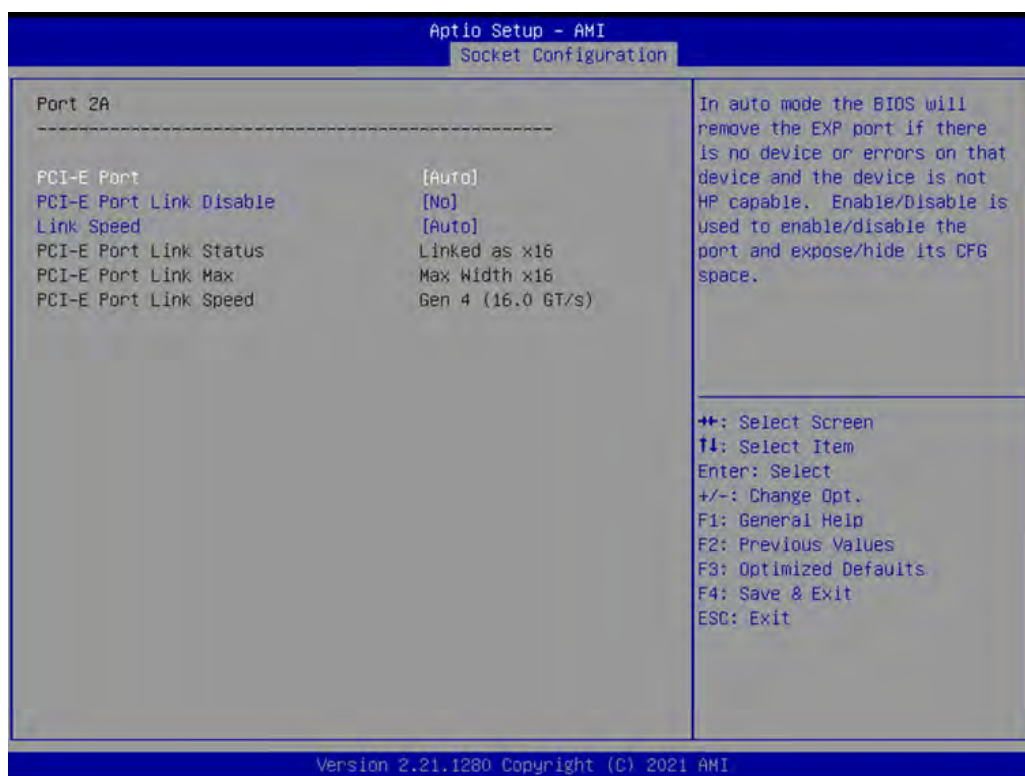
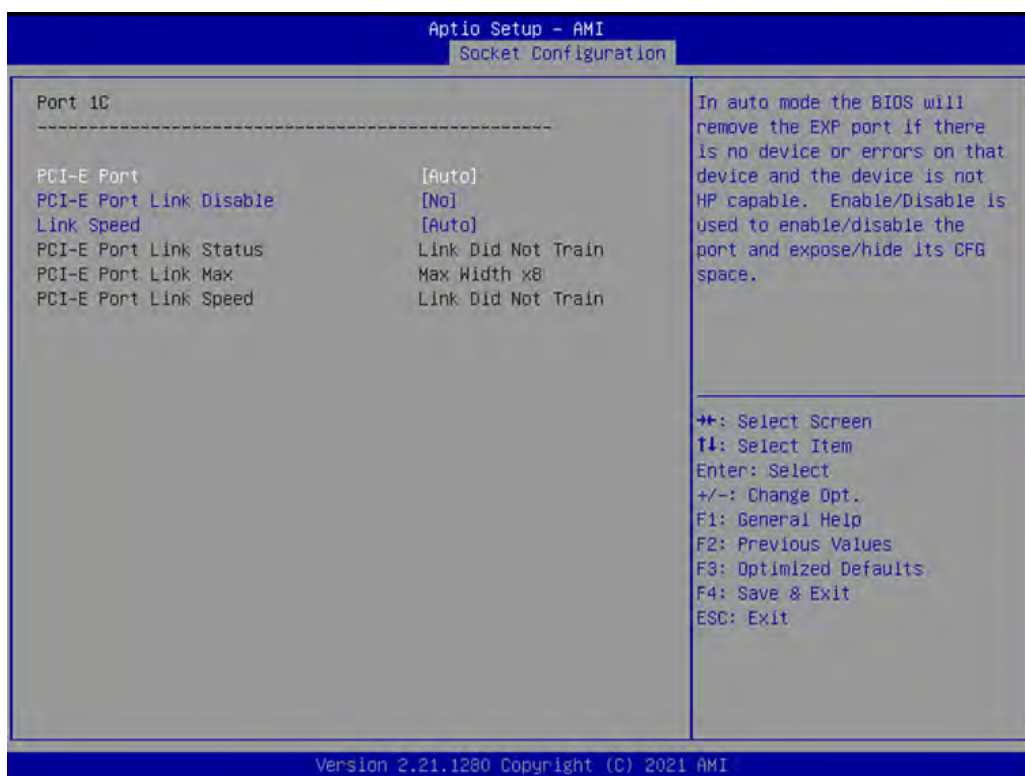

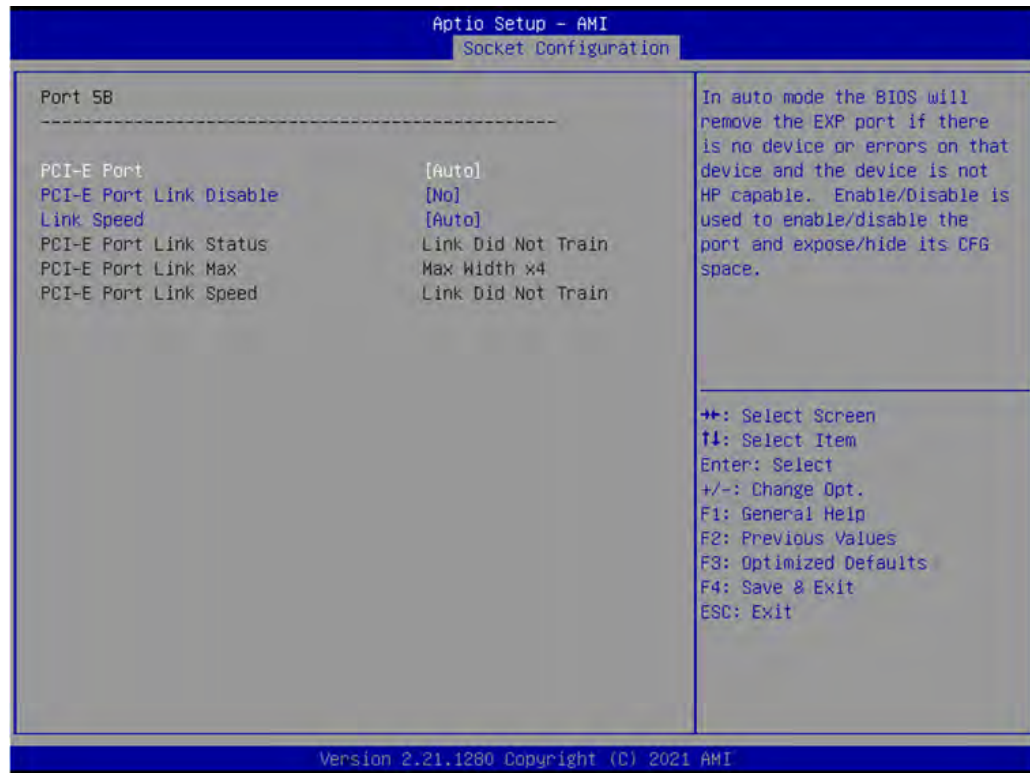
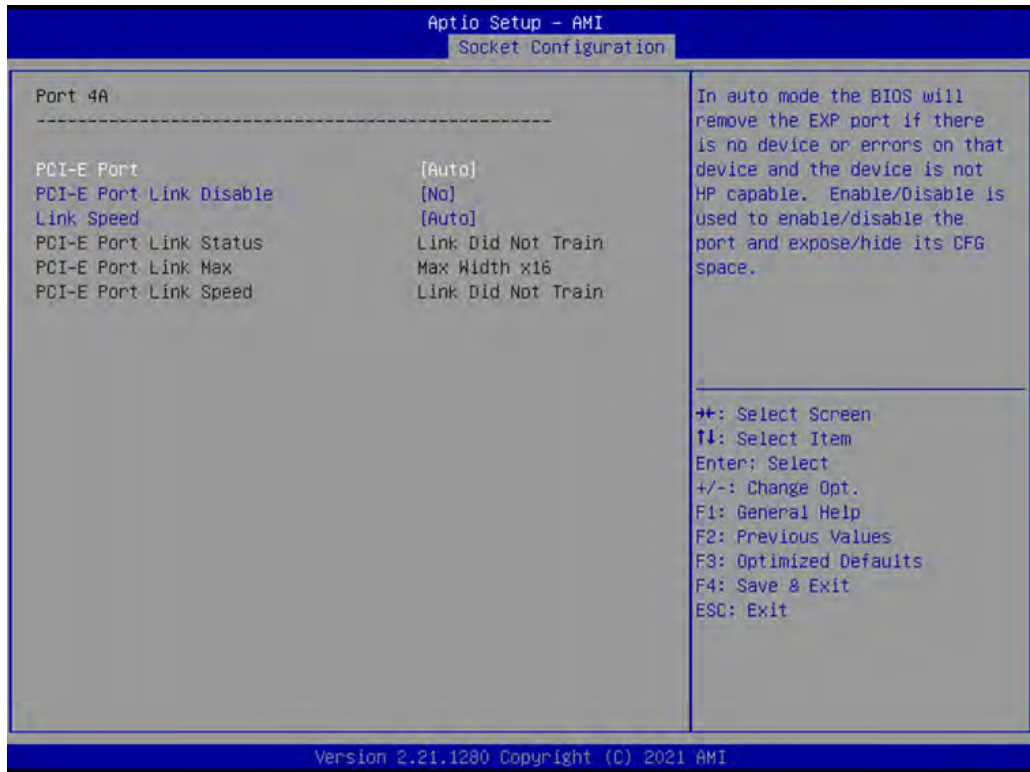

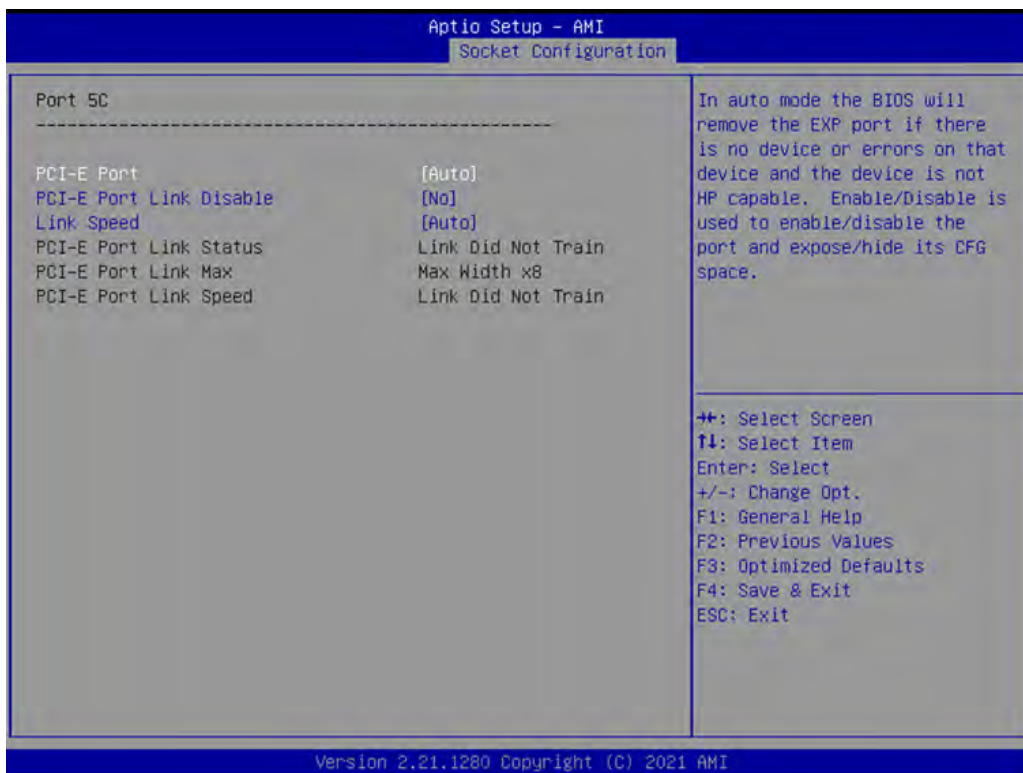

■ Socket1 PCIe Configuration

PCIe port bifurcation control and select target link speed as Gen1, Gen2, Gen3, Gen4.

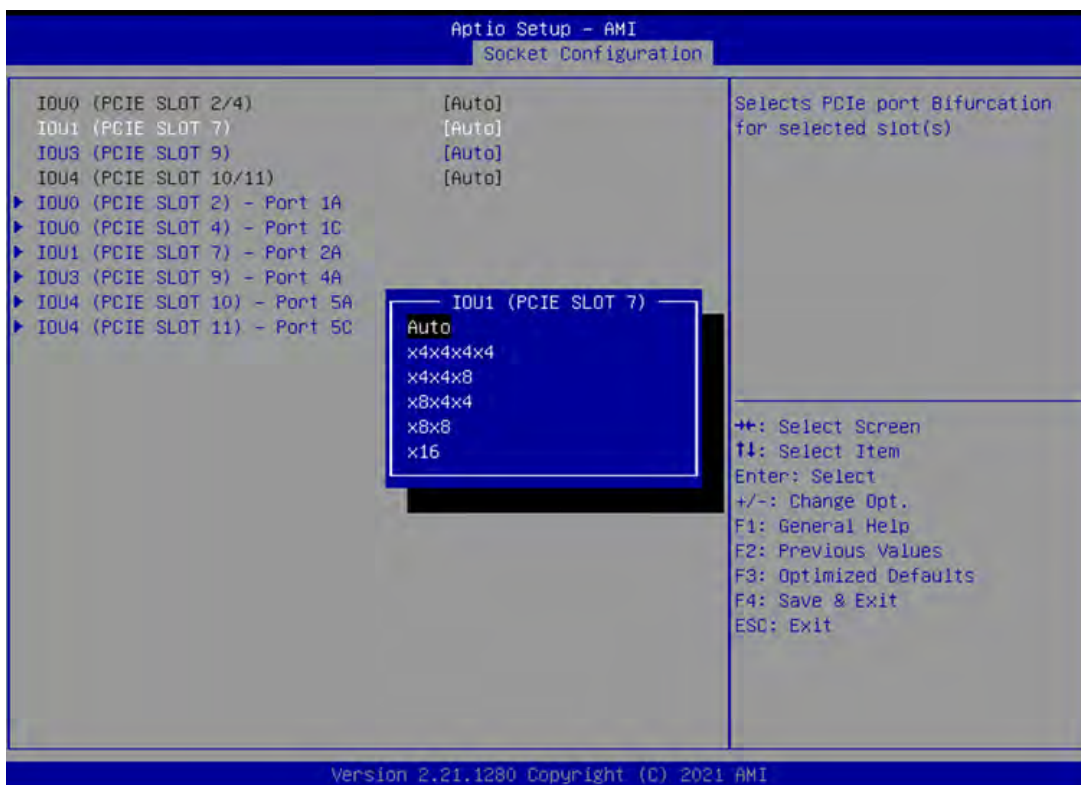

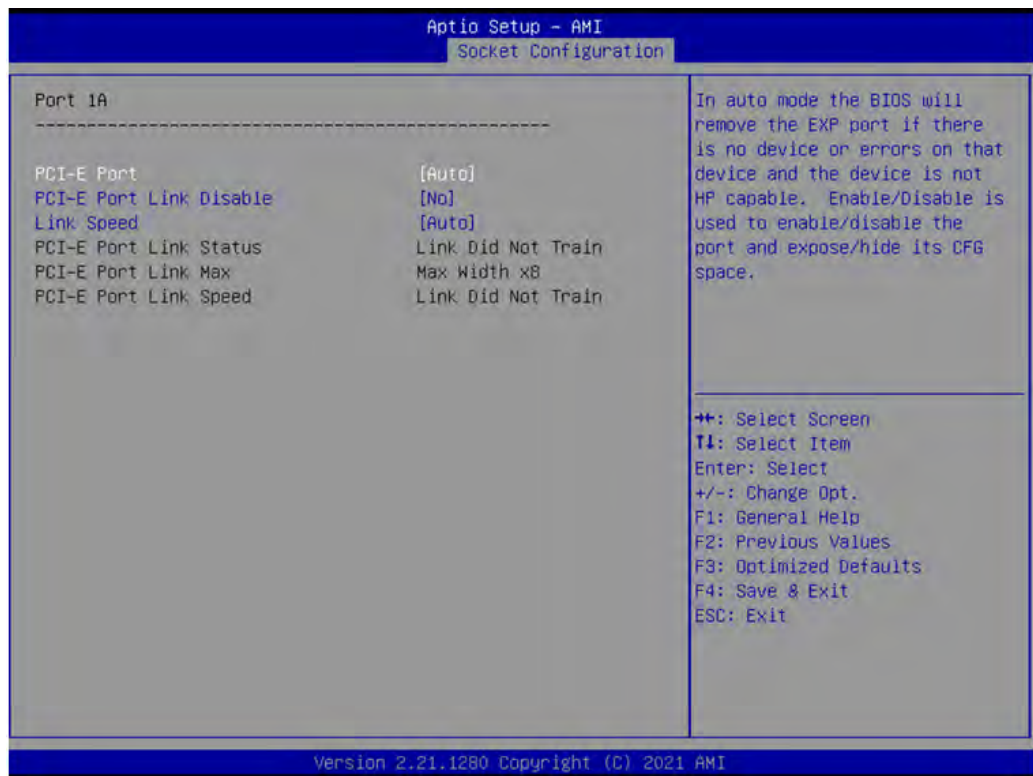
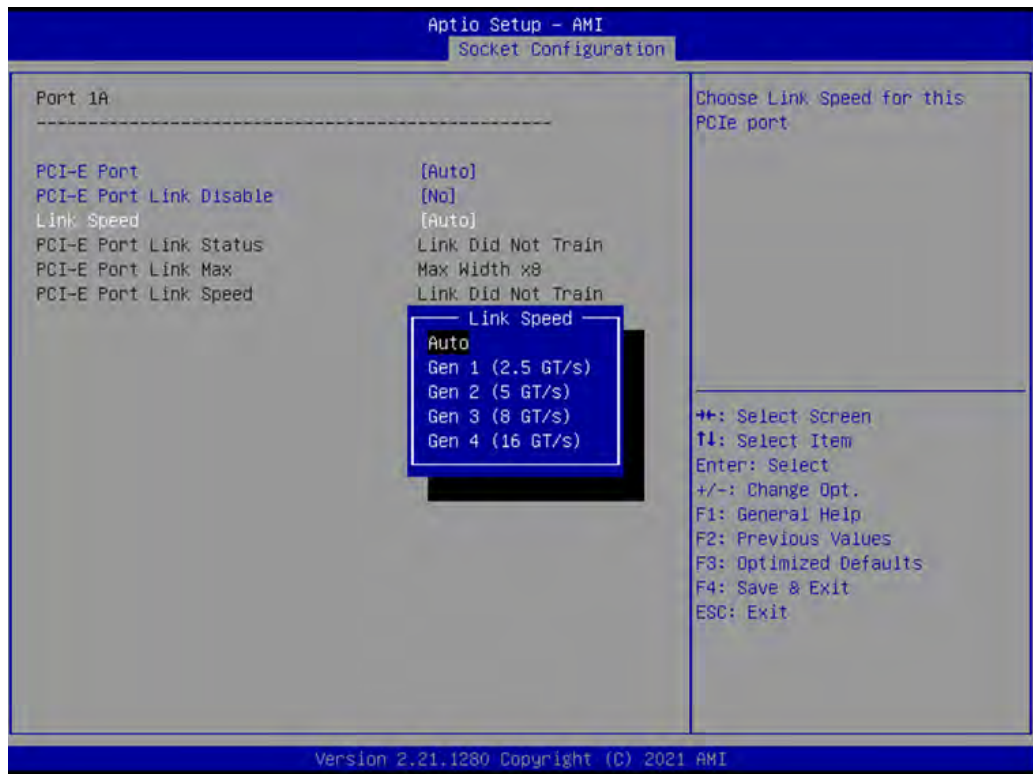



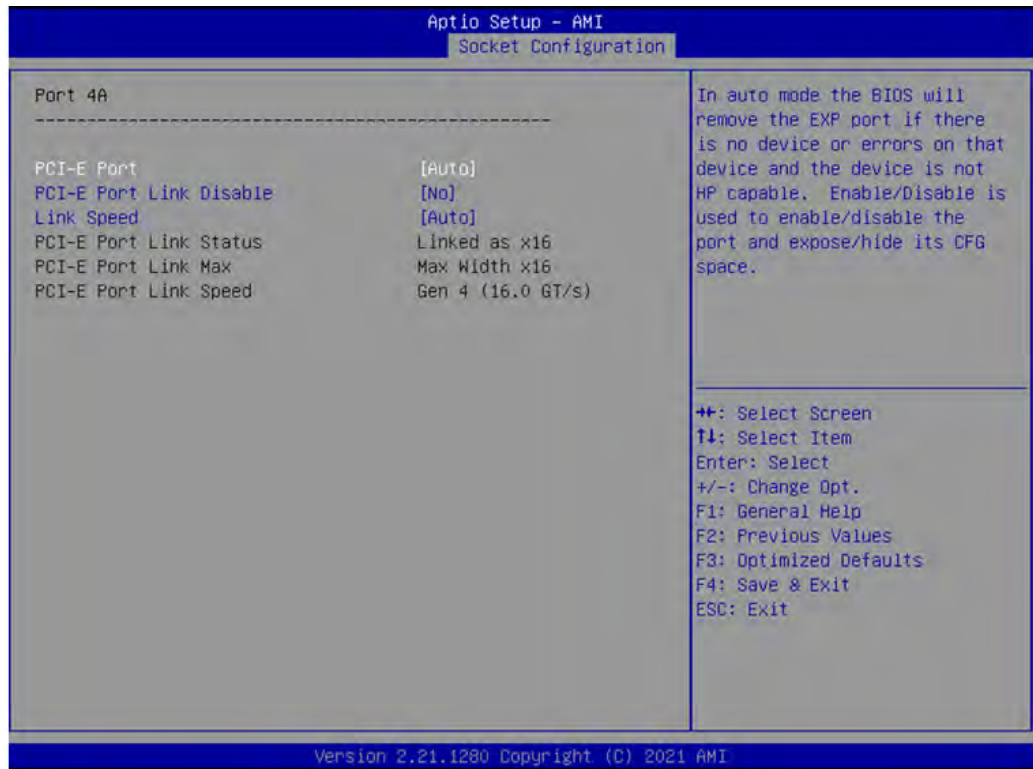



■ Intel VT for Directed I/O (VT-d)

Enable or disable Intel Virtualization Technology for Directed I/O.



- **Intel VMD Technology**

Enable or disable Intel Volume Management Device Technology.

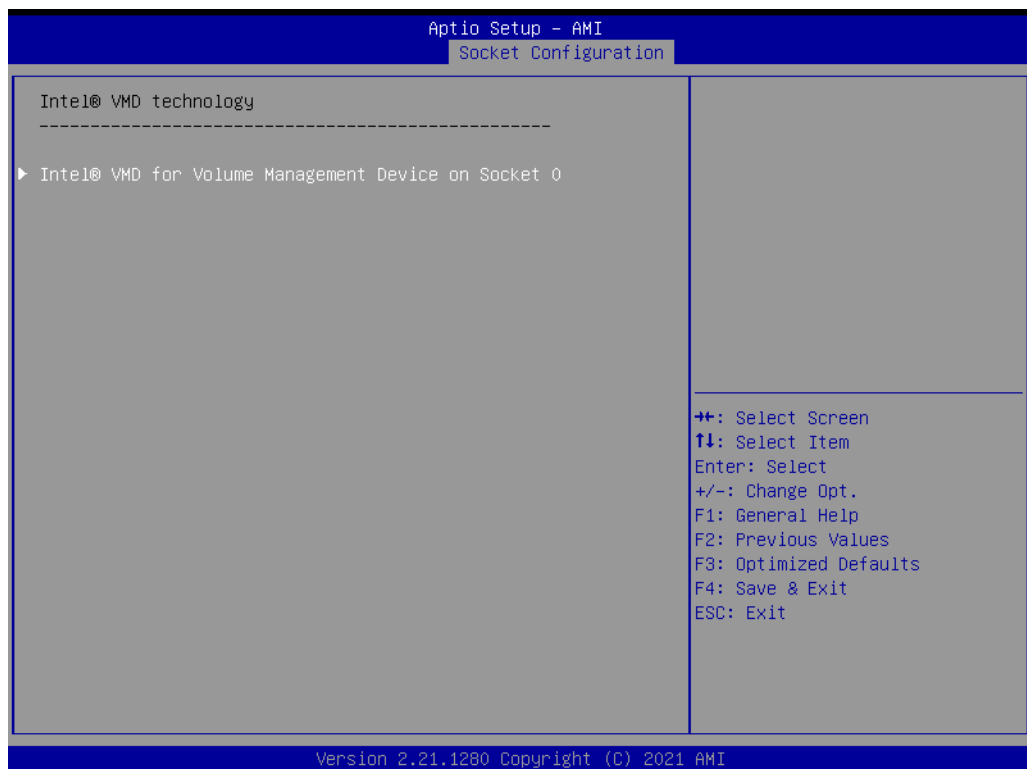

- **PCIe Hot Plug**

Enable or disable PCIe hot plug for Intel VROC, while using Intel VROC, please enable this item.

- **PCI-E ASPM Support (Global)**

Set the ASPM level to Disable, Per-Port or L1 state only.

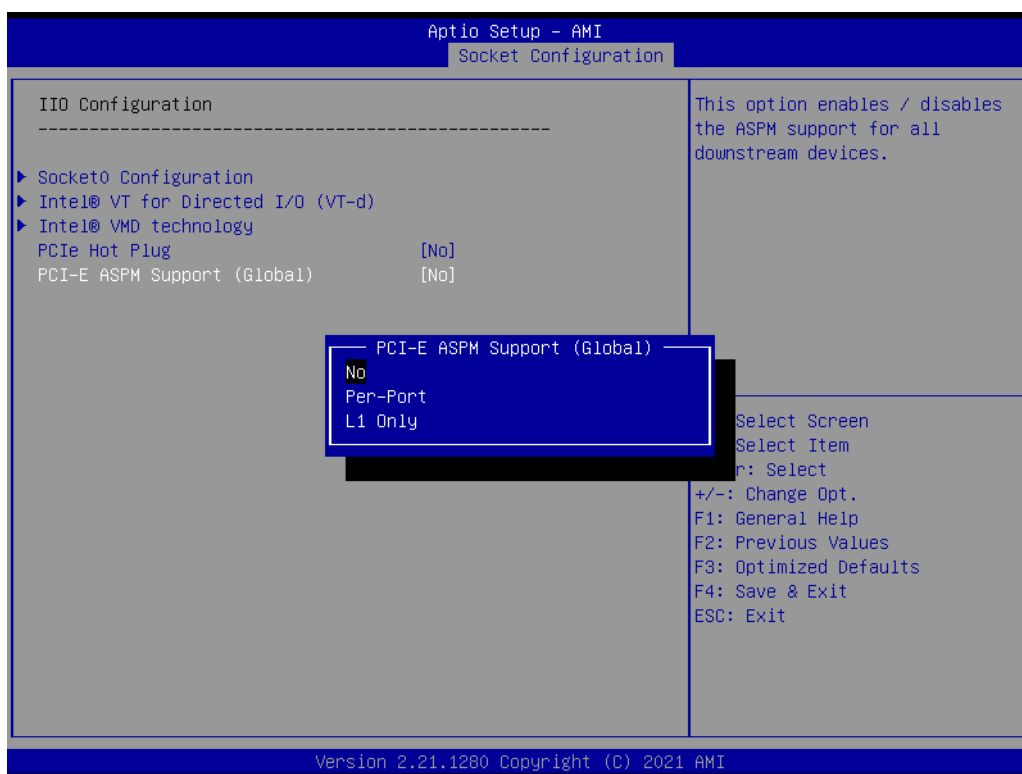

3.2.4.5 Advanced Power Management Configuration

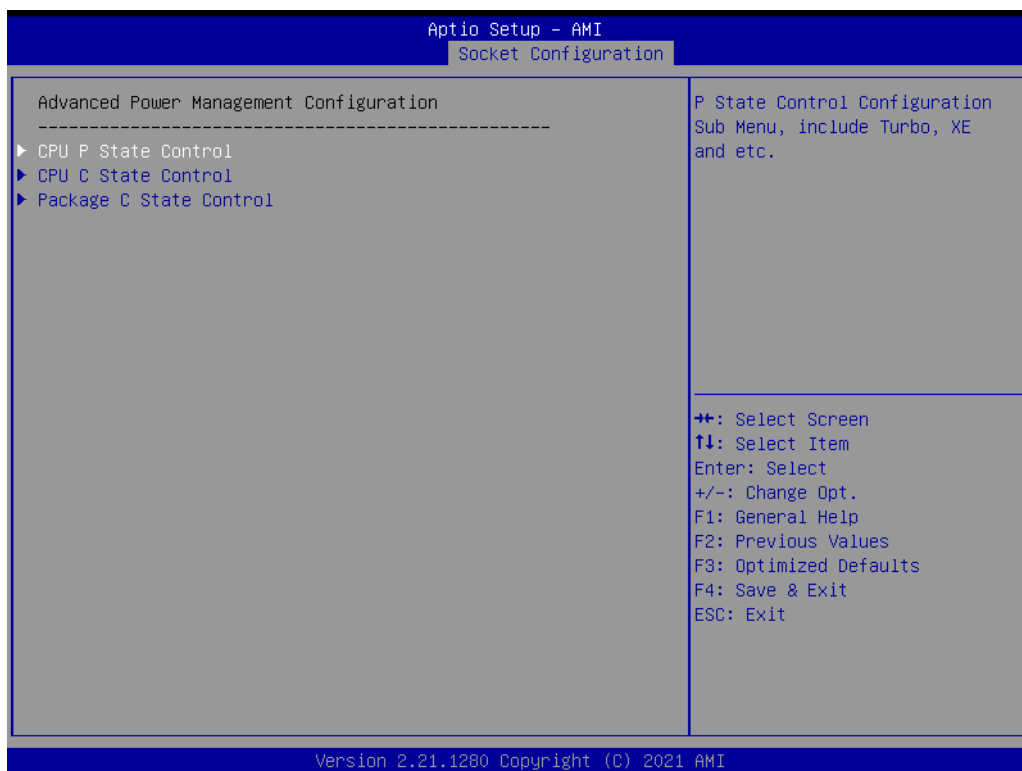

■ CPU P State Control

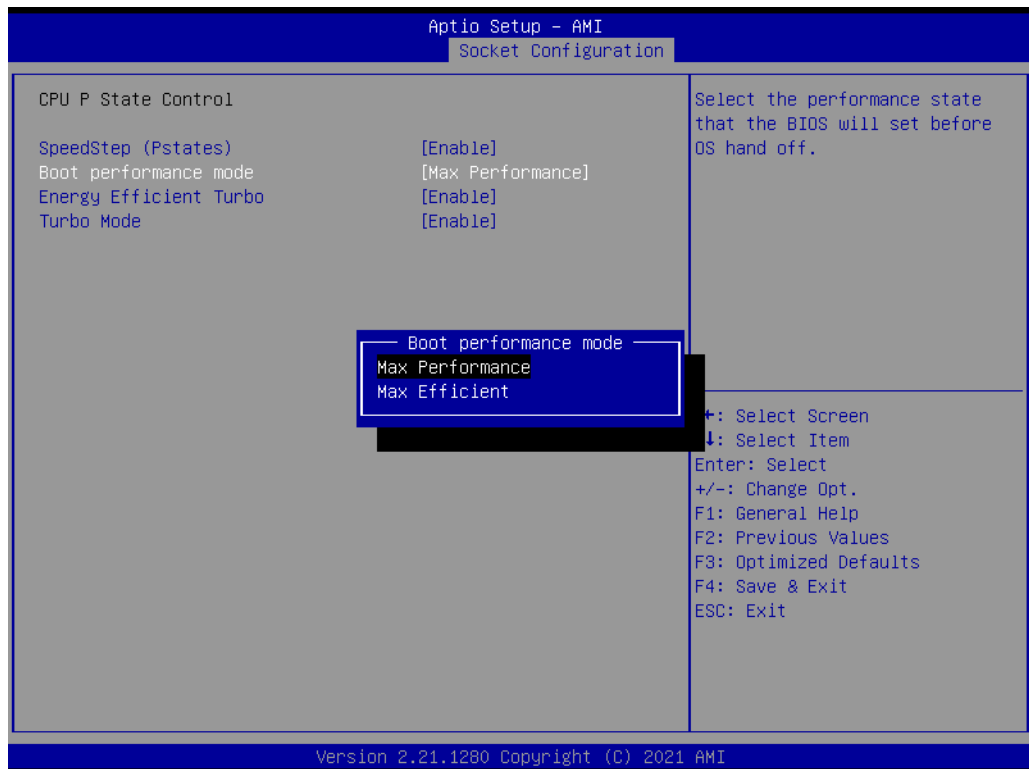
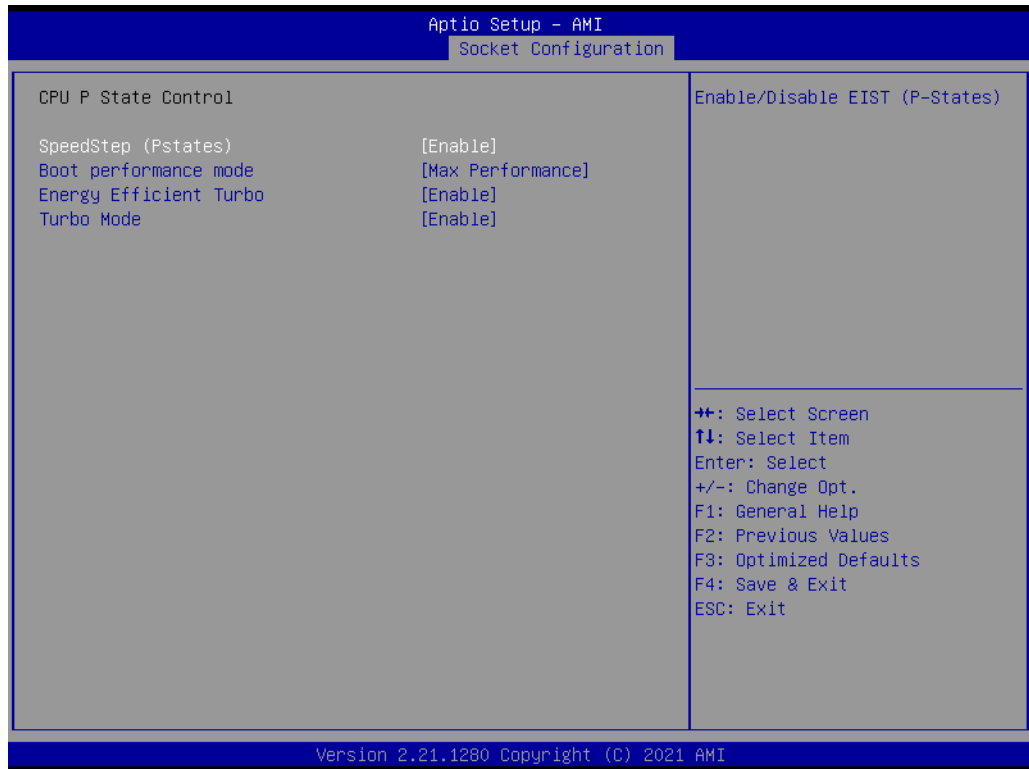

■ CPU C State Control



■ Package C State Control

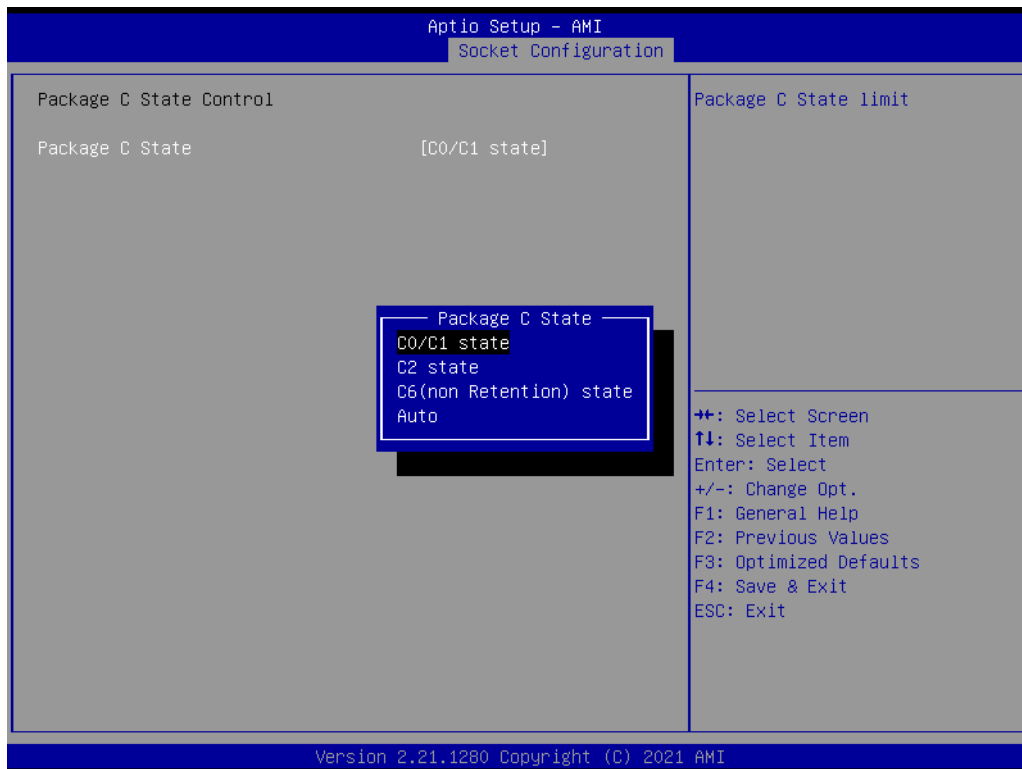

3.2.5 Server Management

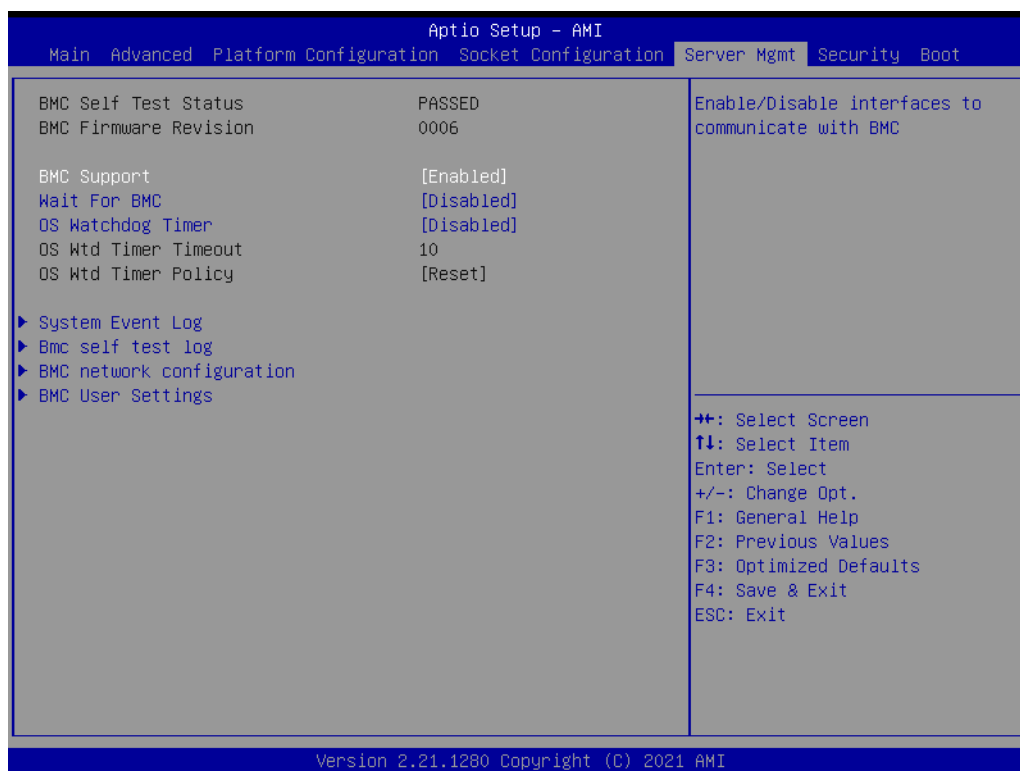

- **BMC Support**
Enable or disable interfaces to communicate with BMC.
- **Wait for BMC**
If enabled, motherboard will wait 30 ~ 60 seconds until BMC module boots up completely. After that, the normal BIOS post screen will be displayed.
If disabled, motherboard will not wait for BMC module's response.
- **OS Watchdog Timer**
If enabled, starts a BIOS timer which can only be shut off by Management Software after the OS loads.

3.2.5.1 System Event Log

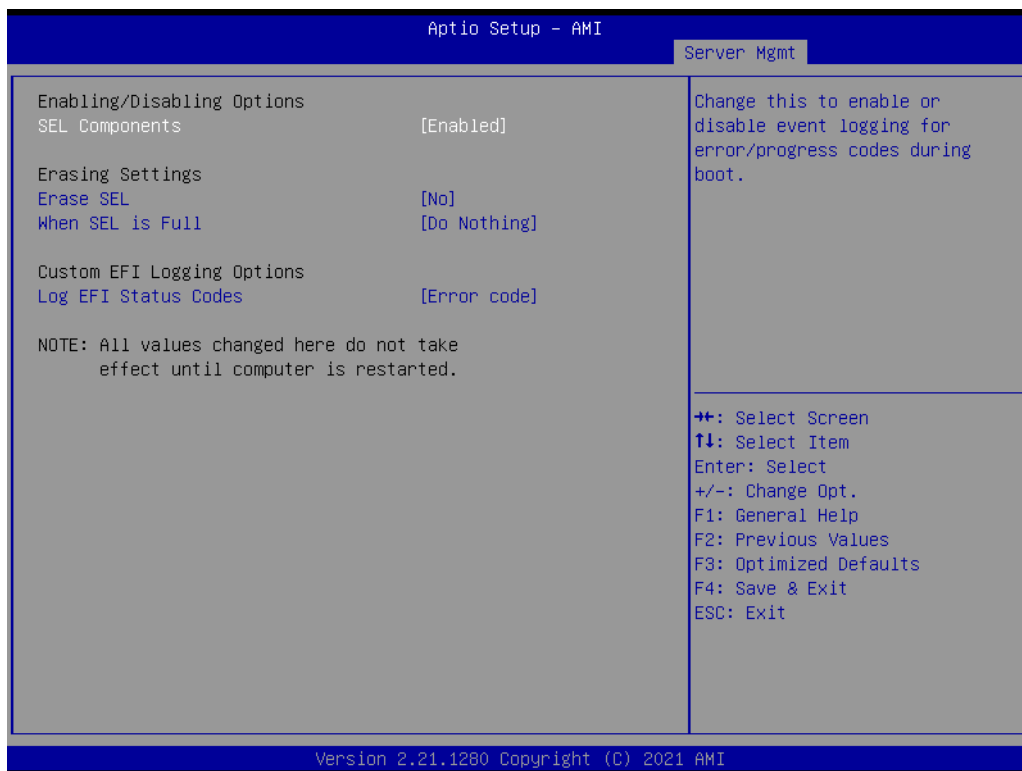

- **SEL Components**
Enable/Disable all features of system event logging during boot.
- **Erase SEL**
Choose options for erasing SEL.
- **When SEL is Full**
Choose options for reactions to a full SEL.
- **Log EFI Status Codes**
Disable the logging of EFI status codes or log only error code or only progress code or both.

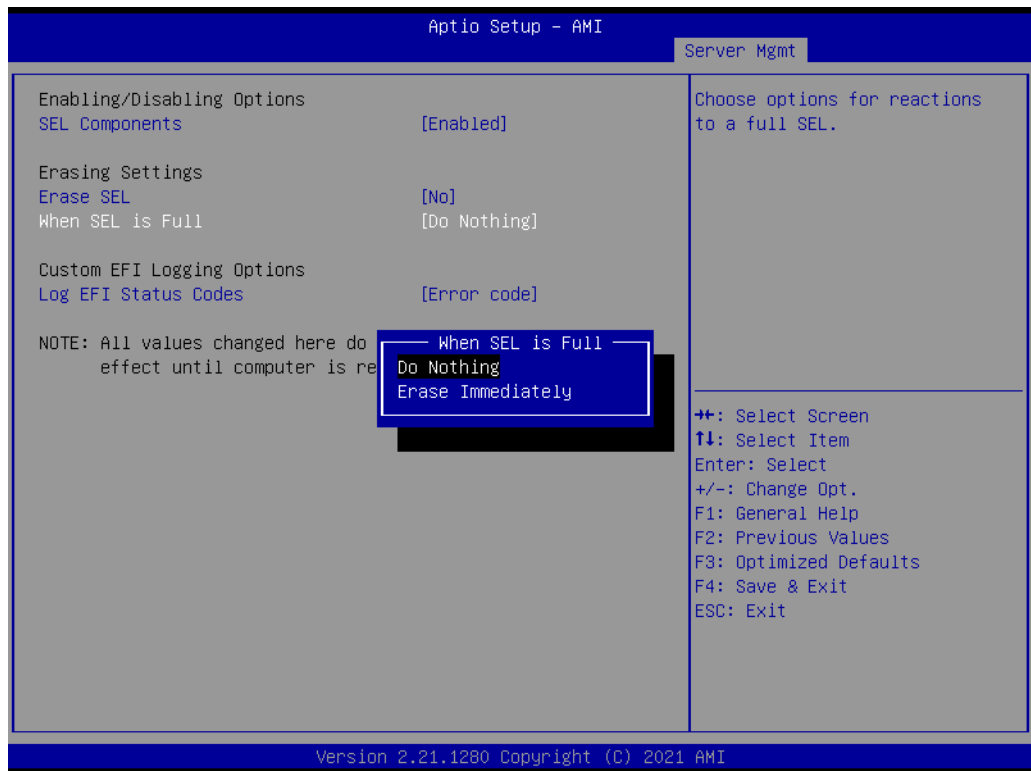
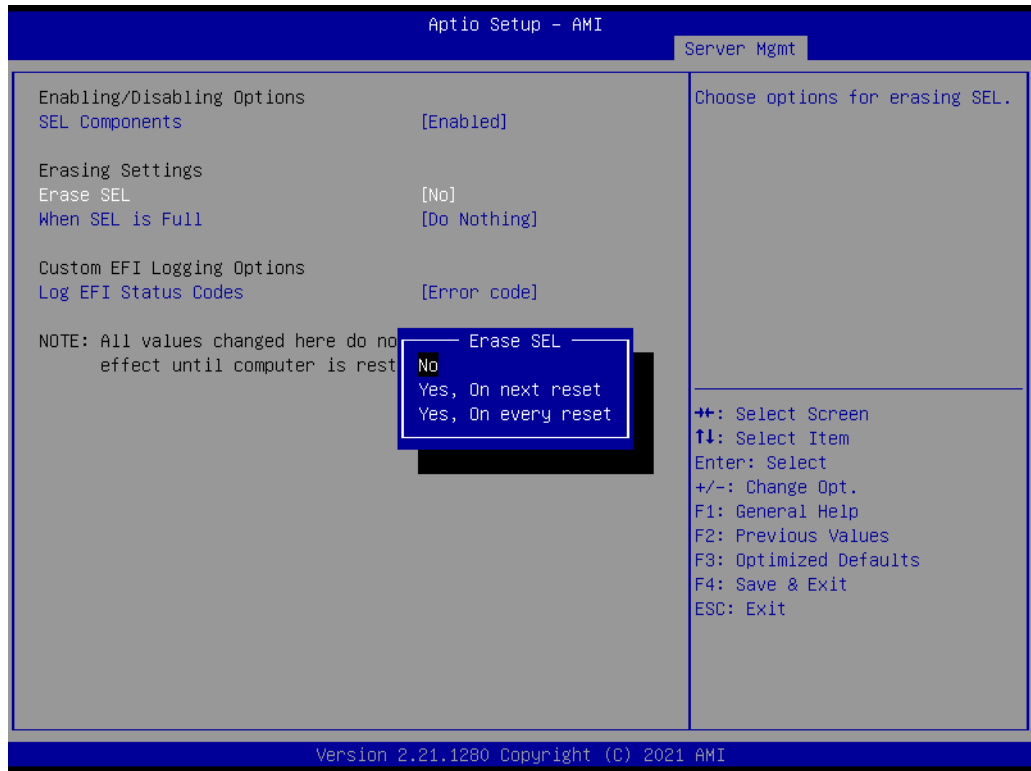

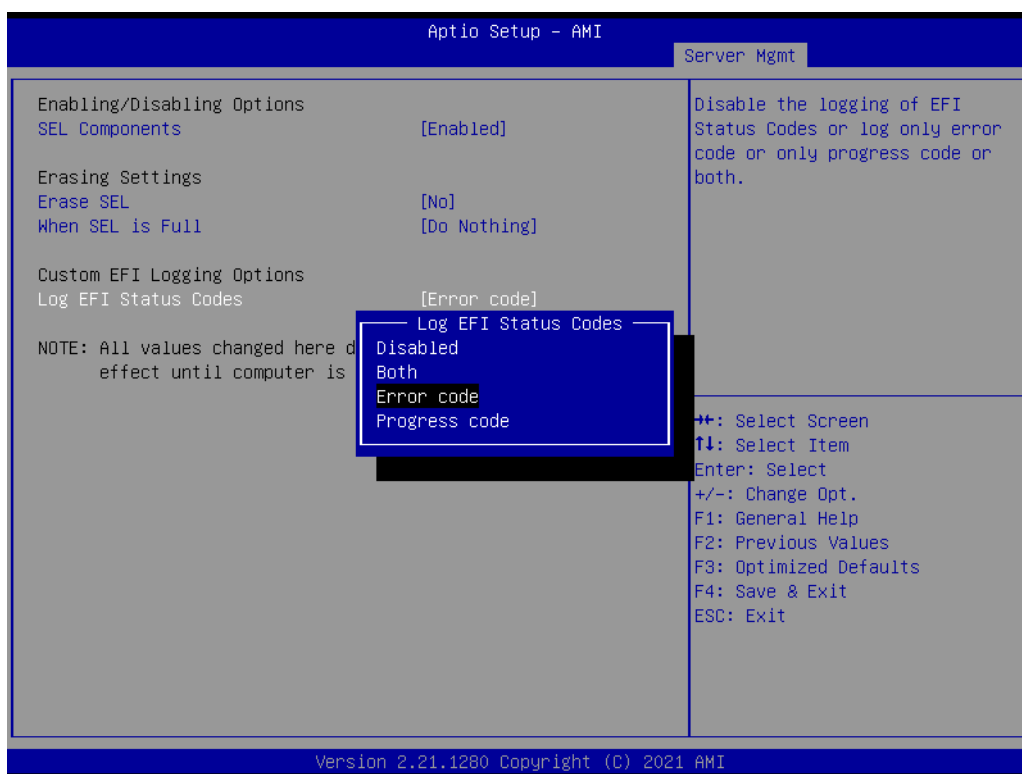

3.2.5.2 BMC Self Test Log

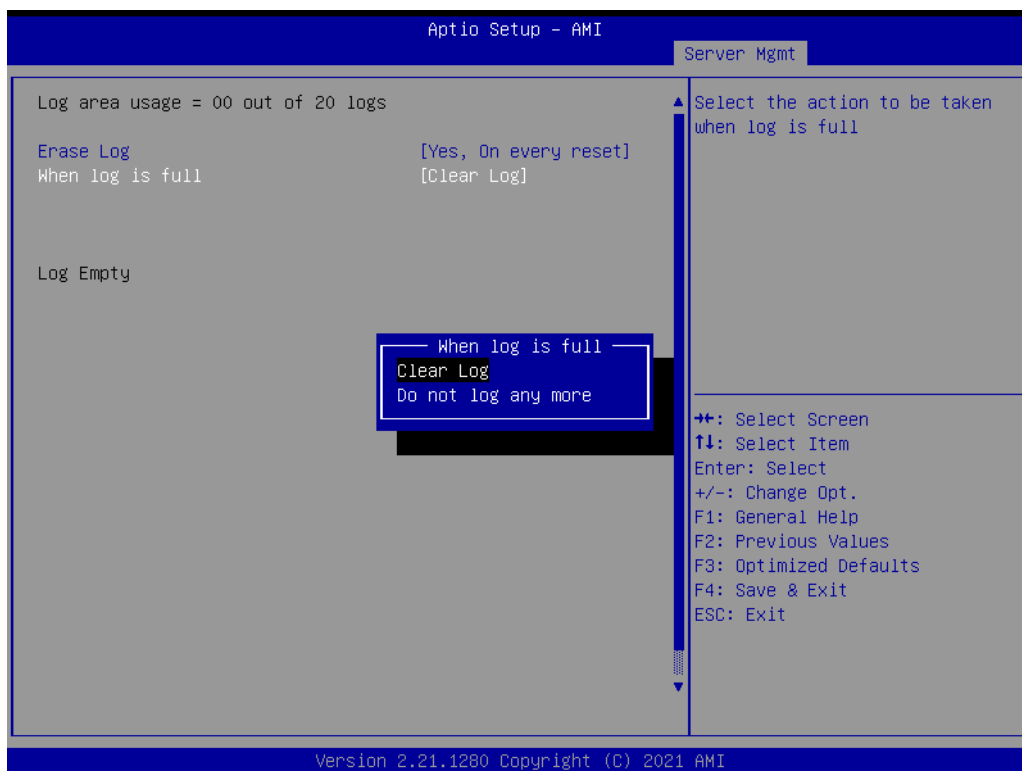

- **Erase Log**
Erase log options.
- **When Log is Full**
Select the action to be taken when log is full.

3.2.5.3 BMC Network Configuration

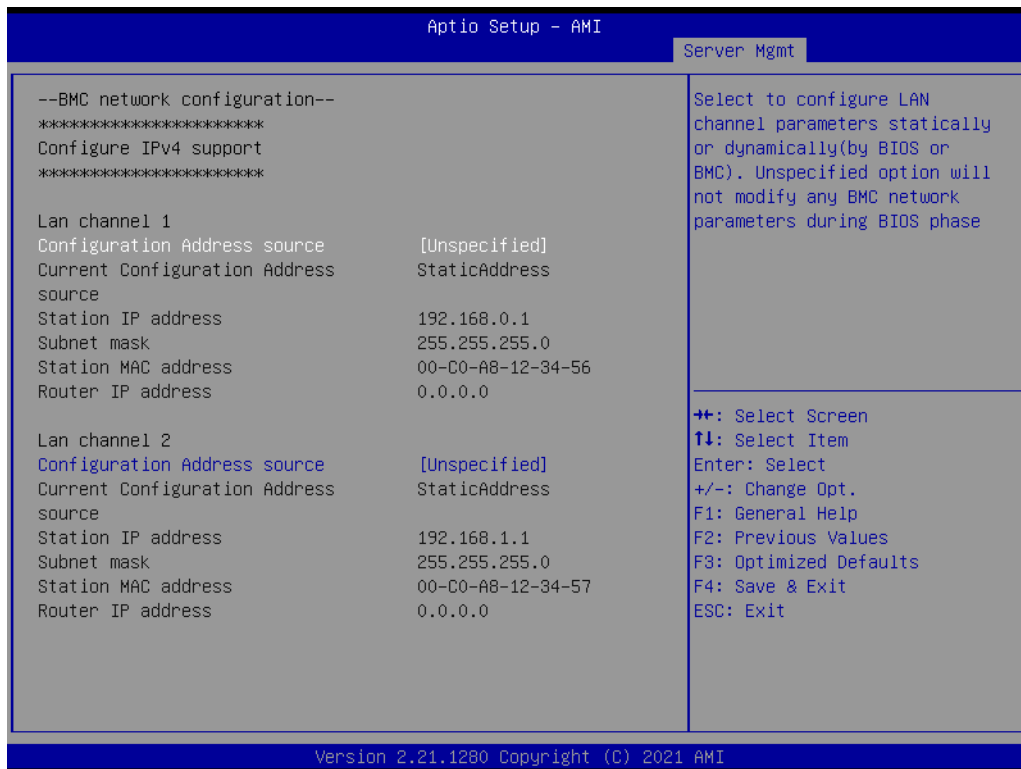

- Configuration Address Source**
 Select to configure LAN channel parameters statically or dynamically (by BMC). Unspecified option will not modify any BMC network parameters during BIOS phase.

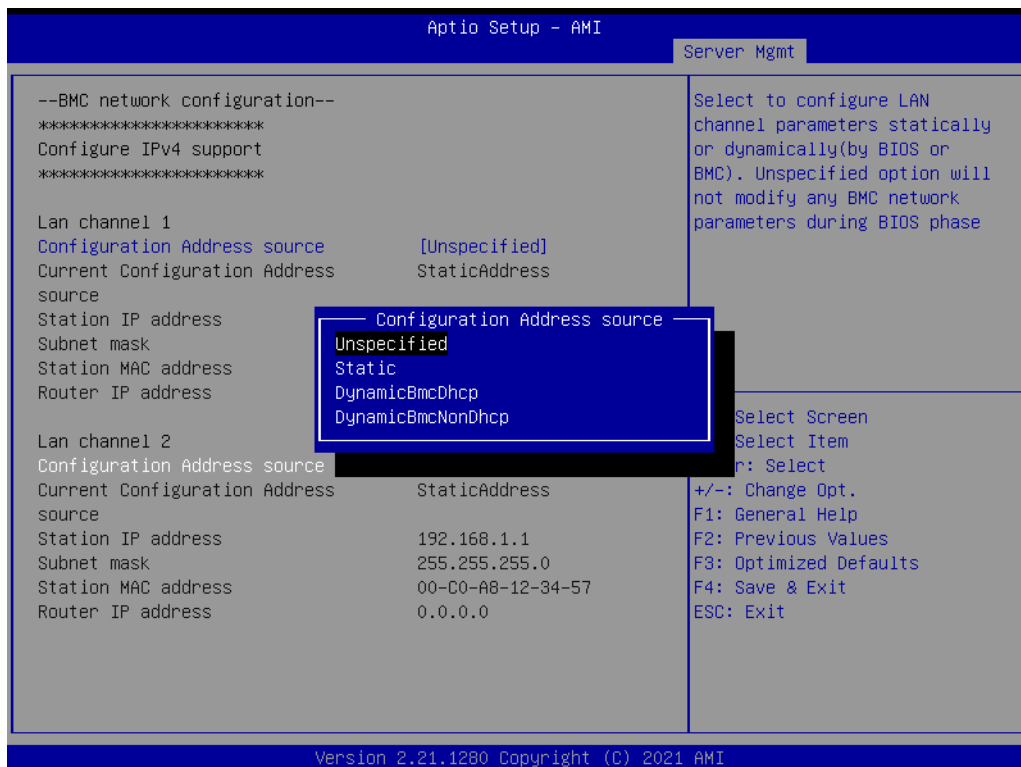

3.2.5.4 BMC User Settings

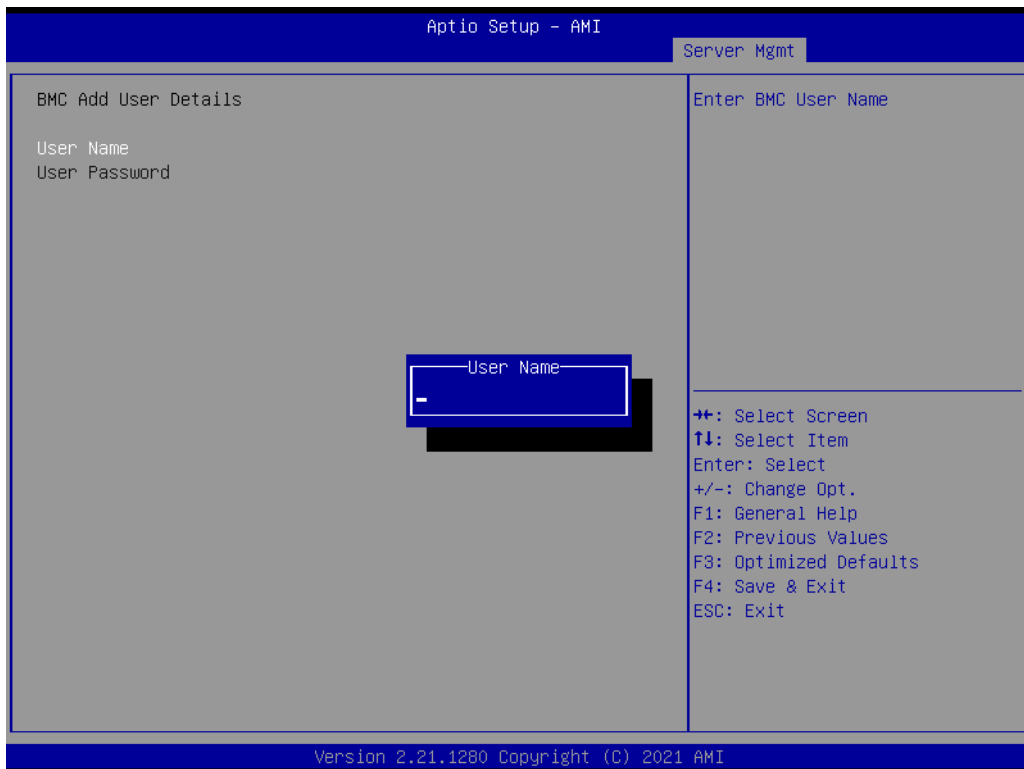
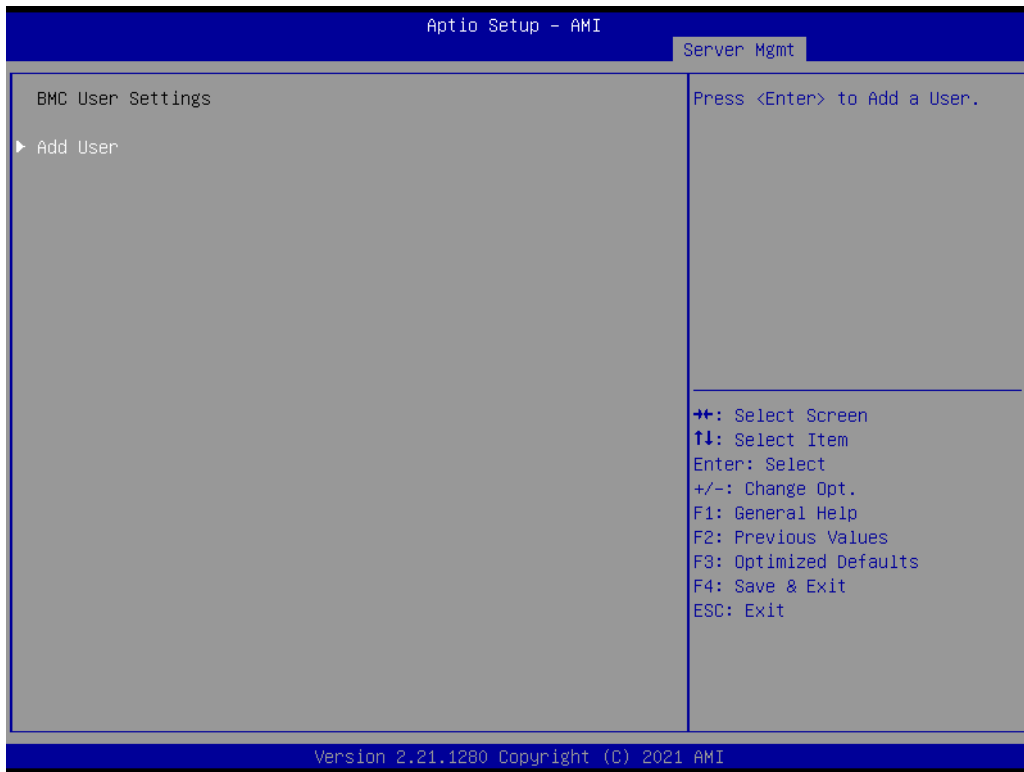

3.2.6 Security

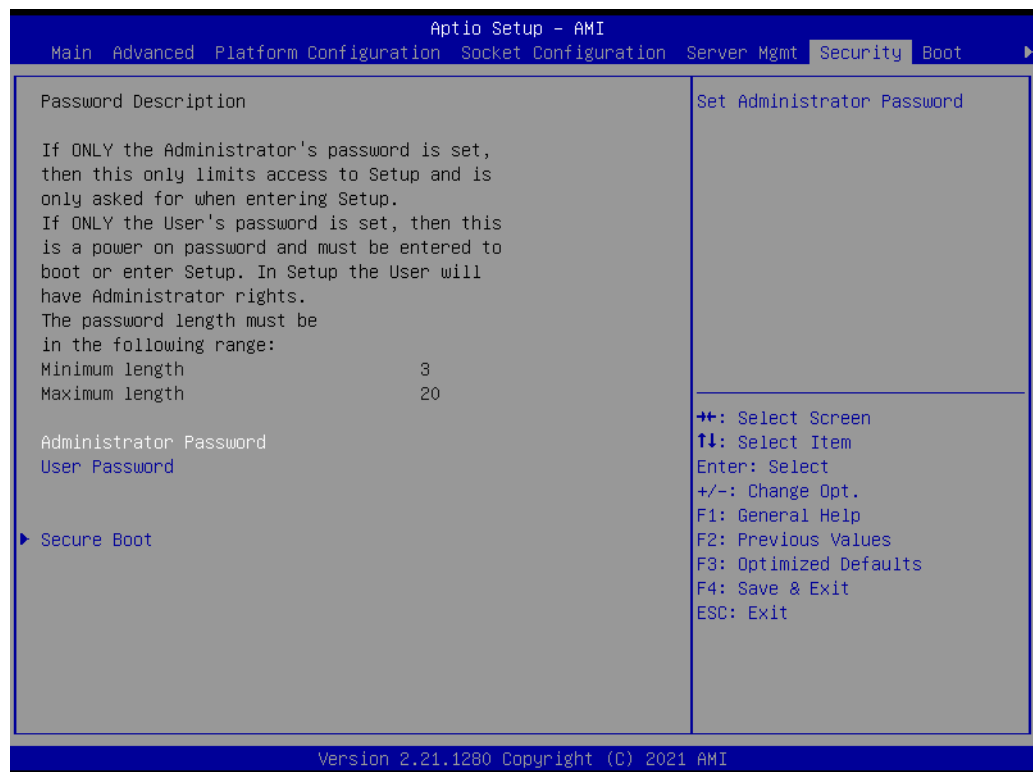



Note! *With AC power & Battery. Short CMOS1 Jumper:*



Date/Time & Password: Keep

Setting: reset to default

AC power and CMOS battery are removed. Short CMOS1 Jumper:

Date/Time: reset to default

Password: Keep

Setting: reset to default

■ Secure Boot



- **Secure Boot**
Secure Boot feature is active if Secure Boot is Enabled. Platform Key (PK) is enrolled and the System is in User mode. The mode change requires platform reset.
- **Secure Boot Mode**
Secure Boot mode options.

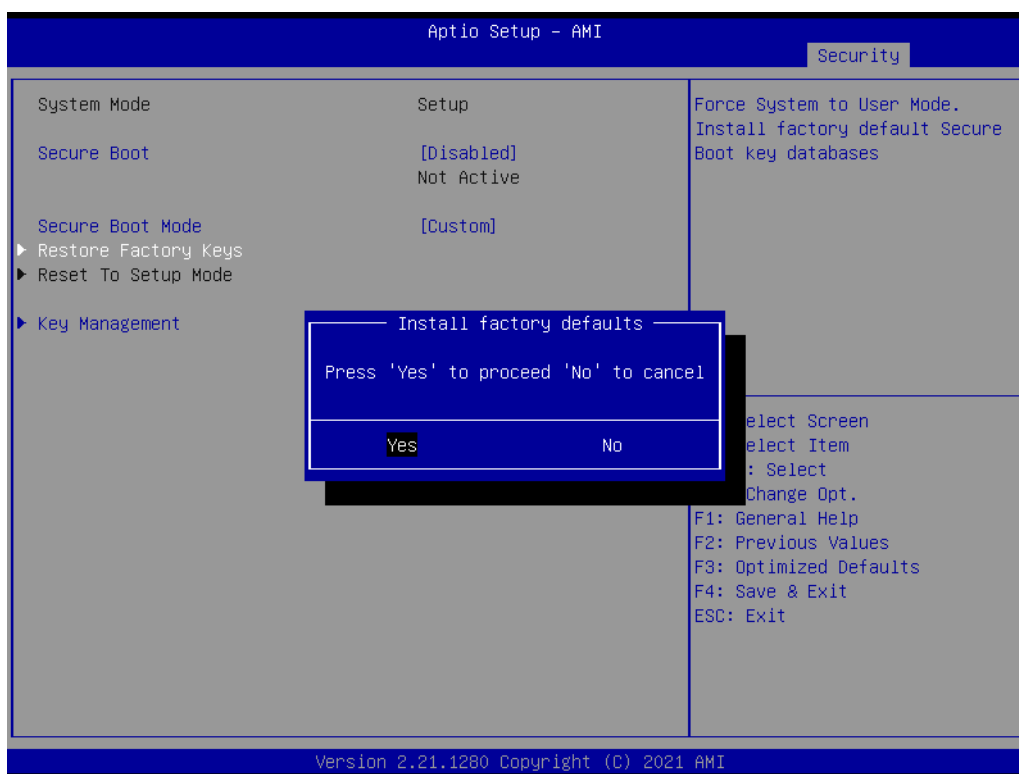

- **Restore Factory Keys**
Force System to User Mode.

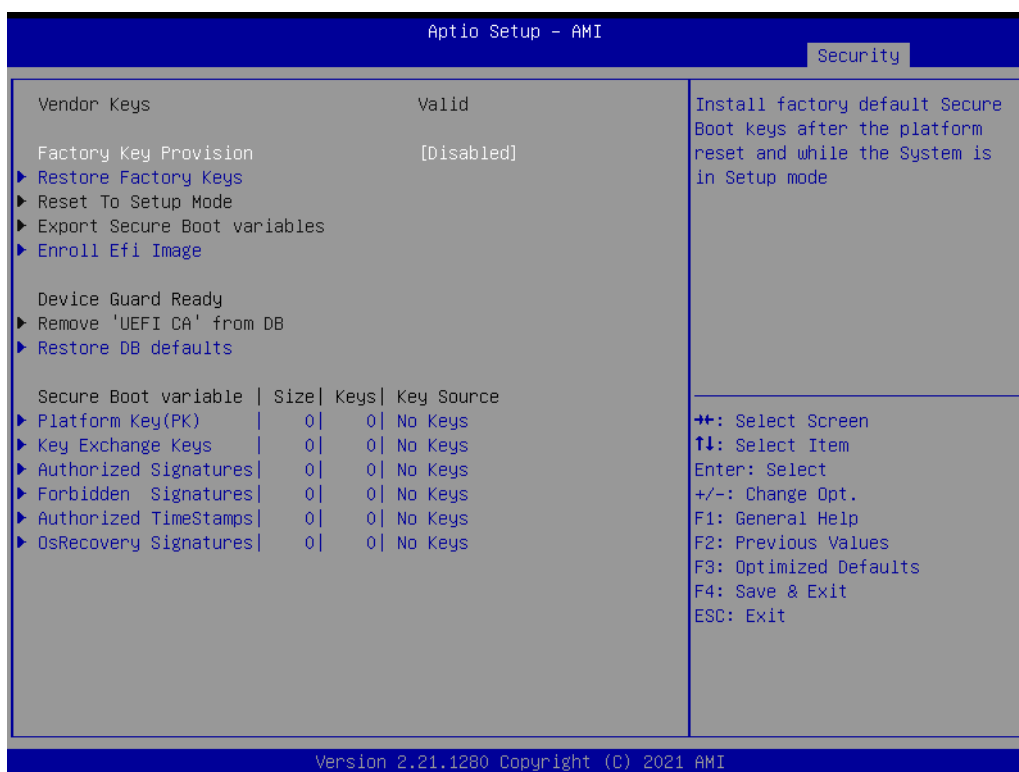

- **Key Management**
Enables expert users to modify Secure Boot Policy variables without full authentication.

3.2.7 Boot

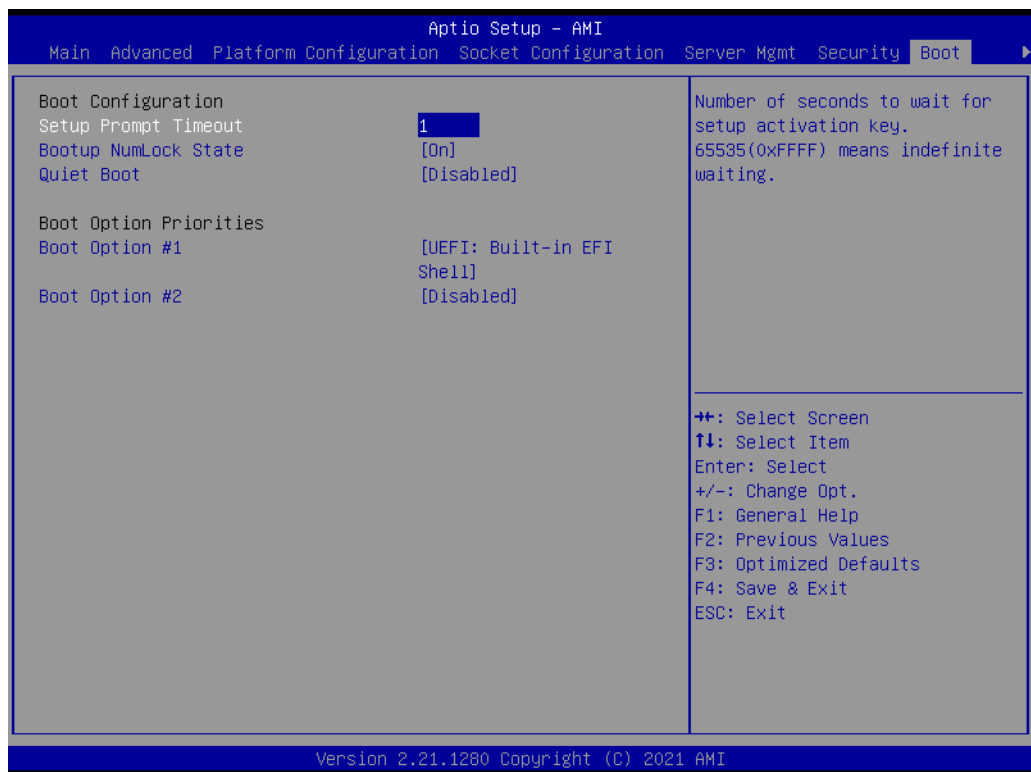

- **Setup Prompt Timeout**
Number of seconds to wait for setup activation key.
- **Bootup NumLock State**
Select the keyboard NumLock state as “On” or “Off”.
- **Quiet Boot**
Enable or disable quiet boot option.
- **Boot Option Priorities**
Sets the system boot priorities.

3.2.8 Save & Exit



- **Save Changes and Exit**
Exit system setup after saving the changes.
- **Discard Changes and Exit**
Exit system setup without saving any changes.
- **Save Changes and Reset**
Reset the system after saving changes.
- **Discard Changes and Reset**
Reset system setup without saving any changes.
- **Save Changes**
Save changes done so far to any of the setup options.
- **Discard Changes**
Discard changes done so far to any of the setup options.
- **Restore Defaults**
Restore/Load default values for all the setup options.
- **Save as User Defaults**
Save the changes done so far as user defaults.
- **Restore User Defaults**
Restore the user defaults to all the setup options.
- **Boot Override**

Chapter 4

Chipset Software
Installation Utility

4.1 Before Beginning

To facilitate the installation of the enhanced display drivers and utility software, read the instructions in this chapter carefully. The drivers for the ASMB-976 are available online for download from the Advantech support website.

Before beginning, it is important to note that most display drivers need to have the relevant software application already installed on the system prior to installing the enhanced display drivers. In addition, many of the installation procedures assume that you are familiar with both the relevant software applications and operating system commands. Review the relevant operating system commands and the pertinent sections of your application software's user manual before performing the installation.

4.2 Introduction

4.2.1 Main Menu

The Intel Chipset Software Installation (CSI) utility installs the Windows INF files that outline to the operating system how the chipset components will be configured. This is needed for the proper functioning of the following features:

- Core PCI PnP services
- Serial ATA interface support
- USB 1.1/2.0/3.2 gen1 support
- Identification of Intel chipset components in the Device Manager

Note! *The chipset driver is used for the following versions of Windows, and it has to be installed before installing all the other drivers:*



<i>Windows Server 2019 Standard</i>	<i>x64</i>
<i>Windows Server 2016 Standard</i>	<i>x64</i>
<i>Windows 10 Ultimate</i>	<i>x64</i>

Note! *It is necessary to update all the latest Microsoft hot fix files when using this OS.*



Chapter 5

Graphic Setup

5.1 Introduction

Install the ASPEED VGA driver to enable this function, which includes the following features:

- 32-bit 2D graphics engine on board for normal use.
- 64 MB RAM for this chip, the highest resolution is 1920x1200.

5.2 Windows Series Driver Setup

When the folder is displayed, navigate to the “Graphic” folder and click the executable file to complete the installation of the drivers for the OS that you need.

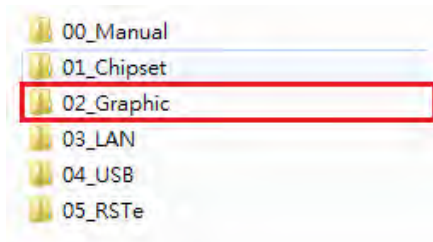

- Note!**
1. *If ASMB-976 Series carries an additional graphics card for VGA output, please set this additional graphic card as "major output" under the "Display properties" of OS.*
 2. *The WDDM driver can support for the following OS versions:*
 - Windows 8 x86/x64 version
 - Windows 8.1 x86/x64 version
 - Windows Server 2012 version (WHQL)
 - Windows Server 2012R2 version (WHQL)
 - Windows 10 x86/x64 version
 - Windows Server 2016 version (WHQL)
 3. *ASPEED Graphics WDDM Driver Limitation on Microsoft Windows OS.*
 - *It is non-WHQL certified driver because ASPEED VGA is a 2D VGA, it cannot meet the WHQL requirement of WDDM driver which requires 3D VGA function.*
 - *Because it is non-WHQL certified driver, it may meet some compatible issues with some specific applications.*

Chapter 6

LAN Configuration &
USB 3.0

6.1 LAN Configuration

6.1.1 Introduction

The ASMB-976T2 Series has two Gigabit Ethernet LAN connections via dedicated PCI Express x1 lanes: GbE LAN1 - Intel I210; GbE LAN2 - I210; two 10G Base-T LAN connectors LAN3 and LAN4 - Intel X550 PHY. They eliminate bottlenecks of network data flow and incorporate Gigabit Ethernet at 10 Gbps.

6.1.2 Features

- 10/100/1000&10G Base-T Ethernet controller
- 10/100/1000&10G Base-T triple-speed MAC
- Full duplex at 10/100/1000 Mbps or 10 Gbps and half duplex at 10/100/1000 Mbps
- Wake-on-LAN (WOL) support
- PCIe x1 host and PHY interface

6.1.3 Installation

The integrated Intel gigabit Ethernet controller supports all major network operating systems. However, the installation procedure varies with different operating systems. In the following sections, refer to the one that provides the driver setup procedure for the operating system you are using.

6.1.4 Windows Series Driver Setup (LAN)

1. Select folder "03_LAN" then click the proper LAN driver for the OS.

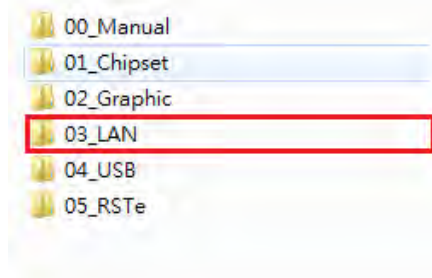

6.2 USB 3.2 gen1

6.2.1 Introduction

ASMB-976 offers nine USB 3.2 gen1 ports, two in rear side and seven via onboard header. The USB 3.2 gen1 could provide the bandwidth up to 500MB/s to shorter the time for data transmission.

6.2.2 Windows Series Driver Setup

Select folder "04_USB" then click the Setup.exe file for the installation.

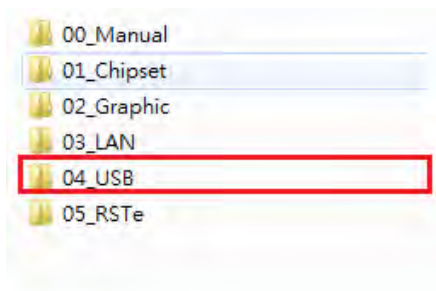

6.3 SATA & PCIe SSD RAID

Intel C621A PCH chip offers SATA & PCIe SSD RAID under Windows operating system.

Note! *1. Please visit the Intel download center for "Intel Rapid Storage Technology enterprise for Microsoft Windows Operating System Software User's Guide" file download.*



2. For the hotfix file download, please visit Microsoft website.

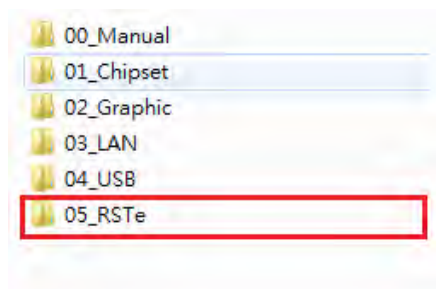

Appendix **A**

Programming the
Watchdog Timer

A.1 Watchdog Timer Overview

The ASMB-925 Series watchdog timer can be used to monitor system software operation and take corrective action if the software fails to function within the programmed period. This section describes the operation of the watchdog timer and how to program it. The watchdog timer is built in to the EC controller IT8528E. It provides the following functions for user programming:

- Can be enabled and disabled by user program
- Timer can be set from 1 to 255 seconds
- Generates an interrupt or resets signal if the software fails to reset the timer before time-out

A.2 Programming the Watchdog Timer

The I/O port address of the watchdog timer is as below:

Address	Description	
0x57	Event - Warm Reset: 0x04	
0x5E	Warm Reset Timer (High BYTE)	Based 100ms
0x5F	Warm Reset Timer (Low BYTE)	

Here is an example to step by step program the Watchdog Timer.

Step	Action	Description
00	Read 0x299 port	Clear I/O port
	Wait IBF clear	0x29A, BIT1, = 0
01	Write 0x89 to 0x29A	
	Wait IBF clear	0x29A, BIT1, = 0
02	Write 0x5E to 0x299 port	
	Wait IBF clear	0x29A, BIT1, = 0
03	Write 0x00 to 0x299 port	Set 10 sec (high byte)
	Wait IBF clear	0x29A, BIT1, = 0
04	Write 0x89 to 0x29A	
	Wait IBF clear	0x29A, BIT1, = 0
05	Write 0x5F to 0x299 port	
	Wait IBF clear	0x29A, BIT1, = 0
06	Write 0x64 to 0x299 port	Set 10 sec (low byte)
	Wait IBF clear	0x29A, BIT1, = 0
07	Write 0x89 to 0x29A	
	Wait IBF clear	0x29A, BIT1, = 0

08	Write 0x57 to 0x299 port	Watchdog Event
----	--------------------------	----------------

	Wait IBF clear	0x29A, BIT1, = 0
09	Write 0x04 to 0x299 port	(Warm) Reset event
	Wait IBF clear	0x29A, BIT1, = 0
10	Write 0x28 to 0x29A	Start watchdog
	Wait	1 ~ 9 sec
	Wait IBF clear	0x29A, BIT1, = 0
11	Write 0x29 to 0x29A	Stop watchdog
	Wait IBF clear	0x29A, BIT1, = 0
12	Go to Step 07	

Appendix **B**

I/O Pin Assignments

B.1 USB3.2 gen1 Header(USB3_34, USB3_56, USB3_78)

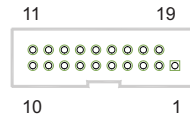

Table B.1: USB Header

Pin	Signal	Pin	Signal
1	+5 V	2	STDA_SSRX-
3	STDA_SSRX+	4	GND
5	STDA_SSRX-	6	STDA_SSRX+
7	GND	8	D-
9	D+	10	N/C (OC pin reserved)
11	D+	12	D-
13	GND	14	STDA_SSRX+
15	STDA_SSRX-	16	GND
17	STDA_SSRX+	18	STDA_SSRX-
19	+5 V	20	

B.2 VGA Connector (VGA1)

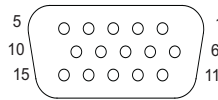

Table B.2: VGA Connector

Pin	Signal	Pin	Signal
1	RED	9	VCC
2	GREEN	10	GND
3	BLUE	11	N/C
4	N/C	12	SDT
5	GND	13	H-SYNC
6	GND	14	V-SYNC
7	GND	15	SCK
8	GND		

B.3 RS-232 Interface (COM2)

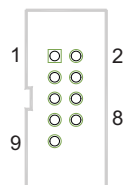

Table B.3: RS-232 Interface

Pin	Signal
1	DCD
2	RXD
3	TXD
4	DTR
5	GND
6	DSR
7	RTS
8	CTS
9	RI

B.4 External Keyboard Connector (KBMS1)

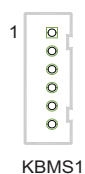

Table B.4: External Keyboard Connector

Pin	Signal
1	KB CLK
2	KB DATA
3	MS DATA
4	GND
5	VCC
6	MS CLK

B.5 CPU and System Fan Power Connector (CPUFAN0~1, SYSFAN0~SYSFAN6)

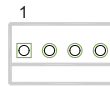

Table B.5: Fan Power Connector

Pin	Signal
1	GND
2	+12 V
3	TACH
4	PWM

B.6 Power LED (JFP3)

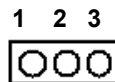

Table B.6: Power LED

Pin	Function
1	LED power (3.3 V)
2	N/C
3	Ground

B.7 External Speaker Connector (JFP2)

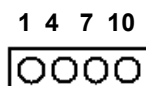

Table B.7: External Speaker Connector

Pin	Function
1	SPK+
4	N/C
7	BZ-
10	SPK-

B.8 Reset Connector (JFP1)



Table B.8: Reset Connector

Pin	Signal
9	RESET
12	GND

B.9 HDD LED Connector (JFP1)



Table B.9: HDD LED Connector

Pin	Signal
2	HDD_LED+
5	HDD_LED-

B.10 ATX Soft Power Switch (JFP1)



Table B.10: ATX Soft Power Switch

Pin	Signal
3	PWR-BTN
6	GND

B.11 Front Panel SMBus Connector (SMBUS1)

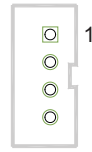

Table B.11: Front Panel SMBus Connector (SMBUS1)

Pin	Signal
1	+V5
2	SMB_CLK_RESUME
3	SMB_DATA_RESUME
4	GND

B.12 USB/LAN Ports (IPMI_LAN5_USB3_12)

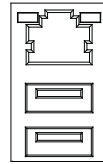

Table B.12: USB Port

Pin	Signal	Pin	Signal
1	VCC_DUAL	3	Data0+
2	Data0-	4	GND

Table B.13: Giga LAN 10/100/1000 Base-T RJ-45 Port

Pin	Signal	Pin	Signal
1	MID0+	4	MID2+
2	MID0-	5	MID2-
3	MID1+	7	MID3+
6	MID1-	8	MID3-

B.13 Audio Connector (HDAUD1)

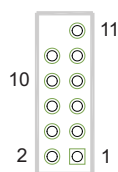

Table B.14: Front Panel Audio Connector

Pin	Signal	Pin	Signal
1	+5V_AUDIO	2	GND
3	ACZ_SYNC	4	ACZ_BITCLK
5	ACZ_SDOUT	6	ACZ_SDIN0
7	ACZ_SDIN1	8	ACZ_RST
9	+12V_AUDIO	10	GND
11	GND		

B.14 Alarm Board Connector (VOLT1)



Table B.15: Alarm Board Connector

Pin	Signal	Pin	Signal
1	5VSB	5	+5V
2	GND	6	+3.3V
3	GND	7	-12V
4	-5V	8	+12V

B.15 Case Open Connector (JCASE1)



Table B.16: Case Open Connector

Pin	Signal
1	CASEOP
2	GND

B.16 Front Panel LAN LED Connector (LANLED1)

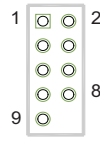

Table B.17: LAN LED Connector

Pin	Signal	Pin	Signal
1	LAN1_LED_ACT#	2	LAN2_LED_ACT#
3	+V3.3_AUX	4	+V3.3_AUX
5	LAN3_LED_ACT#	6	LAN4_LED_ACT#
7	+V3.3_AUX	8	+V3.3_AUX
9	NC		

B.17 SATA SGPIO (SGPIO1/SGPIO2)



Table B.18: SATA SGPIO Connector

Pin	Signal
1	SGPIO_SATA_CLOCK
2	N/C
3	SGPIO_SATA_LOAD
4	SGPIO_SATA_DATA0
5	SGPIO_SATA_DATA1

B.18 LPC Connector (LPC1)

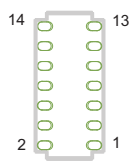

Table B.19: LPC Connector (LPC1)

Pin	Signal	Pin	Signal
1	CLK_24M_LPCCN	2	LPC_AD1
3	PLTRST_LPC	4	LPC_AD0
5	LPC_FRAME#	6	+3.3 V
7	LPC_AD3	8	GND
9	LPC_AD2	10	SMB_SCL_LPC
11	SERIRQ_PCH	12	SMB_SDA_LPC
13	+5V_AUX	14	+5V

B.19 Clear CMOS and Update ME Connector (JCMOS1, JME1)



Table B.20: Clear CMOS and Update ME Connector (JCMOS1, JME1)

Pin	Signal	Signal
	JCMOS1	JME1
1	N/C	N/C
2	RTC_RST_PCH	PCH_HDA_SDO
3	GND	V3.3_AUX

B.20 PMBUS Connector (PMBUS1)

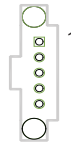

Table B.21: PMBUS Connector (PMBUS1)

Pin	Signal
1	SMB_SCL_PM
2	SMB_SDA_PM
3	SMB_ALERT_PM#
4	GND
5	+V3.3_AUX

B.21 GPIO Connector (GPIO1)

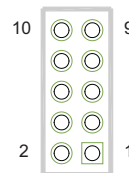

Table B.22: GPIO Connector (GPIO1)

Pin	Signal	Pin	Signal
1	EC_GPIO0	2	EC_GPIO4
3	EC_GPIO1	4	EC_GPIO5
5	EC_GPIO2	6	EC_GPIO6
7	EC_GPIO3	8	EC_GPIO7
9	+VCC_GPIO	10	GND

ADVANTECH

Enabling an Intelligent Planet

www.advantech.com

Please verify specifications before quoting. This guide is intended for reference purposes only.

All product specifications are subject to change without notice.

No part of this publication may be reproduced in any form or by any means, such as electronically, by photocopying, recording, or otherwise, without prior written permission from the publisher.

All brand and product names are trademarks or registered trademarks of their respective companies.

© Advantech Co., Ltd. 2022