



User Manual

AIR-150

Fanless Edge Intelligence System

ADVANTECH

Enabling an Intelligent Planet

Attention!

This product contains a hard copy of the Chinese user manual for China CCC certification purposes. A PDF of the English user manual is included on the accompanying CD. Please disregard the hard copy Chinese user manual if the product is not sold and/or installed in China.

Copyright

The documentation and the software included with this product are copyrighted 2023 by Advantech Co., Ltd. All rights are reserved. Advantech Co., Ltd. reserves the right to make improvements in the products described in this manual at any time without notice. No part of this manual may be reproduced, copied, translated or transmitted in any form or by any means without the prior written permission of Advantech Co., Ltd. Information provided in this manual is intended to be accurate and reliable. However, Advantech Co., Ltd. assumes no responsibility for its use, nor for any infringements of the rights of third parties, which may result from its use.

Acknowledgments

Award is a trademark of Award Software International, Inc VIA is a trademark of VIA Technologies, Inc.

IBM, PC/AT, PS/2 and VGA are trademarks of International Business Machines Corporation.

Intel[®] and Pentium[®] are trademarks of Intel Corporation Microsoft Windows[®] is a registered trademark of Microsoft Corp RTL is a trademark of Realtek Semi-Conductor Co., Ltd.

ESS is a trademark of ESS Technology, Inc.

UMC is a trademark of United Microelectronics Corporation SMI is a trademark of Silicon Motion, Inc.

Creative is a trademark of Creative Technology LTD CHRONTEL is a trademark of Chronitel Inc.

All other product names or trademarks are properties of their respective owners.

For more information about this or other Advantech products, visit our website at <http://www.advantech.com/>

https://www.advantech.com/products/fanless-embedded-computers/sub_1-2jkeuf

For technical support and customer service, visit our support website at <http://support.advantech.com.tw/support/>

Product Warranty (2 years)

Advantech warrants to you, the original purchaser, that each of its products will be free from defects in materials and workmanship for two years from the date of purchase.

This warranty does not apply to any products which have been repaired or altered by persons other than repair personnel authorized by Advantech, or which have been subject to misuse, abuse, accident or improper installation. Advantech assumes no liability under the terms of this warranty as a consequence of such events.

Because of Advantech's high quality-control standards and rigorous testing, most of our customers never need to use our repair service. If an Advantech product is defective, it will be repaired or replaced at no charge during the warranty period. For out-of-warranty repairs, you will be billed according to the cost of replacement materials, service time and freight. Please consult your dealer for more details.

If you think you have a defective product, follow these steps:

1. Collect all the information about the problem encountered. (For example, CPU speed, Advantech products used, other hardware and software used, etc.) Note anything abnormal and list any onscreen messages you get when the problem occurs.
2. Call your dealer and describe the problem. Please have your manual, product, and any helpful information readily available.
3. If your product is diagnosed as defective, obtain an RMA (return merchandise authorization) number from your dealer. This allows us to process your return more quickly.
4. Carefully pack the defective product, a fully-completed Repair and Replacement Order Card and a photocopy proof of purchase date (such as your sales receipt) in a shippable container. A product returned without proof of the purchase date is not eligible for warranty service.
5. Write the RMA number visibly on the outside of the package and ship it prepaid to your dealer.

Declaration of Conformity

FCC Class B

Note: This equipment has been tested and found to comply with the limits for a Class B digital device, pursuant to part 15 of the FCC Rules. These limits are designed to provide reasonable protection against harmful interference in a residential installation. This equipment generates, uses and can radiate radio frequency energy and, if not installed and used in accordance with the instructions, may cause harmful interference to radio communications. However, there is no guarantee that interference will not occur in a particular installation. If this equipment does cause harmful interference to radio or television reception, which can be determined by turning the equipment off and on, the user is encouraged to try to correct the interference by one or more of the following measures:

- Reorient or relocate the receiving antenna.
- Increase the separation between the equipment and receiver.
- Connect the equipment into an outlet on a circuit different from that to which the receiver is connected.
- Consult the dealer or an experienced radio/TV technician for help.

Technical Support and Assistance

1. Visit the Advantech website at <http://support.advantech.com> where you can find the latest information about the product.
2. Contact your distributor, sales representative, or Advantech's customer service center for technical support if you need additional assistance. Please have the following information ready before you call:
 - Product name and serial number
 - Description of your peripheral attachments
 - Description of your software (operating system, version, application software, etc.)
 - A complete description of the problem
 - The exact wording of any error messages

Warnings, Cautions and Notes

Warning! *Warnings indicate conditions, which if not observed, can cause personal injury!*



Caution! *Cautions are included to help you avoid damaging hardware or losing data. e.g.*



There is a danger of a new battery exploding if it is incorrectly installed. Do not attempt to recharge, force open, or heat the battery. Replace the battery only with the same or equivalent type recommended by the manufacturer. Discard used batteries according to the manufacturer's instructions.

Note! *Notes provide optional additional information.*



Document Feedback

To assist us in making improvements to this manual, we would welcome comments and constructive criticism. Please send all such comments in writing to: support@advantech.com

Safety Precaution - Static Electricity

Follow these simple precautions to protect yourself from harm and the products from damage.

- To avoid electrical shock, always disconnect the power from your PC chassis before you work on it. Don't touch any components on the CPU card or other cards while the PC is on.
- Disconnect power before making any configuration changes. The sudden rush of power as you connect a jumper or install a card may damage sensitive electronic components.

Safety Instructions

1. Read these safety instructions carefully.
2. Retain this user manual for future reference.
3. Disconnect the equipment from all AC outlets before cleaning. Use only a damp cloth for cleaning. Do not use liquid or sprayed detergent.
4. For pluggable equipment, the power outlet should be near the equipment and easily accessible.
5. Protect the equipment from humidity.
6. Place the equipment on a reliable surface during installation. Dropping or letting the equipment fall may cause damage.
7. The openings on the enclosure are for air convection and protect the equipment from overheating. Do not cover the openings.
8. By means of a power cord connected to a socket-outlet with earthing connection.
9. Position the power cord away from high-traffic areas. Do not place anything over the power cord.
10. All cautions and warnings on the equipment should be noted.
11. If the equipment is not used for a long time, disconnect the equipment from the power source to avoid damage from transient over-voltage.
12. Never pour liquid into an opening as this can cause fire or electrical shock.
13. Never open the equipment. For safety reasons, only qualified service personnel should open the equipment.
14. If one of the following occurs, have the equipment checked by service personnel:
 - The power cord or plug is damaged.
 - Liquid has penetrated into the equipment.
 - The equipment has been exposed to moisture.
 - The equipment is malfunctioning or does not operate according to the user manual.
 - The equipment has been dropped and damaged.
 - The equipment shows obvious signs of breakage.
15. Do not leave the equipment in an environment with a storage temperature of below $-40\text{ }^{\circ}\text{C}$ ($-40\text{ }^{\circ}\text{F}$) or above $85\text{ }^{\circ}\text{C}$ ($185\text{ }^{\circ}\text{F}$) as this may cause damage. The equipment should be stored in a controlled environment.
16. Any unverified component may cause unexpected damage. To ensure correct installation, always use the components (e.g., screws) provided in the accessory box.
17. **CAUTION:** The equipment is equipped with a battery-powered real-time clock circuit. There is a risk of explosion if a battery is incorrectly replaced. Replace only with same or equivalent type as recommended by the manufacturer. Discard all used batteries according to the manufacturer's instructions.
18. Always disconnect the power cord from the chassis before manually handling the hardware. Do not implement connections or configuration changes while the device is powered on. Sudden power surges may damage sensitive electronic components.
19. In accordance with IEC 704-1:1982 specifications, the sound pressure level at the operator's position does not exceed 70 dB (A).
20. The equipment should only be installed in a restricted access area.
21. **DISCLAIMER:** These instructions are provided according to IEC 704-1 specifications. Advantech disclaims all responsibility for the accuracy of any statements contained herein.

Consignes de Sécurité

1. Veuillez lire attentivement ces instructions de sécurité.
2. Veuillez conserver ce manuel de l'utilisateur pour référence ultérieure.
3. Veuillez débrancher cet équipement de la prise secteur avant le nettoyage. Utilisez un chiffon humide. Ne pas utiliser de détergent liquide ou pulvérisé pour le nettoyage. Utilisez une feuille ou un chiffon humide pour le nettoyage.
4. Pour les équipements enfichables, la prise de courant doit être à proximité de l'équipement et doit être facilement accessible.
5. S'il vous plaît garder cet équipement de l'humidité.
6. Posez cet équipement sur une surface fiable lors de l'installation. Une chute ou une chute pourrait causer des blessures.
7. Les ouvertures sur le boîtier sont destinées à la convection d'air, protégeant ainsi l'équipement de la surchauffe. **NE COUVREZ PAS LES OUVERTURES.**
8. Au moyen d'un cordon d'alimentation connecté à une prise de courant avec mise à la terre.
9. Placez le cordon d'alimentation de sorte que personne ne puisse marcher dessus. Ne placez rien sur le cordon d'alimentation.
10. Tous les avertissements et mises en garde sur l'équipement doivent être notés.
11. Si l'appareil n'est pas utilisé pendant une longue période, débranchez-le du secteur pour ne pas être endommagé par une surtension transitoire.
12. Ne jamais verser de liquide dans les ouvertures de ventilation; Cela pourrait provoquer un incendie ou un choc électrique.
13. N'ouvrez jamais l'équipement. Pour des raisons de sécurité, seul le personnel de maintenance qualifié doit ouvrir l'équipement.
14. Si l'une des situations suivantes se présente, faites vérifier le matériel par le personnel de service:
 - Le cordon d'alimentation ou la fiche est endommagé
 - Un liquide a pénétré dans l'appareil
 - L'équipement a été exposé à l'humidité
 - L'équipement ne fonctionne pas bien ou vous ne pouvez pas le faire fonctionner conformément au manuel d'utilisation
 - Equipment L'équipement est tombé et a été endommagé
 - Equipment L'équipement présente des signes évidents de rupture
15. Ne laissez pas cet équipement dans un environnement où la température de stockage peut être inférieure à -40 °C (-40 °F) ou supérieure à 85 °C (185 °F). Cela pourrait endommager l'équipement. L'équipement doit être dans un environnement contrôlé.
16. Tout composant non vérifié peut causer des dommages inattendus. Pour garantir une installation correcte, veuillez toujours utiliser les composants (ex. Vis) fournis avec la boîte d'accessoires.
17. **ATTENTION:** L'ordinateur est équipé d'un circuit d'horloge temps réel alimenté par batterie. Il y a un risque d'explosion si la batterie est remplacée de manière incorrecte. Remplacez uniquement avec le même type ou un type équivalent recommandé par le fabricant. Jetez les piles usagées conformément aux instructions du fabricant.
18. Débranchez toujours complètement le cordon d'alimentation de votre châssis lorsque vous utilisez du matériel. Ne faites pas de connexion quand l'appareil est sous tension. Les composants électroniques sensibles peuvent être endommagés par des surtensions soudaines.
19. Niveau de pression acoustique au poste de l'opérateur selon la norme CEI 704-1: 1982 n'est pas supérieur à 70 dB (A).

20. L'équipement ne doit être installé que dans une zone d'accès restreint.
21. AVERTISSEMENT: Cet ensemble d'instructions est donné conformément à la norme CEI 704-1. Advantech décline toute responsabilité quant à l'exactitude des déclarations contenues dans ce.

Packing List

Before installation, check that the following items were included with the product:

- 1 x AIR-150 unit
- 2 x Wallmount
- 1 x User manual (Simplified Chinese)
- 1 x WISE-DeviceOn Package
- 1x Phoenix connector counterpart
- 1x Canbus counterpart

Ordering Information

Model Number	Description
AIR-150-S44A1	Intel Core i5-1345UE
AIR-150-S24A1	Intel Core i3-1315UE

Optional Accessories

Part Number	Description
96PSA-A90W19OT-3	Power adapter (DC 19V, 90W)
1700001524	Power Cable 3-pin 180cm, USA type 1
170203183C	Power Cable 3-pin 180cm, Europe type 1
170203180A	Power Cable 3-pin 180cm, UK type
1700008921	Power Cable 3-pin PSE Mark 183cm
1960018849T000	Clip for Din-rail
1960109258N001	DIN rail Bracket

*1960018849T000/1960109258N001 for Din-rail binding suite

Please place the order together for this two PN.

Contents

Chapter 1 General Introduction1

1.1	Introduction	2
1.2	Product Features.....	2
1.2.1	General	2
1.2.2	Display	3
1.2.3	Ethernet	3
1.3	Chipset.....	3
1.3.1	Functional Specifications	3
	Table 1.1: Processor	3
	Table 1.2: Chipset	3
	Table 1.3: Others.....	4
1.4	Mechanical Specifications.....	4
1.4.1	System Dimensions	4
	Figure 1.1 AIR-150 Mechanical Dimensions	4
1.4.2	Weight.....	4
1.5	Power Requirements.....	5
1.5.1	System Power.....	5
1.5.2	RTC Battery	5
1.6	Environmental Specifications	5
1.6.1	Operating Temperature.....	5
1.6.2	Relative Humidity	5
1.6.3	Storage Temperature.....	5
1.6.4	Vibration Tolerance.....	5
1.6.5	Shock Tolerance.....	5
1.6.6	Safety Certification.....	5
1.6.7	EMC Certification	5

Chapter 2 Hardware Installation7

2.1	Introduction	8
2.2	Jumpers	8
2.2.1	Jumper Description	8
2.2.2	Jumper List	8
	Table 2.1: Jumper List.....	8
2.2.3	Jumper Location	9
	Figure 2.1 Jumper Location	9
2.2.4	Jumper Settings.....	9
	Table 2.2: JCMOS1 Clear CMOS.....	9
	Table 2.3: CN22 Auto Power On Setting.....	9
	Table 2.4: SW_422 COM Port Failsafe Setting	10
	Table 2.5: Table 2.5: ERP1 ERP Power-saving Mode	10
2.3	System I/O	10
	Figure 2.2 Front View	10
	Figure 2.3 Rear View	11
2.4	External I/O	11
2.4.1	Power On/Off Button.....	11
	Figure 2.4 Power On/Off Button	11
2.4.2	Power Input Connector	11
	Figure 2.5 Phoenix Terminal Connector	11
2.4.3	Ethernet Connector (LAN1/2)	12
	Figure 2.6 Ethernet Connector	12
	Table 2.6: Ethernet Connector Pin Assignments.....	12
2.4.4	USB 3.2 Gen1 Connector	13
	Figure 2.7 USB 3.2 Connector.....	13

	Table 2.7: USB Connector Pin Definition	13
2.4.5	USB 2.0 Connector.....	13
	Figure 2.8 USB 2.0 Connector	13
	Table 2.8: USB 2.0 Pin Definition.....	13
2.4.6	Audio Connector.....	14
	Figure 2.9 Audio Connector.....	14
2.4.7	COM Connector.....	14
	Figure 2.10COM Connector	14
	Table 2.9: COM Connector Pin Definition	14
2.4.8	HDMI Connector.....	15
	Figure 2.11HDMI Connector.....	15
	Table 2.10: HDMI Connector Pin Definition	15
2.4.9	Antenna Socket	15
	Figure 2.12Antenna Socket.....	15
2.4.10	CANBUS Port and Pin Definition.....	16
	Figure 2.13CANBUS Port.....	16
	Table 2.11: CANBUS Port and Pin Definition.....	16
2.4.11	DIO Connector.....	16
	Figure 2.14DIO Connector	16
	Table 2.12: DIO Connector and Pin Definition	16
2.5	Installation.....	17
2.5.1	M.2 B key/M-key/E-key Installation.....	17
2.5.2	Memory Installation.....	18
2.5.3	Slim SATA Installation	22
2.5.4	AIR-150 Wall Mount Installation	24
2.5.5	AIR-150 DIN-Rail Installation.....	25

Chapter 3 BIOS Settings 27

3.1	Introduction	28
	Figure 3.1	28
3.2	Entering BIOS Setup.....	29
3.2.1	Main Setup.....	29
	Figure 3.2	29
3.2.2	Advanced BIOS Setup.....	30
	Figure 3.3	30
	Figure 3.4	31
	Figure 3.5	31
	Figure 3.6	32
	Table 3.1: Displays the E-core Information	32
	Figure 3.7	33
	Table 3.2: Displays the P-core Information	33
	Figure 3.8	34
	Figure 3.9	34
	Figure 3.10.....	36
	Figure 3.11.....	36
	Figure 3.12.....	37
	Figure 3.13.....	37
	Figure 3.14.....	38
	Figure 3.15.....	39
	Figure 3.16.....	40
	Figure 3.17.....	40
	Figure 3.18.....	42
	Figure 3.19.....	42
	Figure 3.20.....	43
	Figure 3.21.....	44
	Figure 3.22.....	44
	Figure 3.23.....	45
	Figure 3.24.....	45

	Figure 3.25.....	46
	Figure 3.26.....	46
	Figure 3.27.....	47
	Figure 3.28.....	48
	Figure 3.29.....	48
	Figure 3.30.....	49
	Figure 3.31.....	50
	Figure 3.32.....	50
	Figure 3.33.....	51
	Figure 3.34.....	51
3.2.3	Chipset Configuration	52
	Figure 3.35.....	52
	Figure 3.36.....	53
	Figure 3.37.....	53
	Figure 3.38.....	54
	Figure 3.39.....	55
	Figure 3.40.....	55
	Figure 3.41.....	56
	Figure 3.42.....	56
	Figure 3.43.....	57
	Figure 3.44.....	58
	Figure 3.45.....	59
	Figure 3.46.....	59
	Figure 3.47.....	60
	Figure 3.48.....	60
3.2.4	Security	61
	Figure 3.49.....	61
	Figure 3.50.....	62
3.2.5	Boot.....	63
	Figure 3.51.....	63
3.2.6	Save & Exit	64
	Figure 3.52.....	64
3.2.7	NVMe RPMB KEY Migration.....	65
	Figure 3.53.....	65
3.2.8	MEBX.....	65
	Figure 3.54.....	65

Chapter 1

General Introduction

This chapter gives background information on the AIR-150 series.

1.1 Introduction

AIR-150 fanless edge intelligence system is based on Intel 13th generation Core i5/i3 processor, built-in Iris Xe/UHD graphics chipsets, and added-on Hailo AI acceleration module, delivering 26 TOPS AI computing performance. Valued up with rich AI software toolkits to realize AI inferencing, AIR-150 also supports Advantech Edge AI SDK, which is suitable for AI-enabled applications in smart access control & security, parking lot management, and smart factories.

Intel 13th Gen. High Performance Processors

AIR-150 is empowered by Intel 13th generation Core i5/i3 processor, built-in Intel Iris Xe/UHD integrated GPU and vector neural network instruction set (VNNI), which can provide powerful graphics computing performance.

Edge AI Inference by Hailo-8 AI Acceleration Module

AIR-150 is bundled with Hailo-8 AI acceleration module, which delivered 26 TOPS AI capabilities, and supported a variety of software toolkits, to accelerate AI deployment in edge AI, AIR-150 offers easy-to-use toolkit, Advantech edge AI SDK which provides benchmark tool, runtime SDK, remote monitoring and management. Moreover, Hailo TAPPAS and dataflow compiler convert AI and pre-train AI models easily deployment.

Dual HDMI Display & Compact-size with Multiple I/Os

AIR-150 features small and fanless design, which also supports -20~60°C operating temperature, and qualified for IEC standard 61000-6-2 / 61000-6-4 Heavy Industry certification. The system dimensions is 156 x 112 x 60 mm compact size but with multiple I/Os, including 2x CANBus, 1x 2.5GbE, 1x 1GbE, 1x DIO, 2x RS-232/422/485, 1x RS-485 (COM3), 3x USB 3.2, 1x USB 2.0 and support M.2 M-key 2280 / E-Key 2230/ B key 3042 (Default bundled with Hailo AI module) expansions.

1.2 Product Features

1.2.1 General

- **CPU:**
 - Intel Core i5-1345UE
 - Intel Core i3-1315UE
- **BIOS:** AMI 256 Mbit Flash BIOS
- **System Memory:**
 - Dual Channel DDR5 5200 MHz 260 pin SO-DIMM
 - Max. capacity 64GB
- **Serial Port:** 2 x RS-232/422/485, 1 x RS-485 (COM3)
- **USB:** 3 x USB 3.2 Gen1, 1 x USB 2.0
- **Audio:** High-definition (HD) audio, Mic-in/Line-out
- **Storage:** 1x Slim SATA/1x M.2 M-key 2280 (SATA, PCIe4 NVMe)
- **Expansion Interface:**
 - 1 x M.2 2280 M key
 - 1 x M.2 2230 E key
 - 1 x M.2 3042 B key (Default bundled with Hailo AI module)
 - 2 x CANBUS
 - 1 x 8 pin DIO

- 2x LAN (1x 1GbE/1x 2.5 GbE)

1.2.2 Display

- **Controller:**
 - Controller for Core i5: Intel® Iris® Xe chipset
 - Controller for Core i3: Intel® UHD chipset
- **Resolution:** Supports up to 4096x2160@60Hz
- **Dual Display:** 2x HDMI 2.0b

1.2.3 Ethernet

- **Chipset:**
 - LAN1 Intel® I219-LM 1x 1GbE
 - LAN2 Intel® I226-LM 1x 2.5 GbE
- **LAN1 Speed:** 10/100/1000 Mbps
- **LAN2 Speed:** 10/100/1000/2500 Mbps
- **Interface:** 2 x RJ45
- **Standard:** Compliant with IEEE 802.3, IEEE 802.3u, IEEE 802.3x, IEEE 802.3y, IEEE 802.ab.

1.3 Chipset

1.3.1 Functional Specifications

1.3.1.1 Processor

Table 1.1: Processor	
Processor	Intel Core i5-1345UE Intel Core i3-1315UE
Memory	Dual Channel DDR5 5200 MHz 260 pin SO-DIMM Max. capacity 64GB

1.3.1.2 Chipset

Table 1.2: Chipset	
Internal Graphics Features	Direct X 12.1, OpenGL 4.6 2 x HDMI 2.0b
Video Accelerator	H/W accelerated video encoding/decoding Video decoder: Support H.265/HEVC, H.264/AVC, VP9, SCC Video encoder: Support H.265/HEVC, H.264/AVC, VP9, SCC
SATA Interface	Supports several optional sections of Serial SATA III: Extensions to Serial ATA 1.0 specification, Revision 1.0 Supports SATA transfers to 300 Mbytes/sec.
USB Interface	USB host interface with support for 3 x USB 3.2 and 1 x USB 2.0 port All ports are High-Speed, Full-Speed, and Low-Speed capable
BIOS	AMI 256 Mbit Flash BIOS

1.3.1.3 Others

Table 1.3: Others

Serial Ports	2 x RS-232/422/485, 1 x RS-485 (COM3), supports auto-flow control
DIO	1 x 8 bit DIO
CANBus	2 x CANBus (2 ports)
USB	3 x USB 3.2, 1 x USB 2.0
Ethernet	<p>LAN1 Intel I219-LM, LAN2 Intel I226-LM</p> <ul style="list-style-type: none"> Compliant with IEEE 802.3, IEEE 802.3u, IEEE 802.3x, IEEE 802.3y, and IEEE 802.ab LAN1 Supports 10/100/1000 Mbps. LAN2 Supports 10/100/1000/2500 Mbps. <p>LAN Connectors: Phone Jack RJ45 8P 90D(F)</p>
Audio	<p>Audio Codec: Realtek ALC888S:</p> <ul style="list-style-type: none"> Compliant with HD audio specifications Supports 16/20/24-bit DAC and 16/20/24-bit ADC resolution Supports Line Out and Mic In audio <p>Connectors: 1 x Earphone jack</p>
Battery	1 x 3V/220 mAh battery with wire

1.4 Mechanical Specifications

1.4.1 System Dimensions

156 x 112 x 60 mm

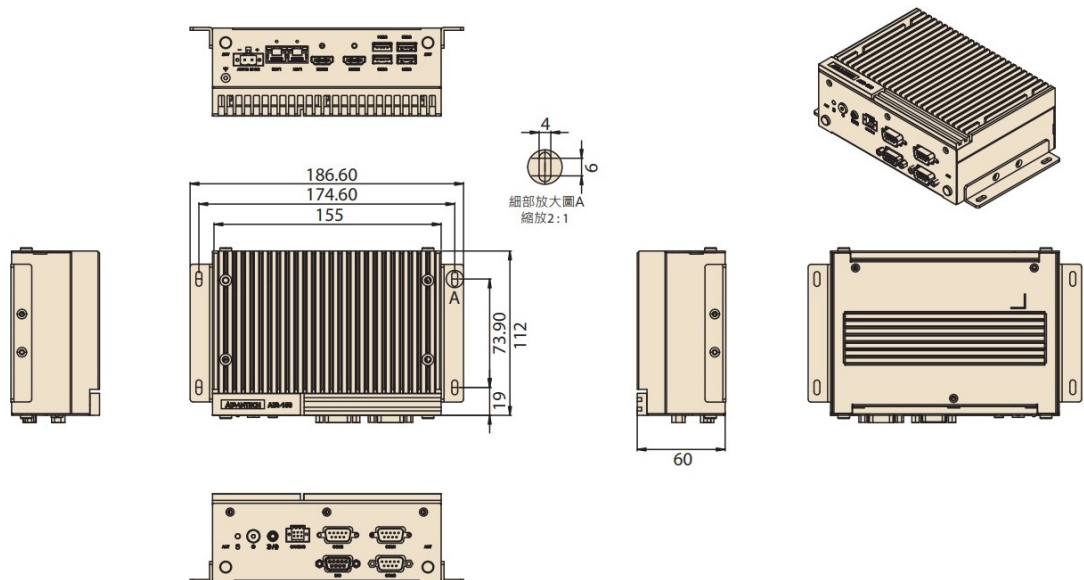

Figure 1.1 AIR-150 Mechanical Dimensions

1.4.2 Weight

1.3 Kg

1.5 Power Requirements

1.5.1 System Power

- Power Input: DC In 12V-24V

1.5.2 RTC Battery

- Lithium: 3V/220mAH

1.6 Environmental Specifications

1.6.1 Operating Temperature

- -20 ~ 60 °C, with 0.7m/s air flow

1.6.2 Relative Humidity

- 95% @ 40 °C (104 °F) (non-condensing)

1.6.3 Storage Temperature

- -40 ~ 85 °C (-40 ~ 185 °F)

1.6.4 Vibration Tolerance

- When the system is equipped with an Slim SATA: 3 Grms, IEC 60068-2-64, random, 5 ~ 500 Hz, 1 hr/axis, (x, y, z) 3 axes

1.6.5 Shock Tolerance

- When the system is equipped with an Slim SATA: 30 G, IEC 60068-2-27, half sine, 11 ms duration

1.6.6 Safety Certification

- UL, CB, CCC, BSMI

1.6.7 EMC Certification

- CE/FCC Class B, Heavy Industry 61000-6-4, 61000-6-2, CCC, BSMI

Chapter 2

Hardware Installation

This chapter details instructions for installing AIR-150 hardware and external I/O.

2.1 Introduction

The following sections demonstrate the internal jumper settings and the external connector pin assignments.

2.2 Jumpers

2.2.1 Jumper Description

AIR-150 can be configured to satisfy specific application requirements by setting jumpers. A jumper is a metal bridge used to close an electric circuit. It consists of two metal pins and a small metal clip (often protected by a plastic cover) that slides over the pins to connect them. To close a jumper, connect the pins with the clip. To open a jumper, remove the clip. Sometimes a jumper will have three pins, labeled 1, 2, and 3. For these jumpers, connect either pins 1 and 2, or 2 and 3.

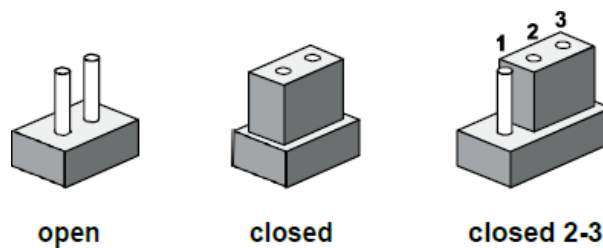

The jumper settings are schematically diagrammed in this manual as follows:

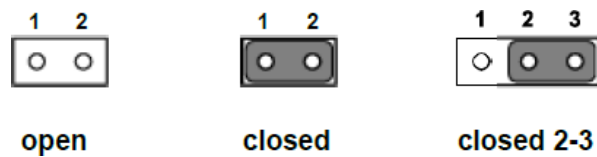

A pair of needle-nose pliers may be necessary when working with jumpers. Users with concerns regarding the ideal hardware configuration for your application should contact your local distributor or sales representative before making any changes. Usually, only a standard cable is required to make most connections.

2.2.2 Jumper List

Table 2.1: Jumper List

Location	Function
JCMOS1	Clear CMOS
CN22	Auto Power On Setting
SW_422_1	RS485/RS422 Fail Safe Enabled/Disabled
SW_422_2	RS485/RS422 Fail Safe Enabled/Disabled
ERP1	For ERP Power-saving Mode

2.2.3 Jumper Location

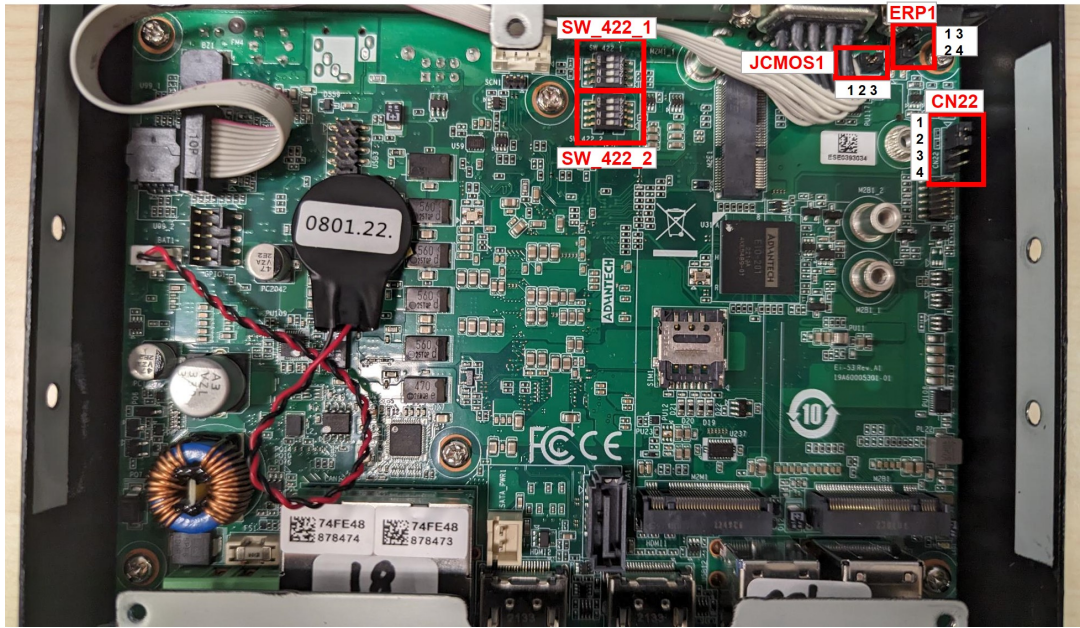

Figure 2.1 Jumper Location

2.2.4 Jumper Settings

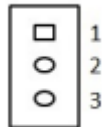

Table 2.2: JCMOS1 Clear CMOS	
Part Number	1653003101
Description	PIN HEADER 3x1P 2.0mm 180D(M) DIP 2000-13 WS
Default Setting	(1-2)
Jumper Setting	(2-3): Clear CMOS

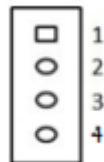

Table 2.3: CN22 Auto Power On Setting	
Part Number	1653004101
Description	PIN HEADER 4x1P 2.0mm 180D(M) DIP 21N12050
Default Setting	(1-2): ATX mode
Jumper Setting	(3-4): AT mode

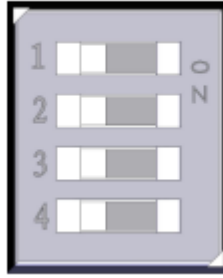

Table 2.4: SW_422 COM Port Failsafe Setting

SW_422_1 (COM1_SAFE1)	Mode/Description	Pin1	Pin2	Pin3	Pin4
SW_422_2 (COM2_SAFE2)	Default	OFF	OFF	OFF	OFF
	RS422_TX/RX external pull up/down	ON	ON	ON	ON
	RS-485 TX external pull up/down	ON	ON	OFF	OFF

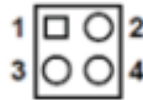

Table 2.5: Table 2.5: ERP1 ERP Power-saving Mode

Part Number	1653000014
Description	PIN HEADER 2x2P 2.00mm 180D(M) SMD 21N22050
Default Setting	(1-2 short): Normal mode
Jumper Setting	(3-4 short): Enable ERP Power-saving mode

2.3 System I/O

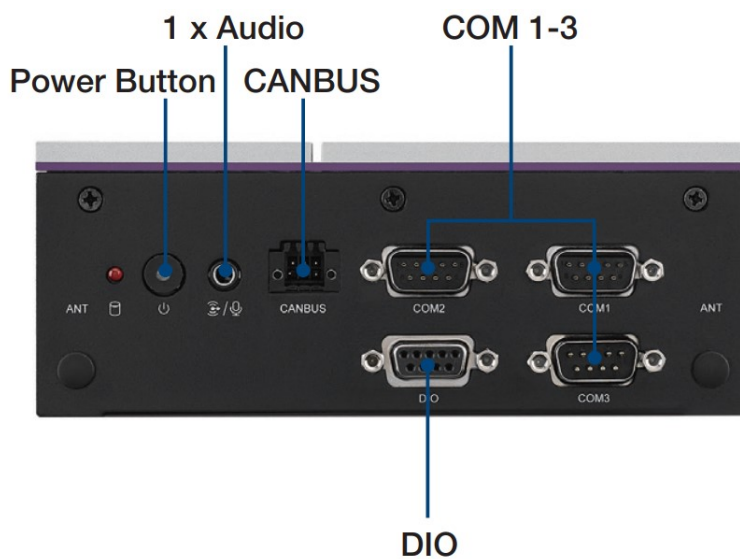

Figure 2.2 Front View

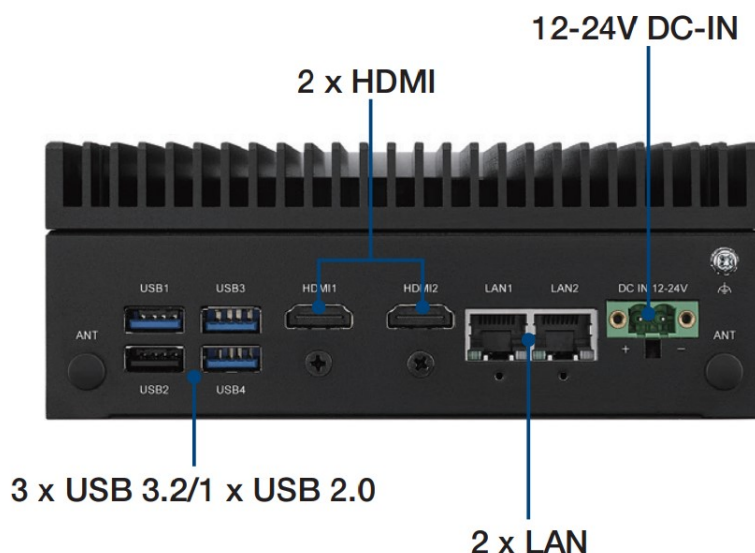

Figure 2.3 Rear View

2.4 External I/O

2.4.1 Power On/Off Button

AIR-150 features a Power On/Off button with an LED indicators on the top side that show On status (Green LED).



Figure 2.4 Power On/Off Button

2.4.2 Power Input Connector

AIR-150 supports one 2-pin Phoenix terminal power input connector. Connect the positive and negative power cables to the terminals in the power distribution connector correctly at the same time.

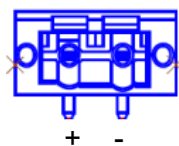

Figure 2.5 Phoenix Terminal Connector

- Note!**
1. For supply connections use wires suitable for at least 75°C.
 2. The terminal block is suitable for 14 AWG. Torque value 7lb-in User copper conductors only. Must be installed by skilled person.
 3. The terminal block uses two sets of interfaces to make it split to meet the maximum current limit, and a single pin will be limited below 16A.

2.4.3 Ethernet Connector (LAN1/2)

AIR-150 is equipped with one Intel® I219-LM and one Intel® I226-LM Ethernet controllers that are fully compliant with IEEE 802.3u and 802.3bz 10/100/1000/2500 Mbps CSMA/CD standards and connected to LAN1 and LAN2. The Ethernet port provides a standard RJ45 jack connector with LED indicators on the front side to show its Active/Link status (Green LED) and Speed status (Orange/Yellow LED).

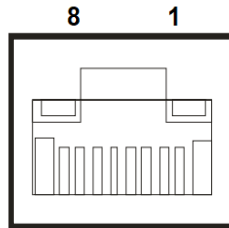

Figure 2.6 Ethernet Connector

Table 2.6: Ethernet Connector Pin Assignments

Pin	10/100/1000BaseT Signal Name
1	TX+
2	TX-
3	RX+
4	MDI2+
5	MDI2-
6	RX-
7	MDI3+
8	MDI3-

2.4.4 USB 3.2 Gen1 Connector

AIR-150 supports three USB 3.2 interfaces, which support Plug-and-Play functionality and hot swapping for up to 127 external devices. The USB interfaces comply with USB UHCI, Rev. 3.2.

USB 3.2 connectors contain legacy pins to interface to USB 2.0 devices and a new set of pins for USB 3.2 connectivity.

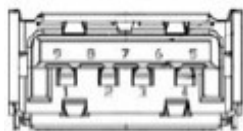

Figure 2.7 USB 3.2 Connector

Table 2.7: USB Connector Pin Definition

Pin	Signal Name
1	+5V
2	D-_0
3	D+_0
4	GND
5	USB0_SSRX-
6	USB0_SSRX+
7	GND
8	USB0_SSTX-
9	USB0_SSTX+

2.4.5 USB 2.0 Connector

AIR-150 supports one USB 2.0 interfaces, which support Plug-and-Play functionality.

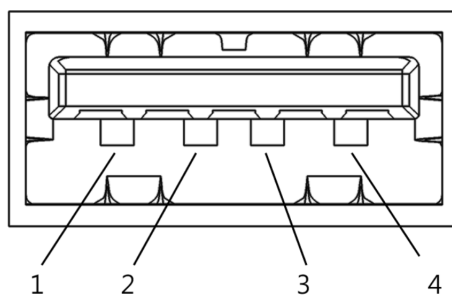

Figure 2.8 USB 2.0 Connector

Table 2.8: USB 2.0 Pin Definition

Pin	Signal Name
1	VCC
2	USB_data
3	USB_data+
4	GND

2.4.6 Audio Connector

AIR-150 features one phone jack connectors that support stereo Line Out and Mic In audio ports. The audio chip is controlled by ALC888S and compliant with the Azalea standard.

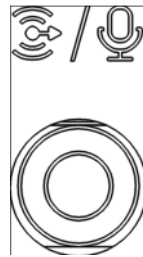

Figure 2.9 Audio Connector

2.4.7 COM Connector

AIR-150 provides two 9-pin COM connector, which supports RS232/422/485 serial communication interface ports. The default setting is RS-232, if you want to use RS-422/485, you can use the BIOS manual to change settings. Furthermore, the third one is only for RJ485.

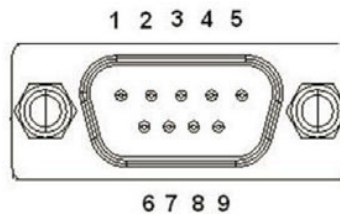

Figure 2.10 COM Connector

Table 2.9: COM Connector Pin Definition

Pin	RS-232	RS-422	RS-485
1	DCD	Tx-	DATA-
2	RxD	Tx+	DATA+
3	TxD	Rx+	NC
4	DTR	Rx-	NC
5	GND	GND	GND
6	DSR	NC	NC
7	RTS	NC	NC
8	CTS	NC	NC
9	RI	NC	NC

NC represents "No Connection".

2.4.8 HDMI Connector

AIR-150 offers two integrated 19-pin receptacle connector HDMI 2.0b interfaces. The HDMI link supports resolutions up to 4096 x 2160 @ 60 Hz.

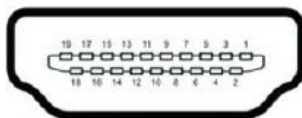

Figure 2.11 HDMI Connector

Table 2.10: HDMI Connector Pin Definition

Pin	Signal Name
1	HDMI_TX2+
2	GND
3	HDMI_TX2-
4	HDMI_TX1+
5	GND
6	HDMI_TX1-
7	HDMI_TX0+
8	GND
9	HDMI_TX0-
10	HDMI_CLK+
11	GND
12	HDMI_CLK-
13	NC
14	NC
15	HDMI_DCLK
16	HDMI_DDAT
17	GND
18	+V5_HDMI-HPD
19	DDP0_HPD

NC represents "No Connection".

2.4.9 Antenna Socket

AIR-150 reserves four antenna sockets for installing wireless/LTE device antennas. Each antenna socket is labeled "ANT" for easy identification.



Figure 2.12 Antenna Socket

2.4.10 CANBUS Port and Pin Definition

AIR-150 offers CANBUS port and pin definition as below.

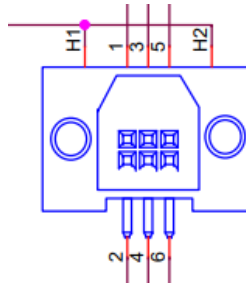

Figure 2.13 CANBUS Port

Table 2.11: CANBUS Port and Pin Definition

Pin	Signal Name
1	CAN0_D-
2	CAN1_D+
3	GND
4	GND
5	CAN0_D+
6	CAN1_D-

2.4.11 DIO Connector

AIR-150 offers 9-bit DI/O and pin definition as below.

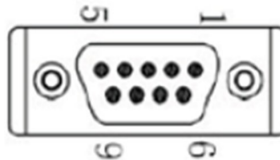

Figure 2.14 DIO Connector

Table 2.12: DIO Connector and Pin Definition

Pin	Signal Name
1	DIO bit 0
2	DIO bit 1
3	DIO bit 2
4	DIO bit 3
5	DIO bit 4
6	DIO bit 5
7	DIO bit 6
8	DIO bit 7
9	GND

2.5 Installation

2.5.1 M.2 B key/M-key/E-key Installation

1. Loosen the 7 screws affixing screws and remove the bottom cover.

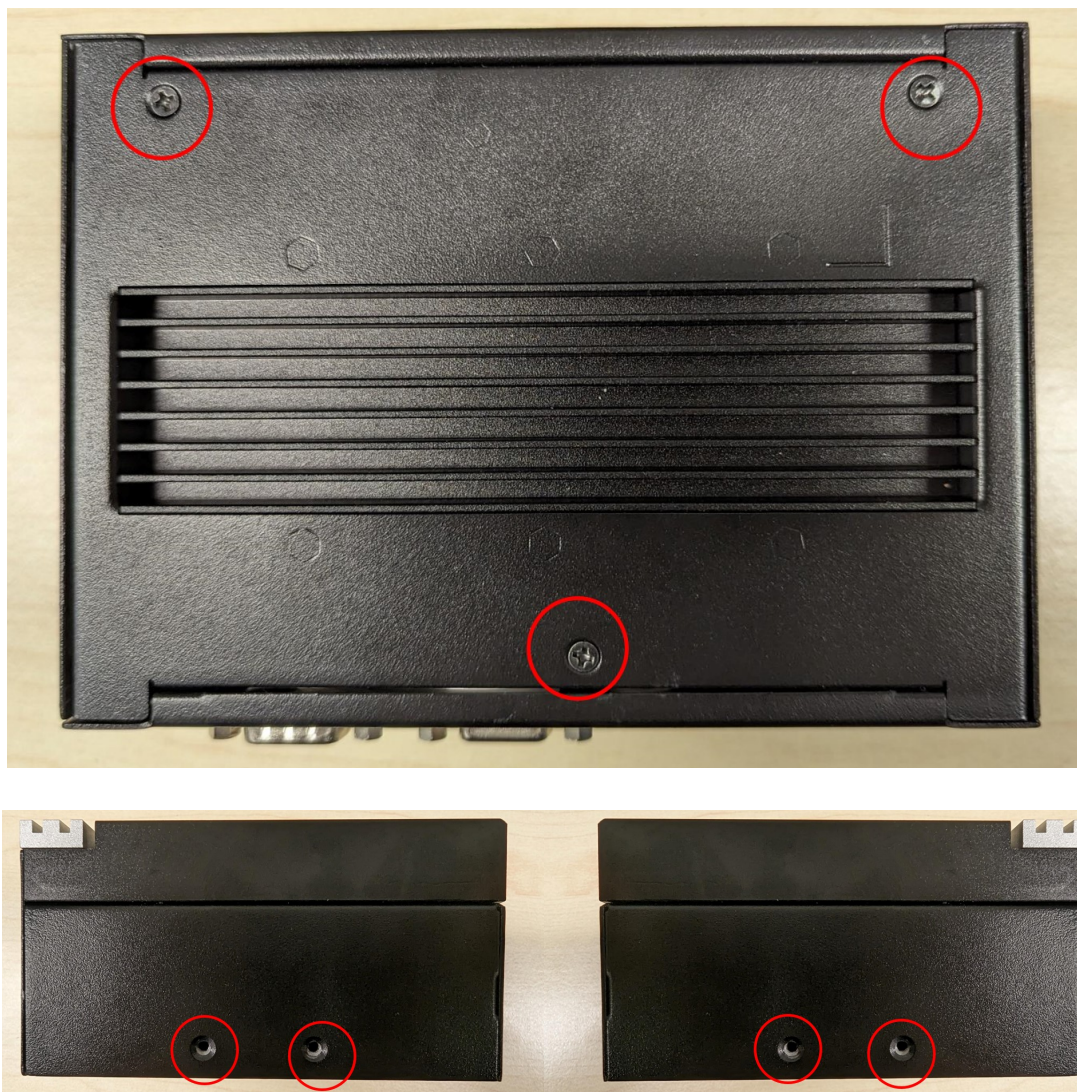

2. Install the M.2 2280 M/ 2230 E key module.
 - Install the M.2 E-Key 2230 (with round head screw).
 - Install the M.2 M-Key 2280 module (with round head screw).

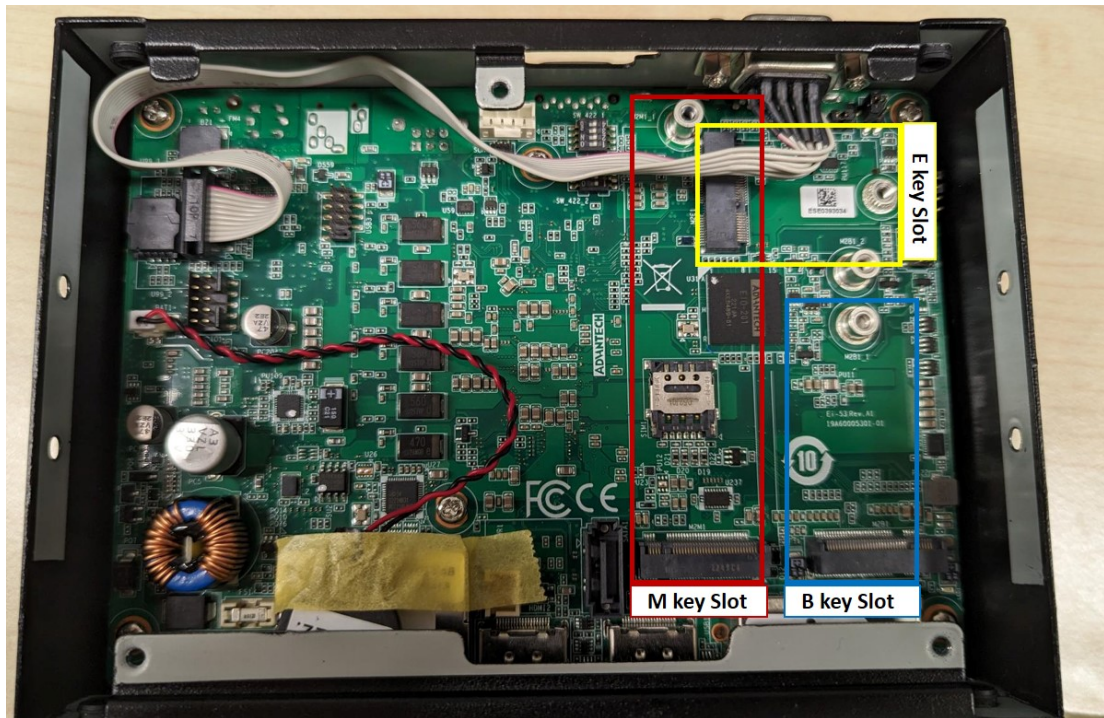

2.5.2 Memory Installation

1. Loosen 4 screws affixing screws and remove the TOP cover.

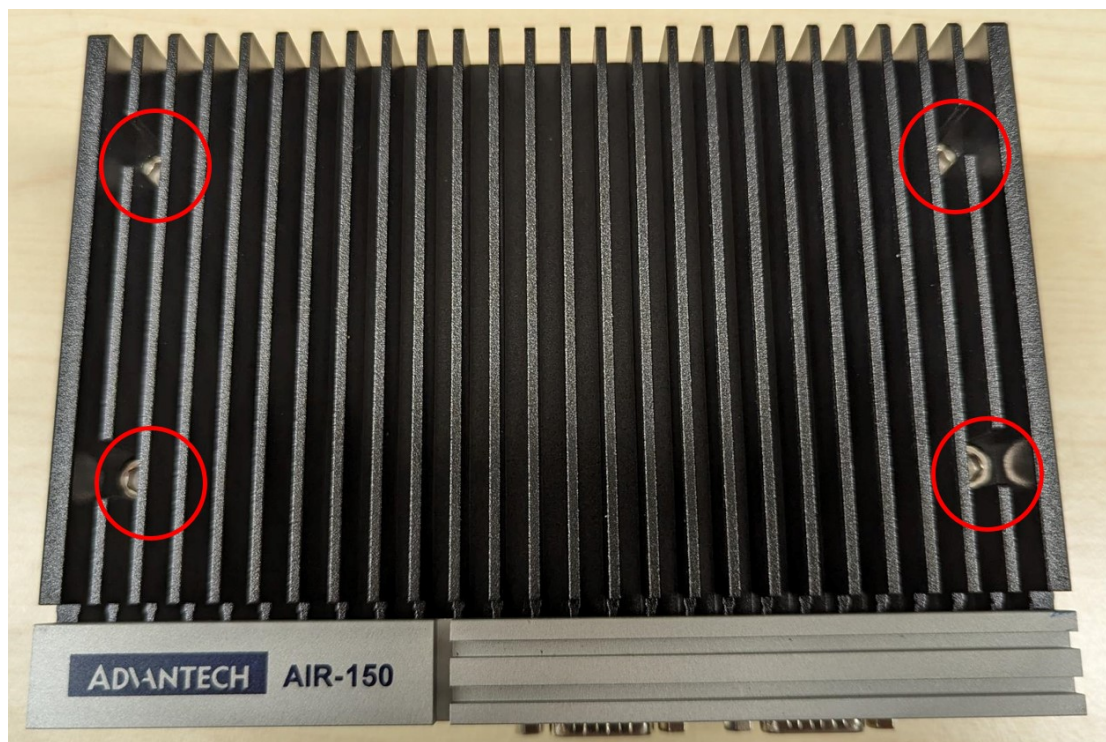

2. Use two thermal pad from accessory box.
 - If only one memory slot is used, the memory must be inserted into the NO.2 socket without using any thermal pad.
- PS: NO.1 socket is not recommended.

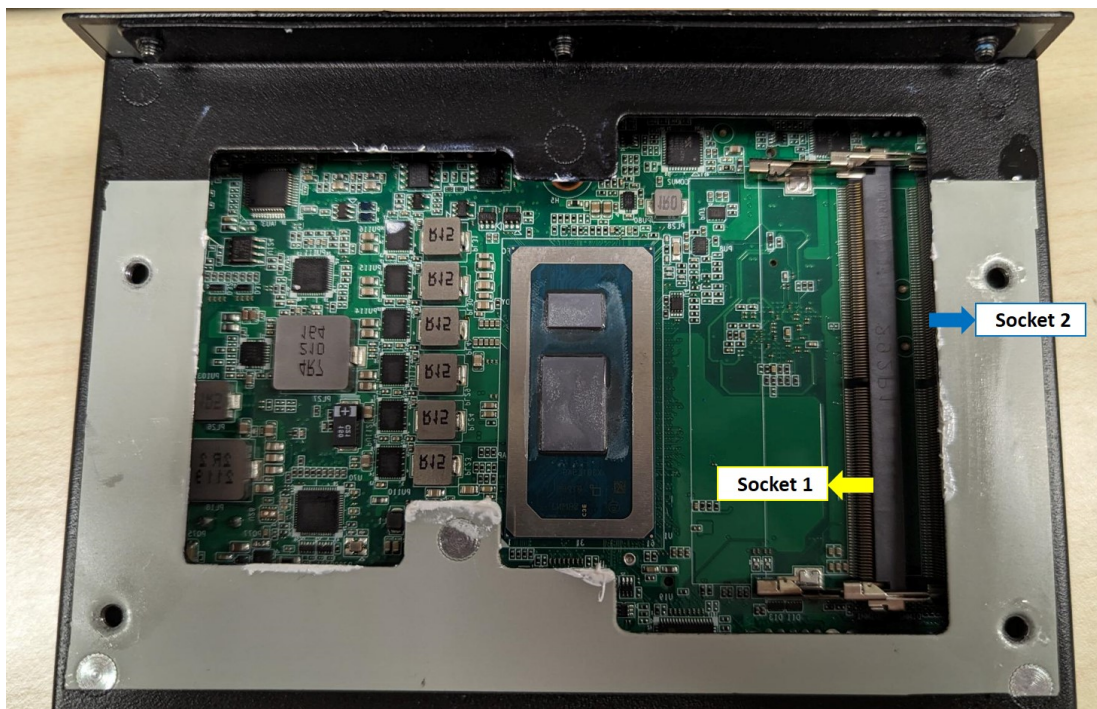

- If two memory (full slots) are used, two types of thermal pads are required (available in the Accessory bag).
 - First, use a larger thermal pad, attach to the back of the first memory (near the MB face), and plug in the NO.1 socket.



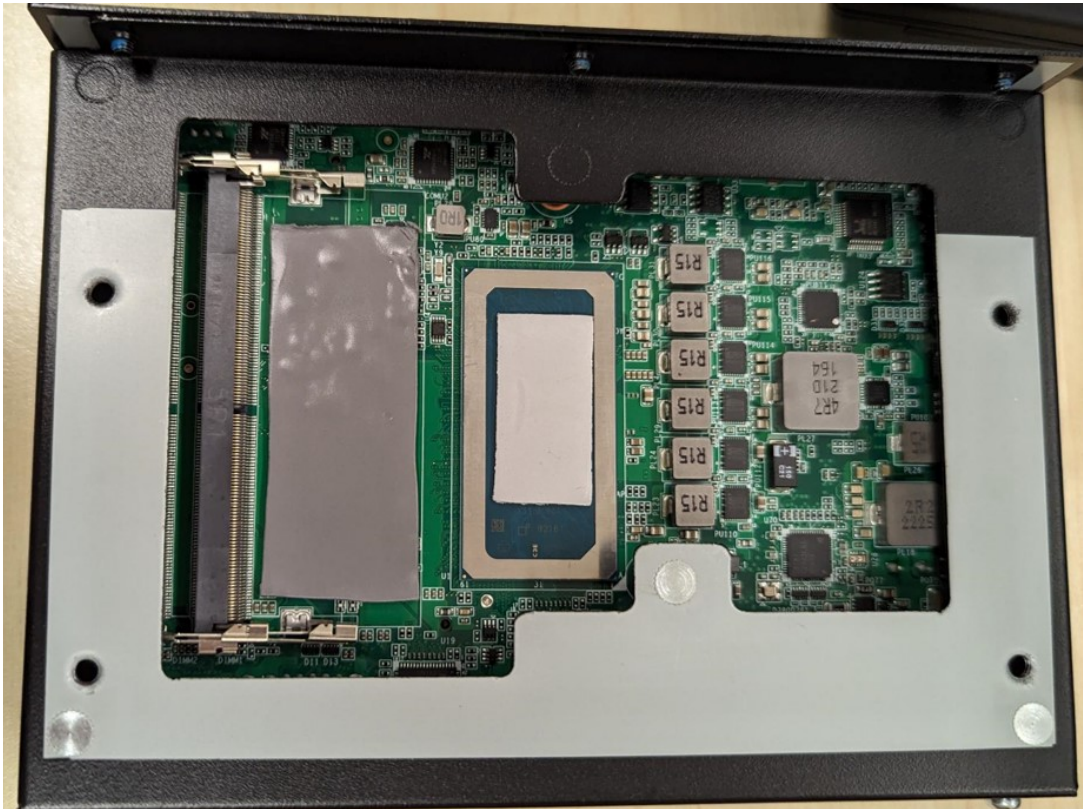

– Finally, use smaller one for rest memory for NO.1 Slot



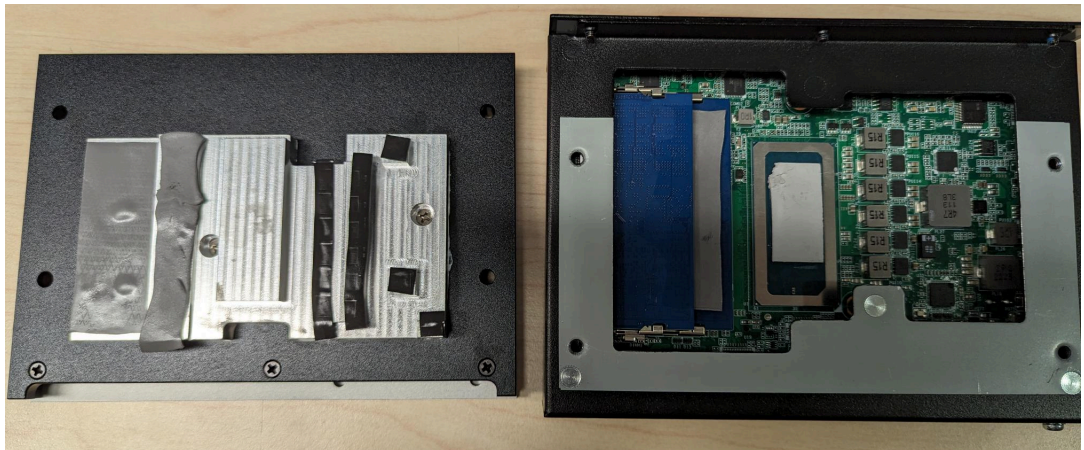

2.5.3 Slim SATA Installation

1. Loosen the 7 screws affixing screws and remove the bottom cover.

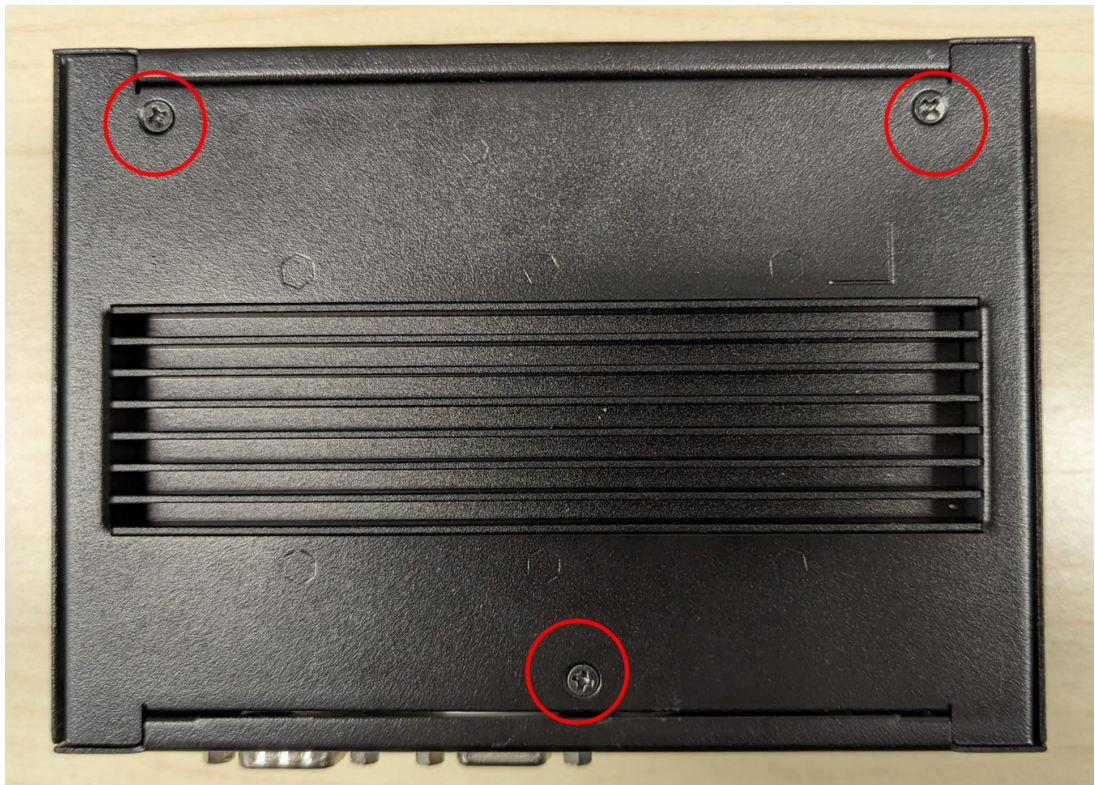

2. Let Slim SATA to Fasten 4 screws onto bottom cover.

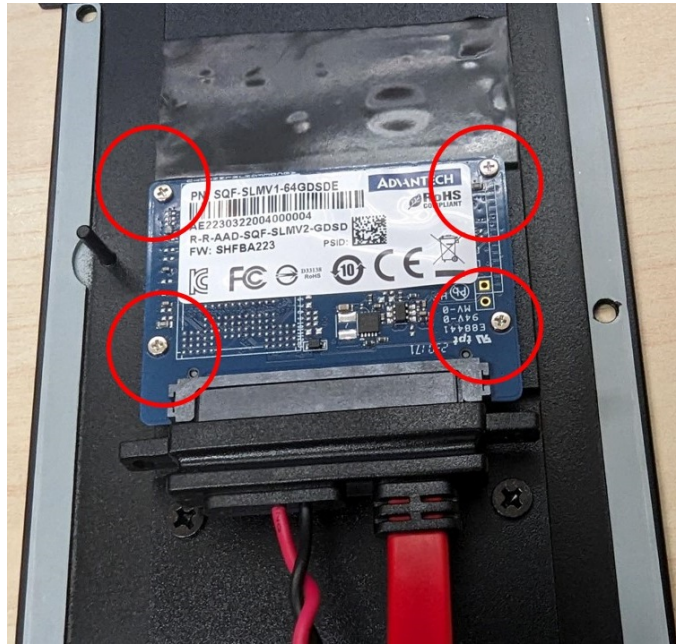

3. Insert SATA Cable into MB.

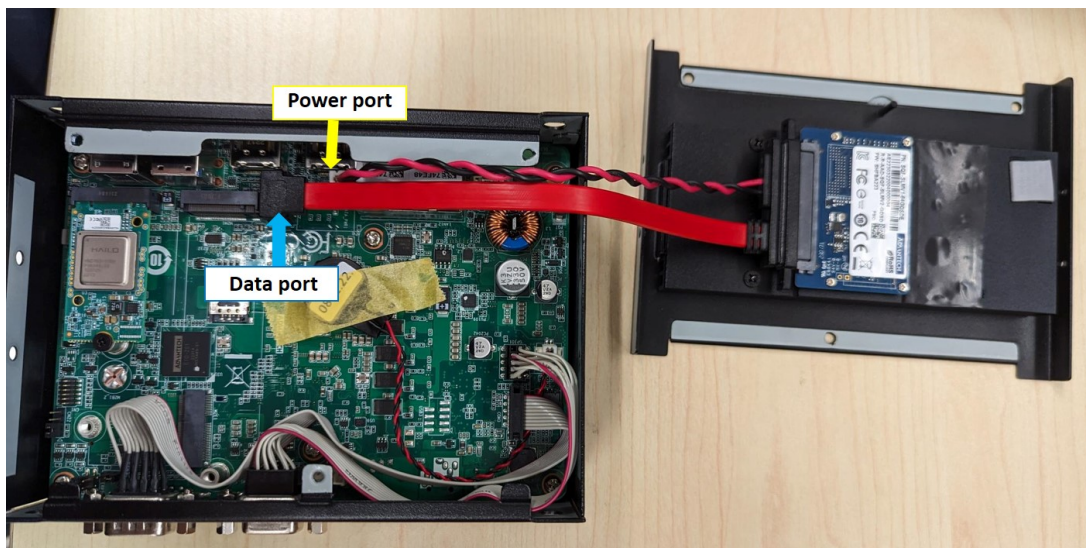

2.5.4 AIR-150 Wall Mount Installation

1. AIR-150 default supports wall mount with the two wings on the bottom cover.
2. Use 4x existed screw (with flat head screw) which already attached on side cover.

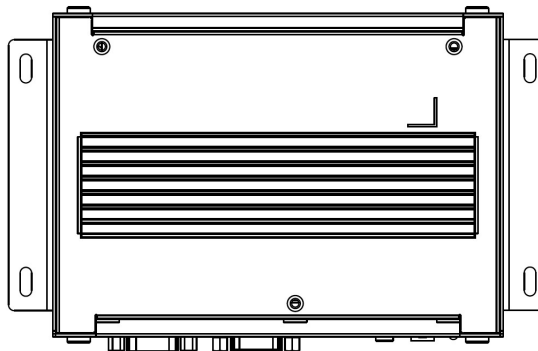
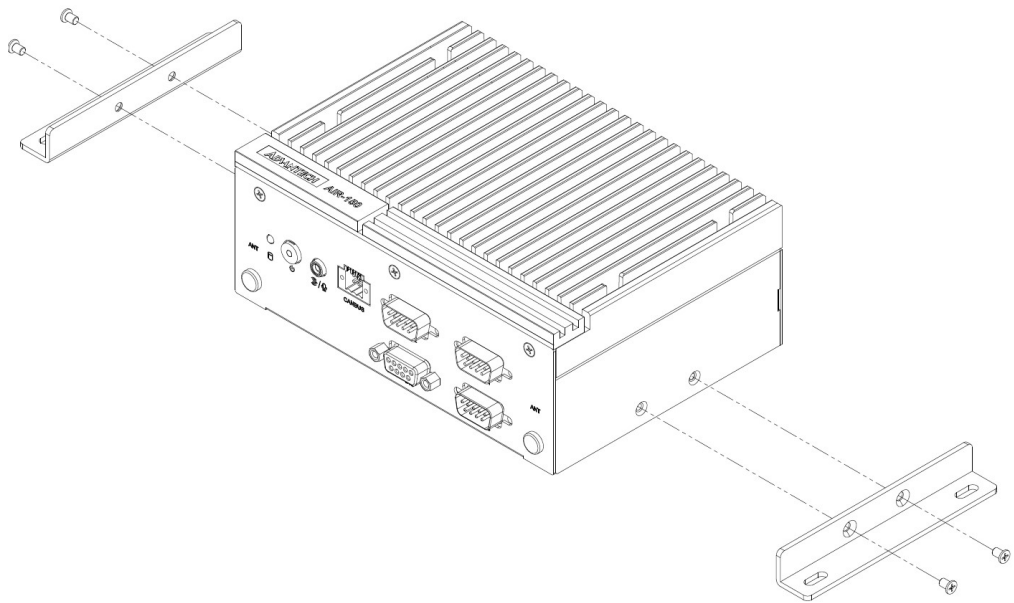
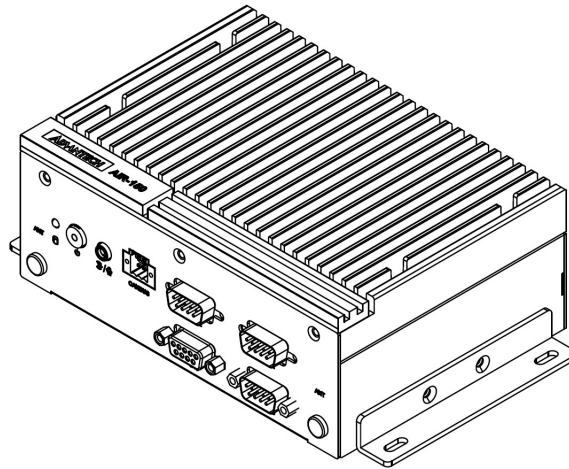

2.5.5 AIR-150 DIN-Rail Installation

1. AIR-150 supports optional DIN-Rail.
2. Use 7x 19300086506 Screw (with flat head screw), which is the same with wall Mount screw. (P.S. 3x screw in the accessory bag.)

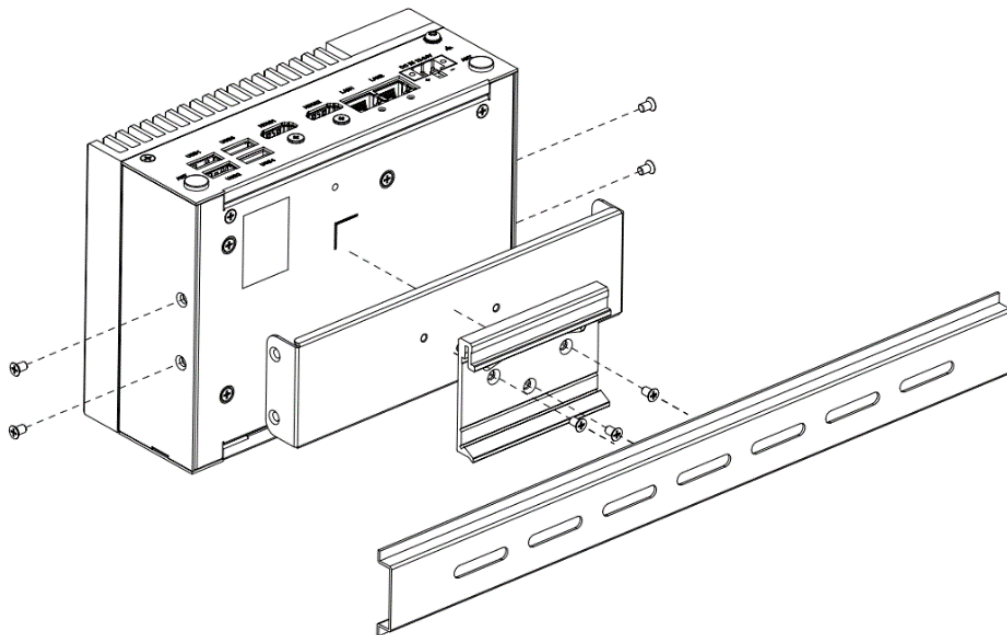

Chapter 3

BIOS Settings

This chapter details the BIOS configuration instructions.

3.1 Introduction

The AMI BIOS ROM has a built-in setup program - the BIOS Setup Utility - that allows users to modify the basic system configuration. All configuration data is stored in battery-backed CMOS to ensure the setup information is retained when the power is turned off.

This chapter describes the basic navigation of the AIR-150 BIOS setup screens.

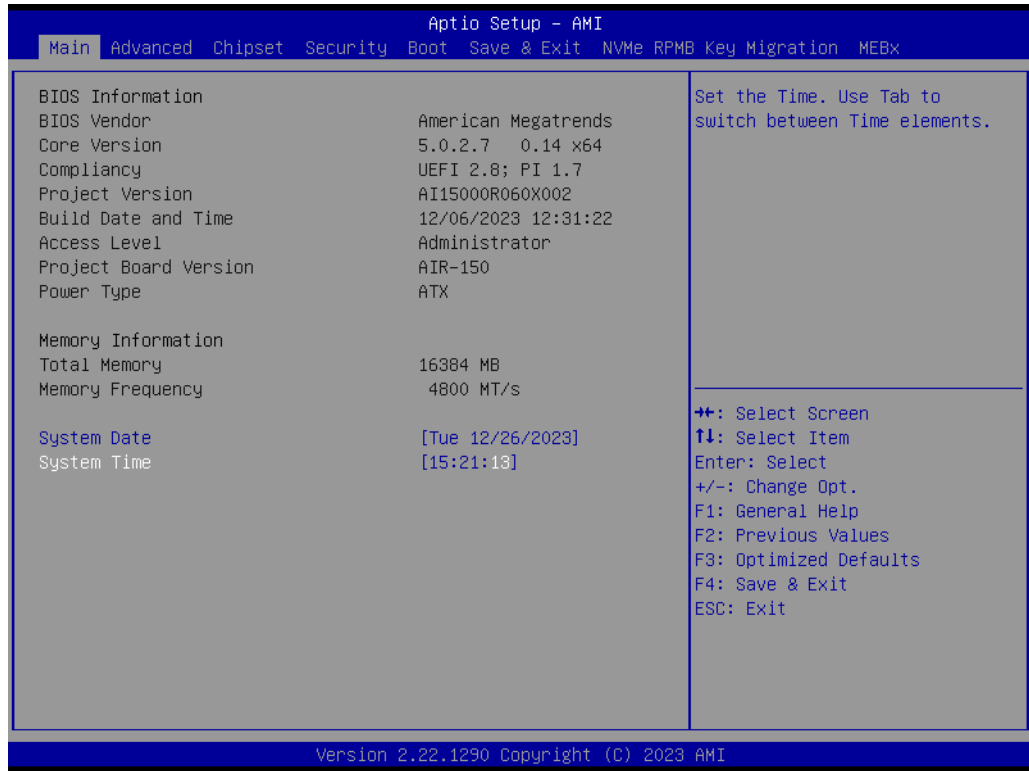

Figure 3.1

3.2 Entering BIOS Setup

Turn on the computer and then press ESC or DEL to enter the BIOS Setup menu.

3.2.1 Main Setup

Upon accessing the BIOS Setup Utility, users are presented with the Main setup page. Users can always return to the Main setup page by selecting the Main tab. The Main BIOS Setup page is shown below.

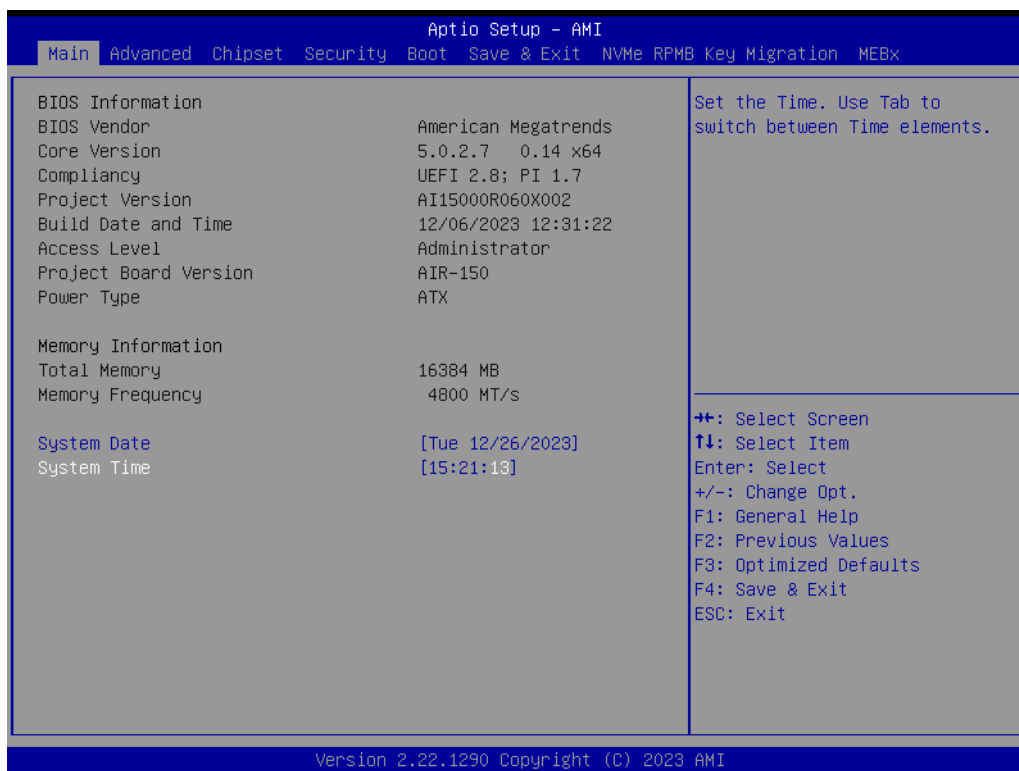

Figure 3.2

The Main BIOS setup page has two main frames. The left frame displays all the items accessible on the Main page. Items that are grayed out cannot be configured, whereas items presented in blue text can be configured. The right frame displays the key legend.

Located above the key legend is an area reserved for a text message. When an item is selected in the left frame, the item is presented in white text and often accompanied by a text message.

■ System Time/System Date

Use this option to change the system time and date. Highlight System Time or System Date using the <Arrow> keys. Enter new values via the keyboard. Press the <Tab> key or the <Arrow> keys to move between fields. The date must be entered in MM/DD/YY format, and the time must be entered in HH:MM:SS format.

3.2.2 Advanced BIOS Setup

Select the Advanced tab from the BIOS Setup Utility to enter the Advanced BIOS Setup page. Select any of the items in the left frame of the screen, such as CPU Configuration, to access the sub menu for that item. The options for any of the Advanced BIOS Setup items can be displayed by highlighting the item using the <Arrow> keys.

3.2.2.1 WWAN Configuration

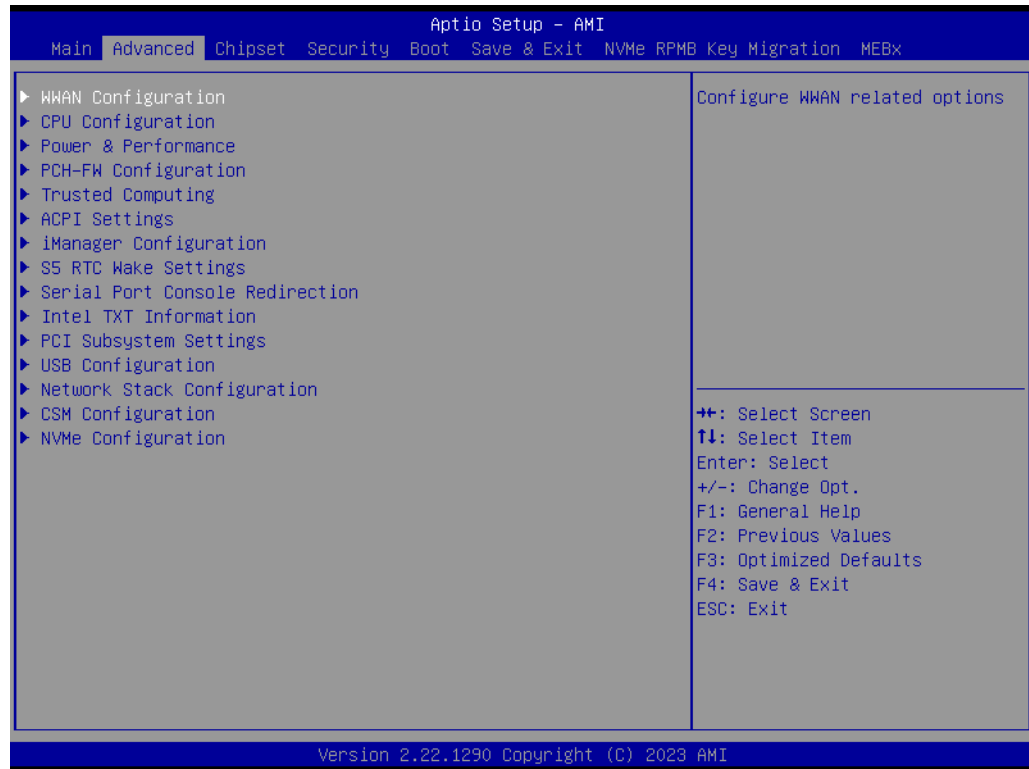

Figure 3.3

■ WWAN DEVICE

When Disabled, Select the M.2 WWAN Device options to enable 4G - 7360/7560 (Intel), 5G - M80 (MediaTek) Modems.

3.2.2.2 CPU Configuration

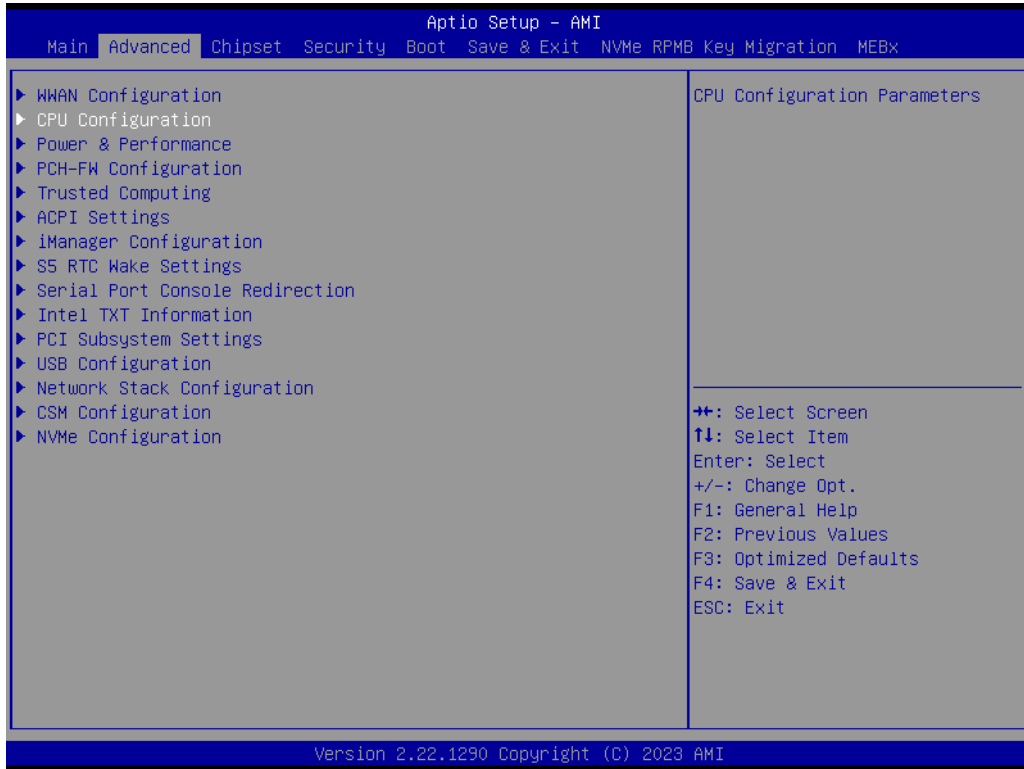

Figure 3.4



Figure 3.5

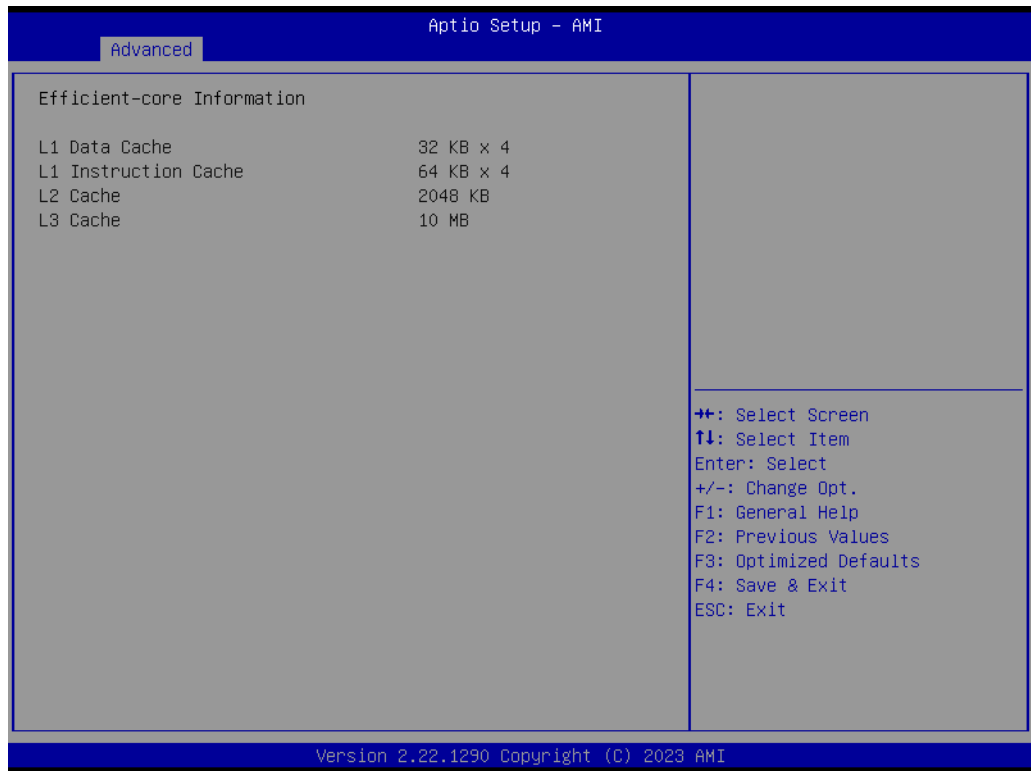

Figure 3.6

■ Efficient-core Information

Table 3.1: Displays the E-core Information

L1 Data Cache	32 KB X 8	Displays the Efficient-core L1 Data Cache size.
L1 Instruction Cache	64 KB	Displays the Efficient-core L1 Instruction Cache size.
L2 Cache	2048 KB X 2	Displays the Efficient-core L2 Cache size.
L3 Cache	12 MB	Displays the Efficient-core L3 Cache size.



Figure 3.7

- Performance-core Information

Table 3.2: Displays the P-core Information

L1 Data Cache	48 KB X 2	Displays the Performance-core L1 Data Cache size.
L1 Instruction Cache	32 KB x 2	Displays the Performance-core L1 Instruction Cache size.
L2 Cache	1280 KB X 2	Displays the Performance-core L2 Cache size.
L3 Cache	12 MB	Displays the Performance-core L3 Cache size.

3.2.2.3 Power & Performance

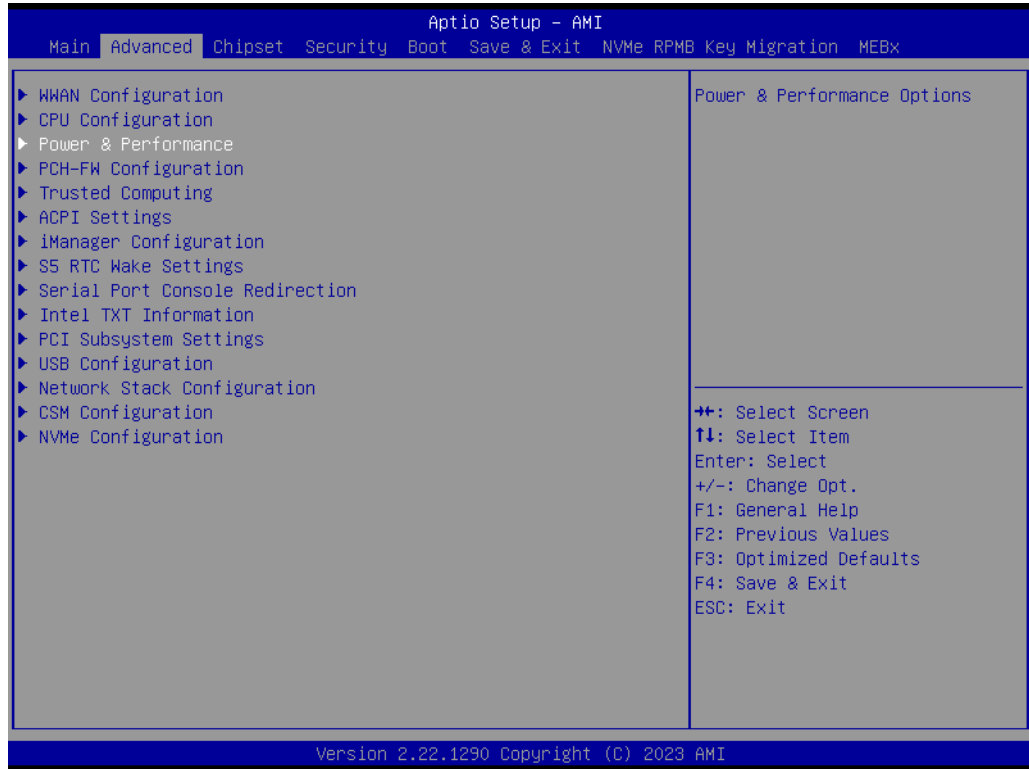

Figure 3.8

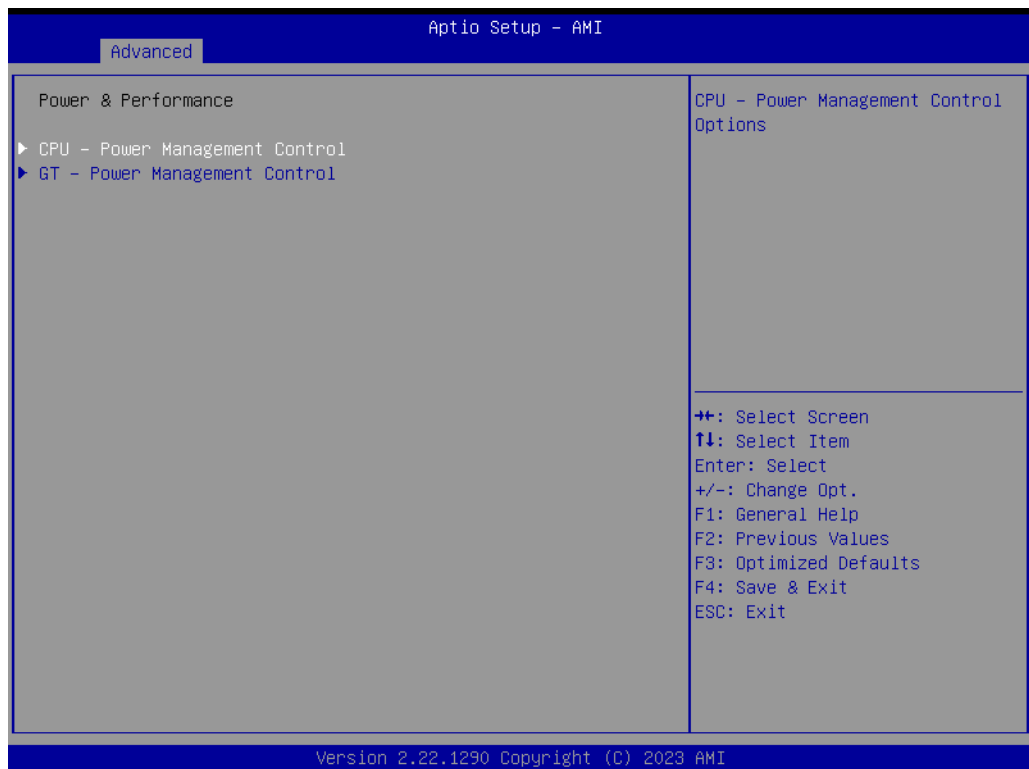

Figure 3.9

CPU - Power Management Control

■ View/Configure Turbo Options

View/Configure Turbo Options.

- Turbo Ratio Limit Options
View/Configure Turbo Ratio Limit Options.
- **CPU VR Setting**
Current Vccln AUX Icc Max.
- **GT VR Settings**
Configure GT VR Settings.
 - GT VR Fast Vmode
GT VR Fast Vmode. Use to control GT Fast Vmode Enable/Disable.
 - VR Voltage Limit
Voltage Limit (VMAX). This value represents the Maximum instantaneous voltage allowed at any given time. Range is 0 - 7999mV. Uses BIOS VR mailbox command 0x8.
- **RFI Settings**
Configure RFI Settings
 - RFI Current Frequency
139.200MHZ
 - RFI Frequency
Set desired RFI frequency, in increments of 100KHz. (For a frequency of 100.6MHz, enter 1006.)
- **Custom P-state Table**
Add Custom P-state Table.

- **GT - Power Management Control**
- **RC6(Render Standby)**
Check to enable render standby support.
- **Maximum GT frequency**
Maximum GT frequency limited by the user.
- **Disable Turbo GT frequency**
Enabled: Disables Turbo GT frequency. Disabled: GT frequency is not limited.

3.2.2.4 PCH-FW Configuration

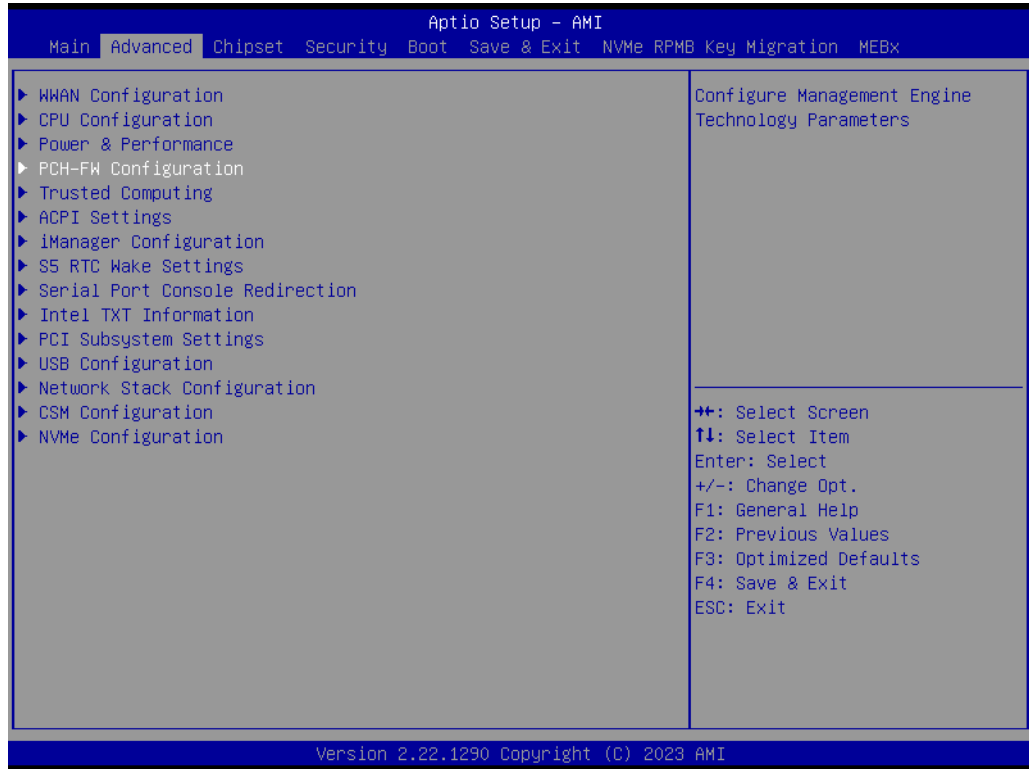

Figure 3.10

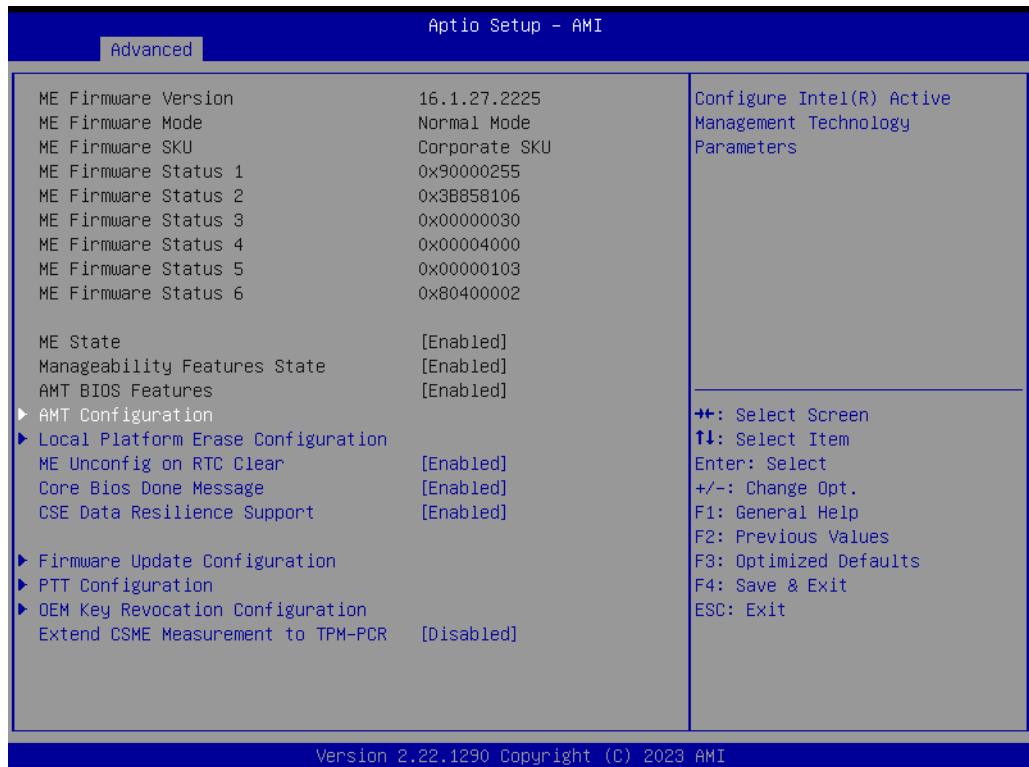

Figure 3.11

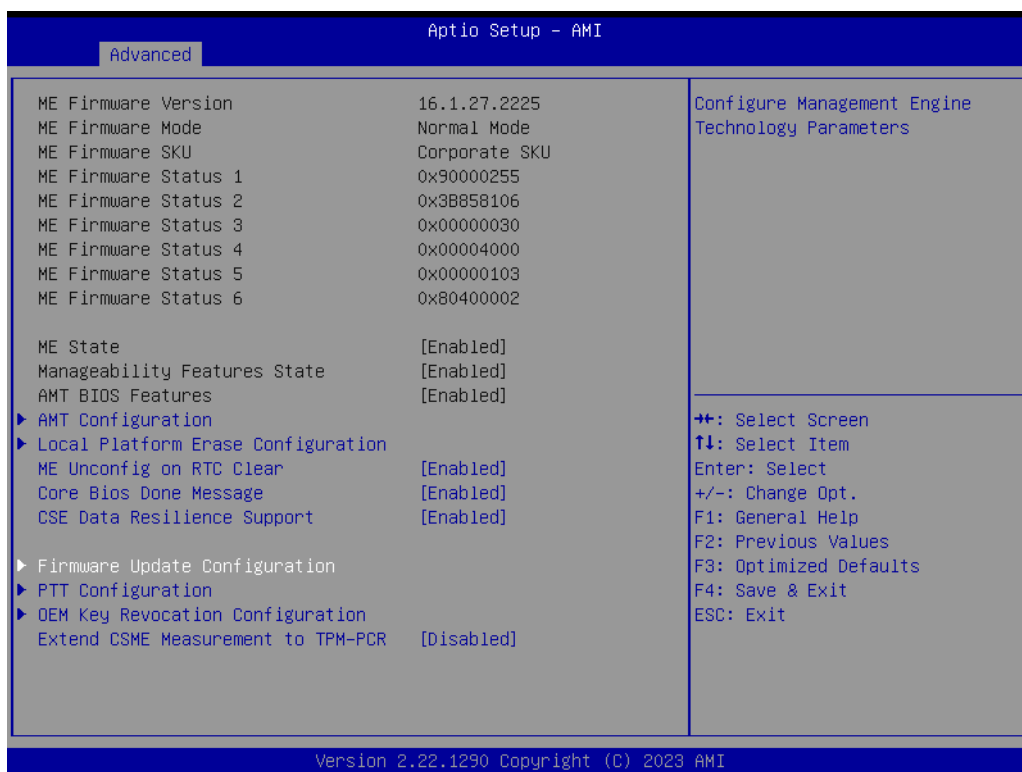

Figure 3.12



Figure 3.13

- **ME State**
When Disabled ME will be put into ME Temporarily Disabled Mode.
- **Manageability Features State**
Enable/Disable Intel(R) Manageability features.

- **AMT BIOS Features**

When disabled AMT BIOS Features are no longer supported and user is no longer able to access MEBx Setup.

- **ME Unconfig on RTC Clear**

When Disabled ME will not be unconfigured on RTC Clear.

Firmware Update Configuration

- **Me FW Image Re-Flash**

Enable/Disable Me FW Image Re-Flash function.

- **FW Update**

Enable/Disable ME FW Update function.

OEM Flags Settings

- **MEBx hotkey Pressed**

Enable automatic MEBx hotkey press.

- **MEBx Selection Screen**

Enable MEBx selection screen with 2 options: Press 1 to enter ME Configuration Screens. Press 2 to initiate a remote connection.

- **Hide Unconfigure ME Confirmation Prompt**

Hide Unconfigure ME confirmation prompt when attempting ME unconfiguration.

- **MEBx OEM Debug Menu Enable**

Enable OEM debug menu in MEBx.

- **Unconfigure ME**

Unconfigure ME with resetting MEBx password to default.

3.2.2.5 ACPI Settings

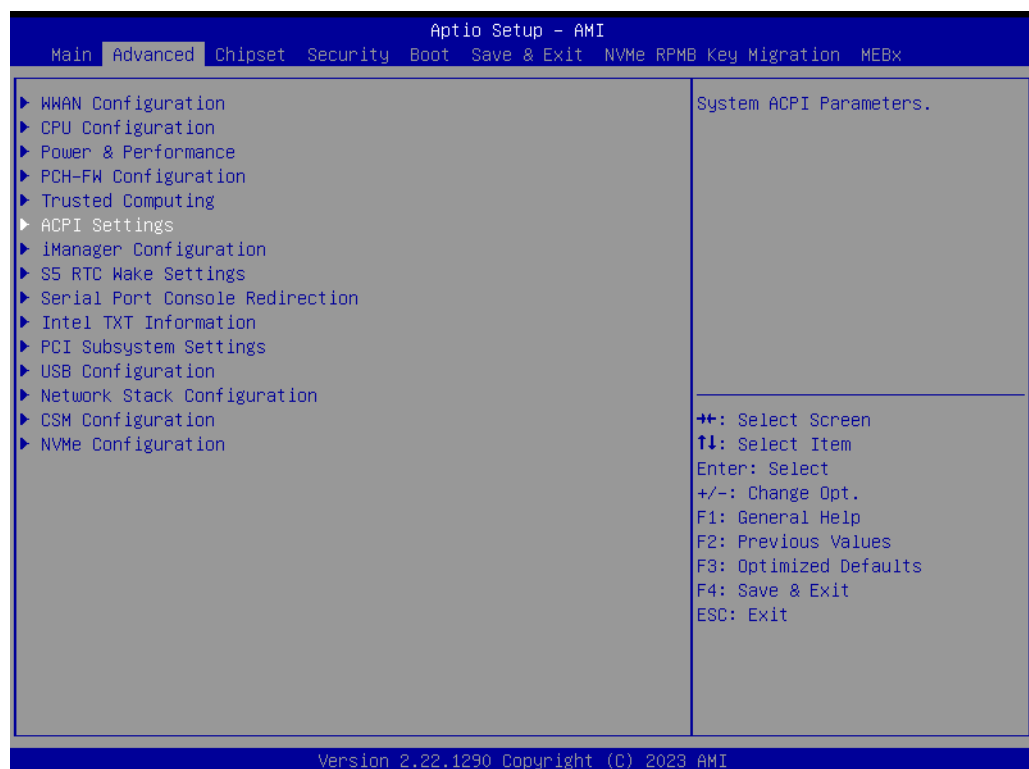

Figure 3.14

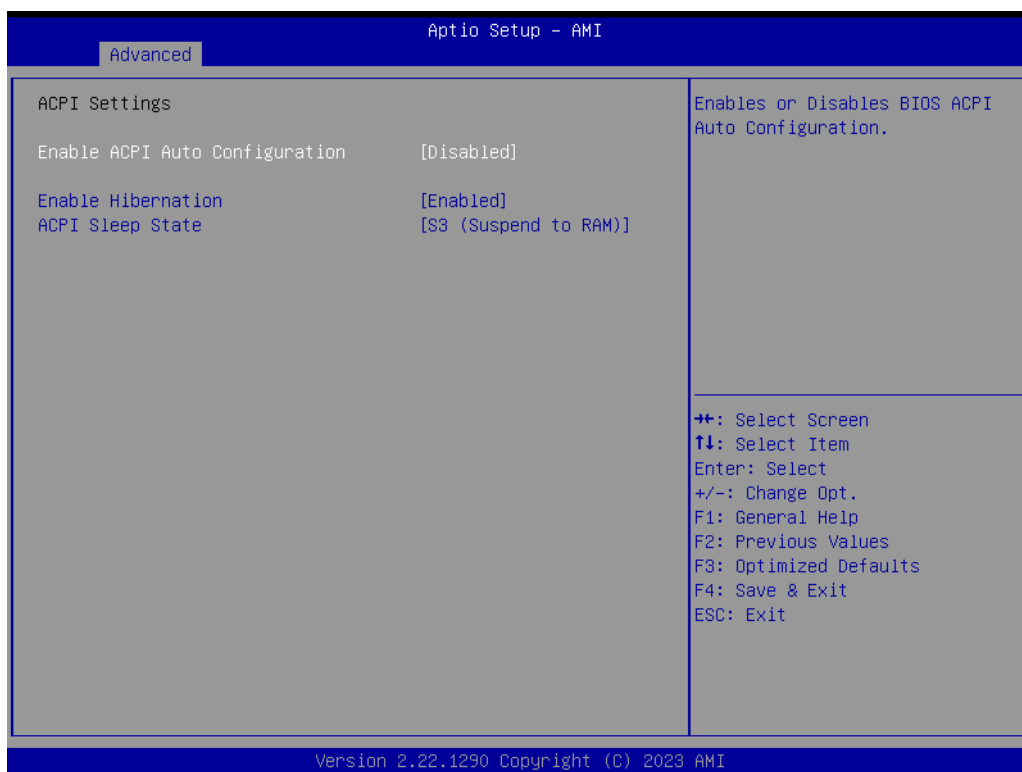

Figure 3.15

- **Enable ACPI Auto Configuration**
Enables or Disables BIOS ACPI Auto Configuration.
- **Enable Hibernation**
Enables or Disables System ability to Hibernate (OS/S4 Sleep State). This option may not be effective with some operating systems.
- **ACPI Sleep State**
Select the highest ACPI sleep state the system will enter when the SUSPEND button is pressed.

3.2.2.6 iManager Configuration

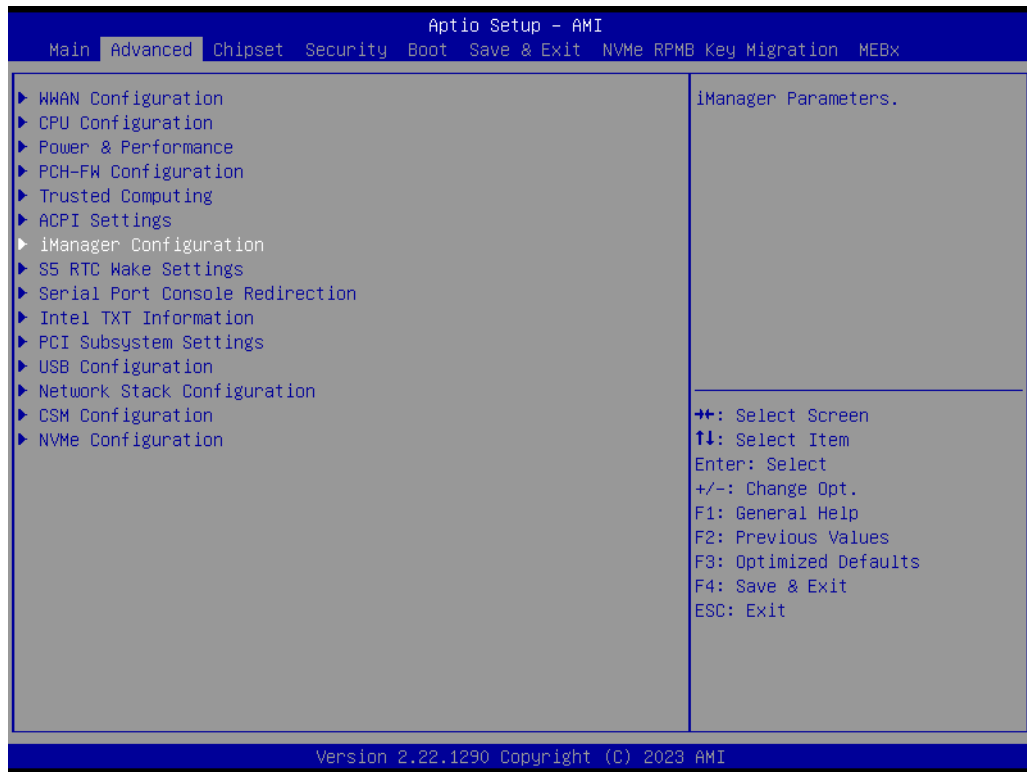

Figure 3.16

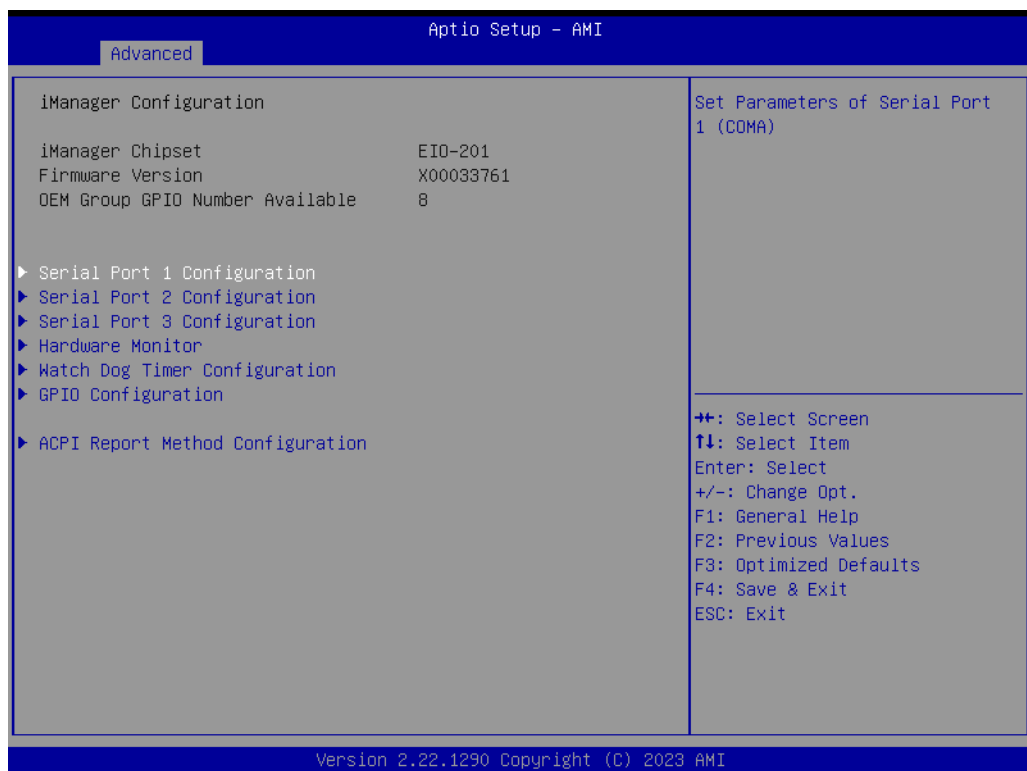

Figure 3.17

Serial Port 1 Configuration

■ Serial Port

Enable or Disable serial port.

- **Change Settings**
Select an optional settings for Super IO device.
- **COM1 Mode**
COM1 mode select.

Serial Port 2 Configuration

- **Serial Port**
Enable or Disable serial port.
- **Change Settings**
Select an optional settings for Super IO device.
- **COM2 Mode**
COM2 mode select.

Hardware Monitor

Provide hardware monitor information.

Watch Dog Timer Configuration

- **Watch Dog Timer**
Enabled or Disabled.

Watch Dog Timer function (Start before boot to OS and must stop by self).

GPIO Configuration

- **GPIO Control Enable**
Choose to control GPIO by EC or user override during POST stage.

ACPI Report Method Control

Select ACPI Reporting Method for EC Devices.

3.2.2.7 Trusted Computing

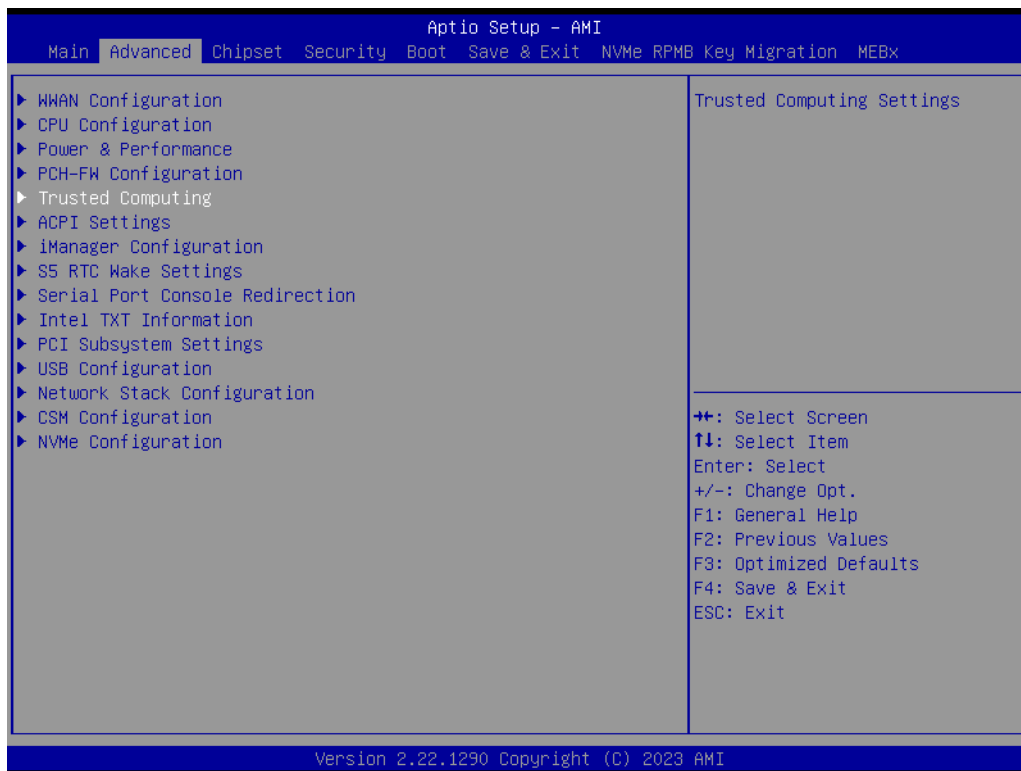

Figure 3.18

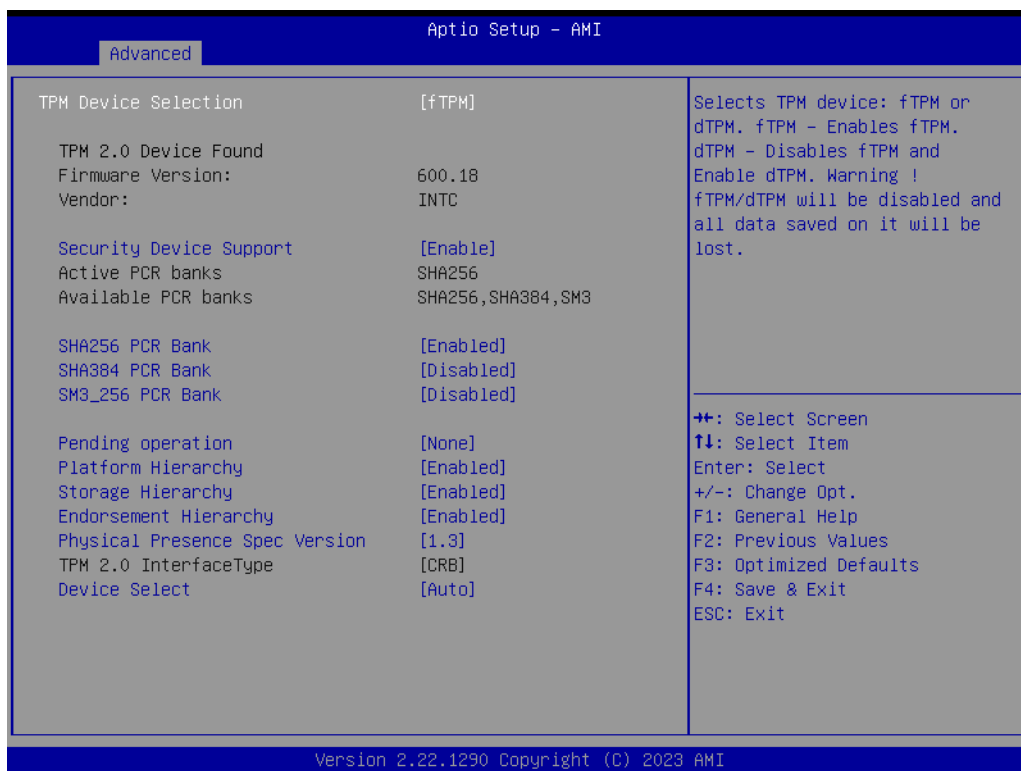

Figure 3.19

- **Security Device Support**
Enables or Disables BIOS support for security device.
- **SHA256 PCR Bank**

Enable or Disable SHA256 PCR Bank.

- **Pending operation**

Schedule an Operation for the security device.

- **Platform Hierarchy**

Enable or Disable Platform Hierarchy.

- **Storage Hierarchy**

Enable or Disable Storage Hierarchy.

- **Endorsement Hierarchy**

Enable or Disable Endorsement Hierarchy.

- **Physical Presence Spec Version**

Select to Tell O.S. to support PPI Spec Version 1.2 or 1.3. Note some HCK tests might not support 1.3.

3.2.2.8 S5 RTC Wake Settings

- **Wake System from S5**

Enable or disable System wake on alarm event. When enabled, System will wake on the hr::min::sec specified.

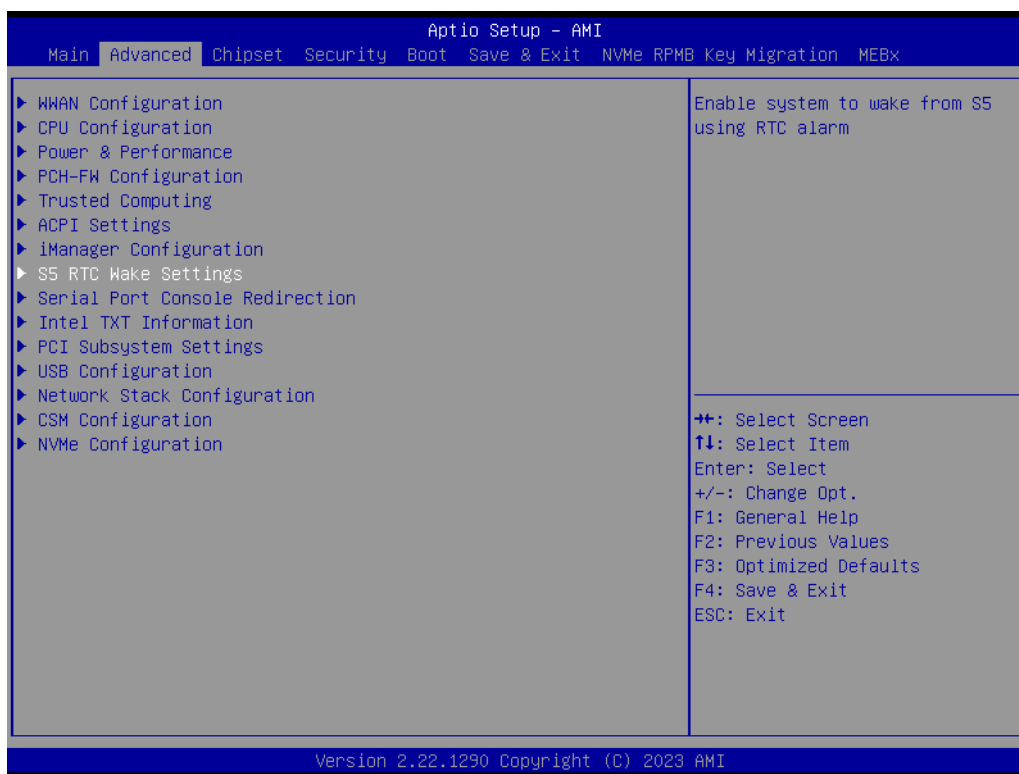

Figure 3.20

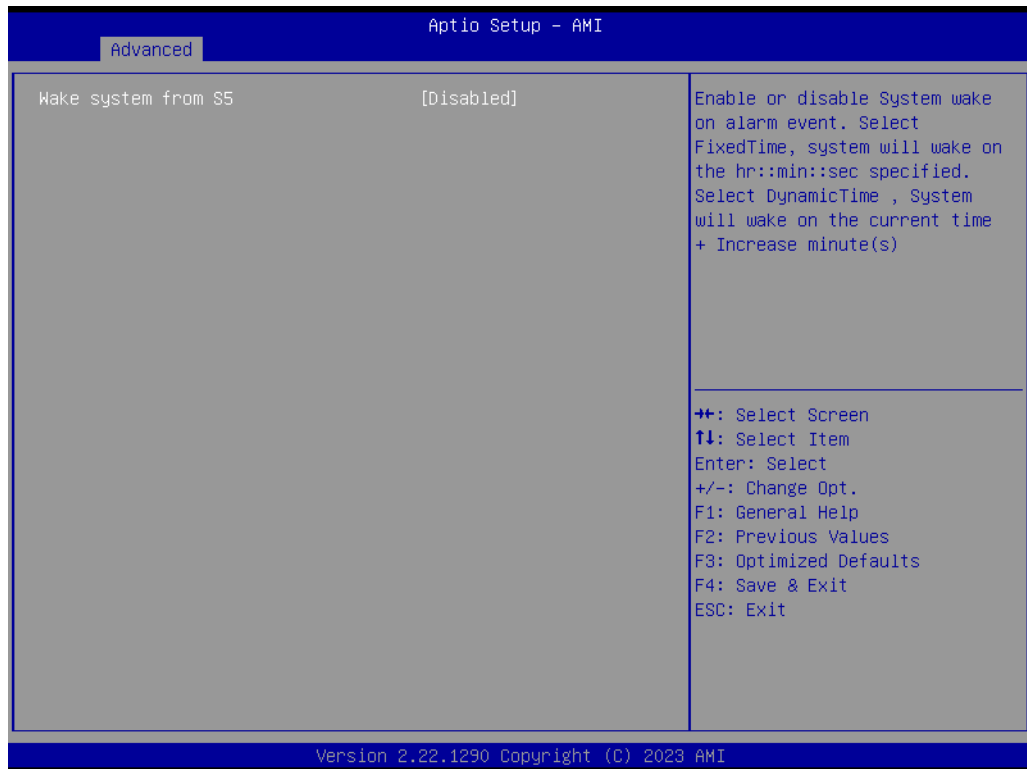

Figure 3.21

3.2.2.9 Serial Port Console Redirection

- **Console Redirection**
Console Redirection Enable or Disable.



Figure 3.22

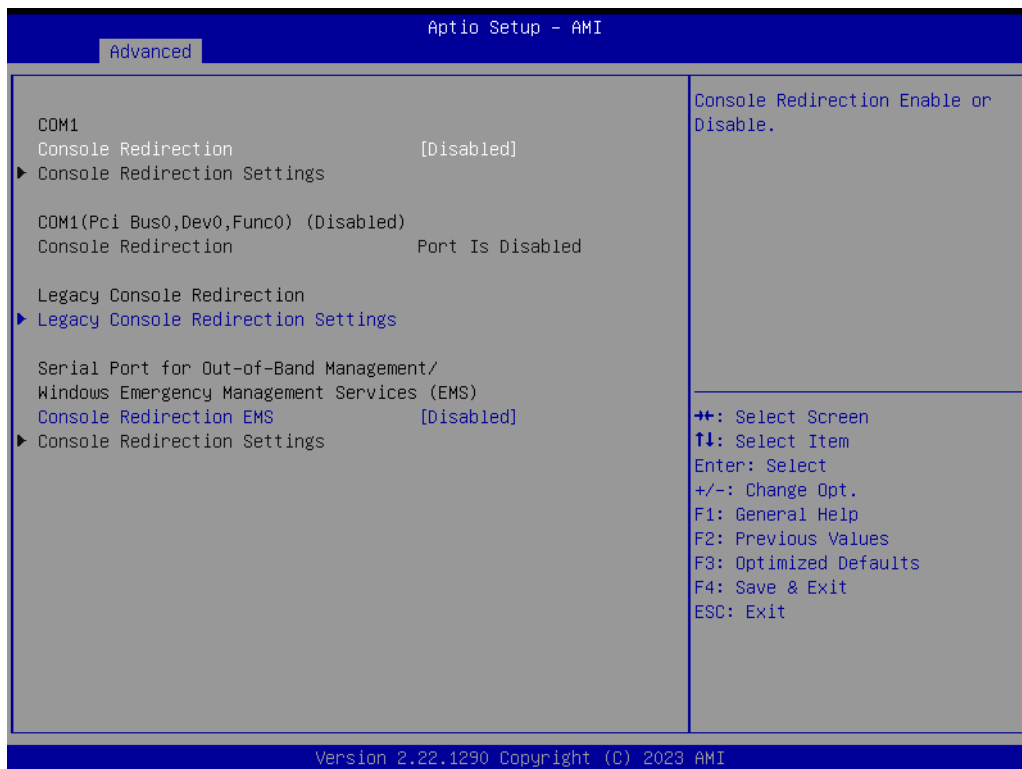

Figure 3.23

3.2.2.10 Intel TXT Information



Figure 3.24

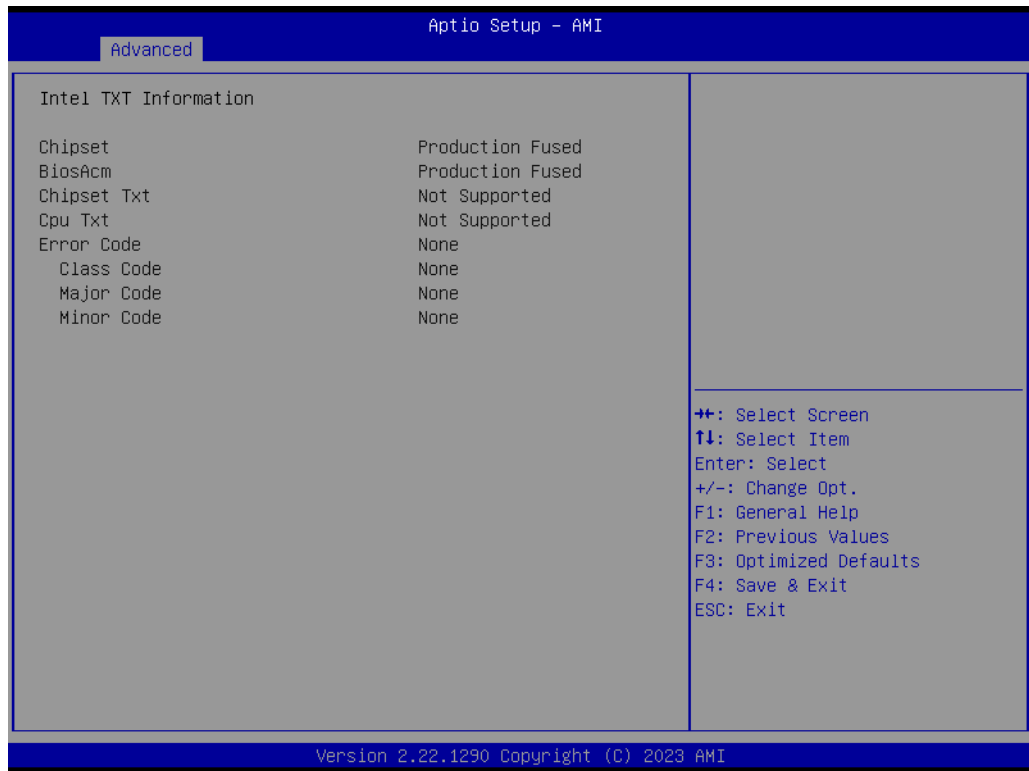

Figure 3.25

Provide Intel TXT information.

3.2.2.11 PCI Subsystem Settings



Figure 3.26

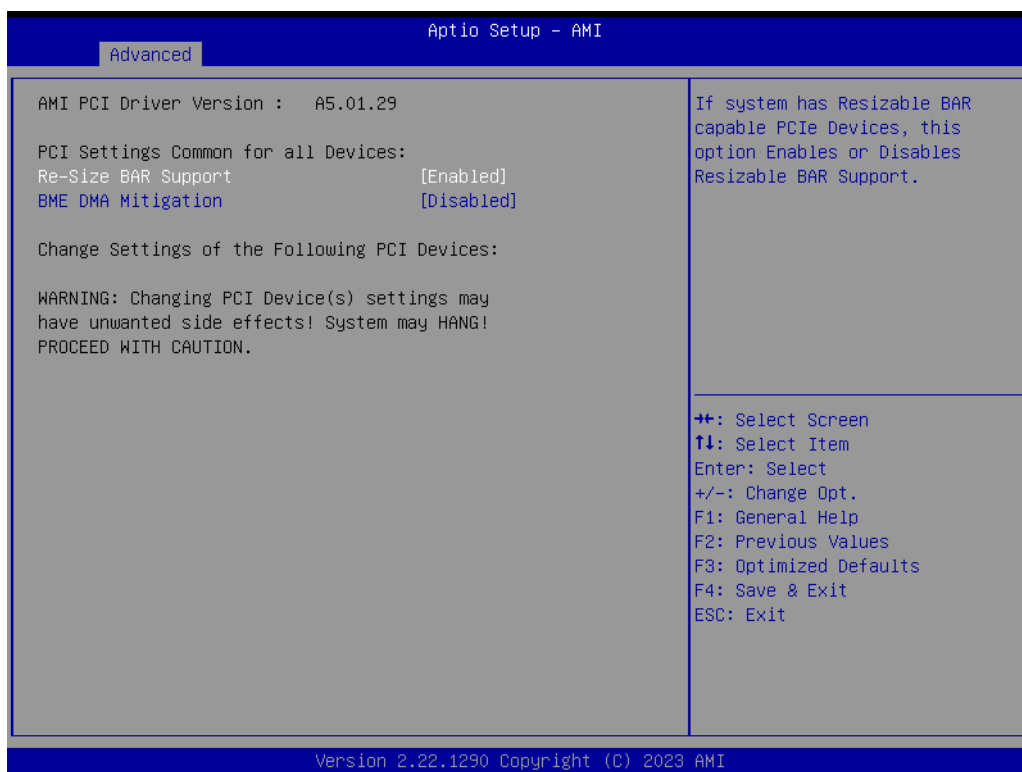

Figure 3.27

- **Re-Sized BAR Support**
If system has Resizable BAR capable PCIe Devices, this option Enables or Disables Resizable BAR Support.
- **BME DMA Mitigation**
Re-enable Bus Master Attribute disabled during Pci enumeration for PCI Bridges after SMM Locked.

3.2.2.12 USB Configuration

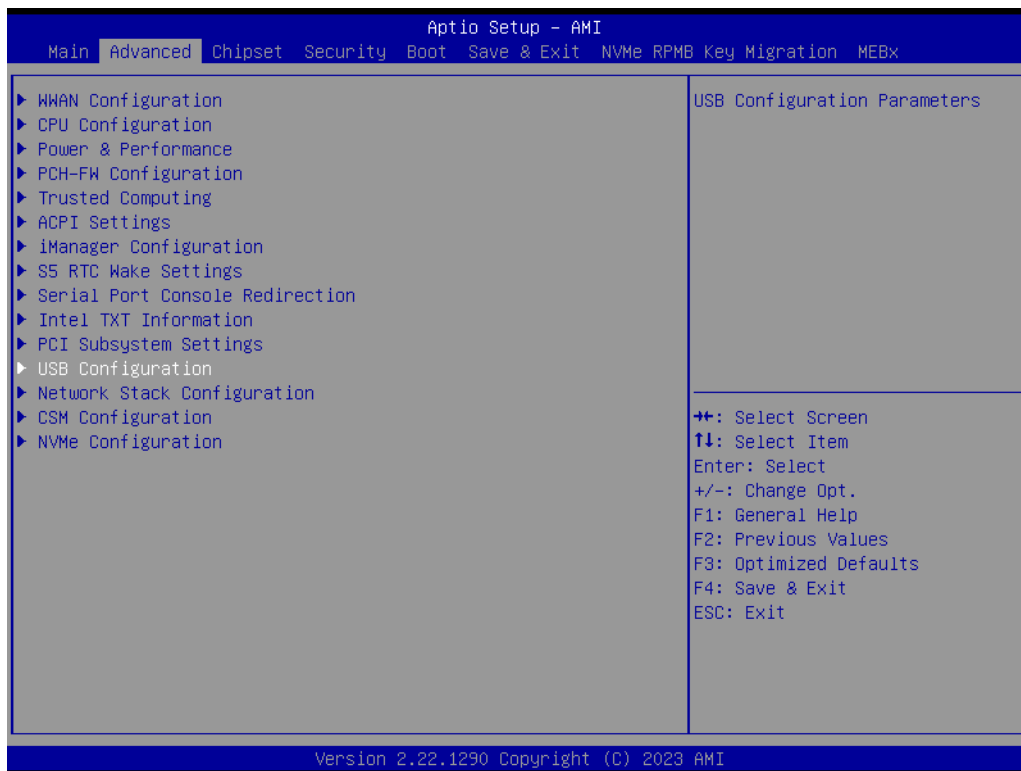

Figure 3.28

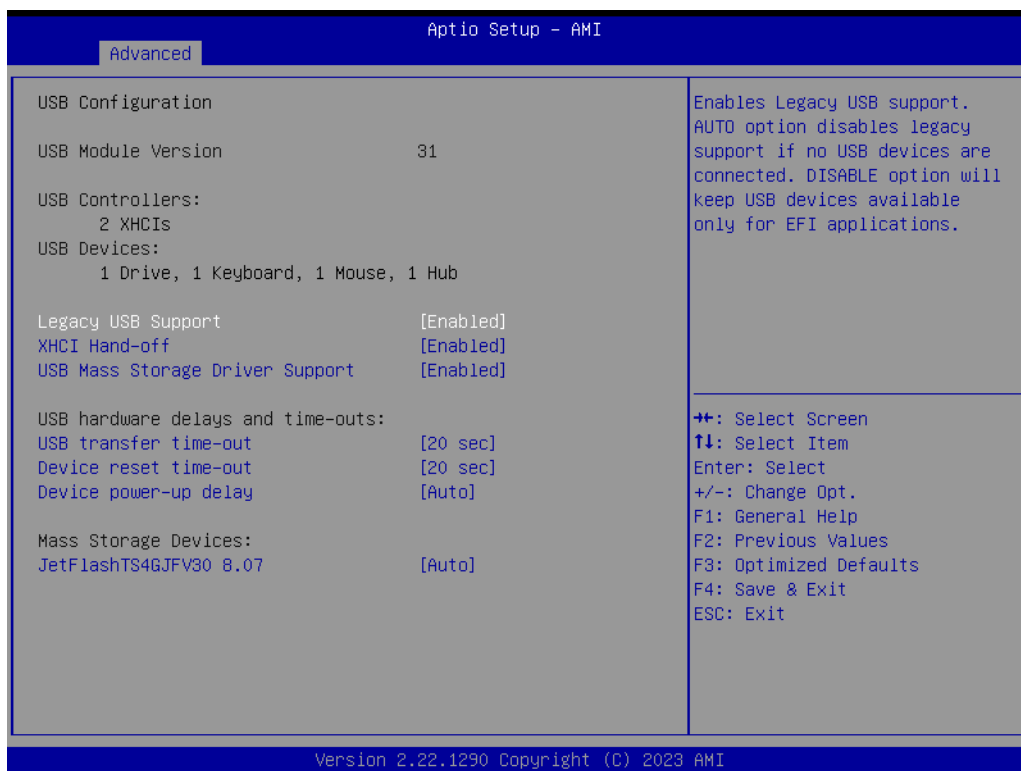

Figure 3.29

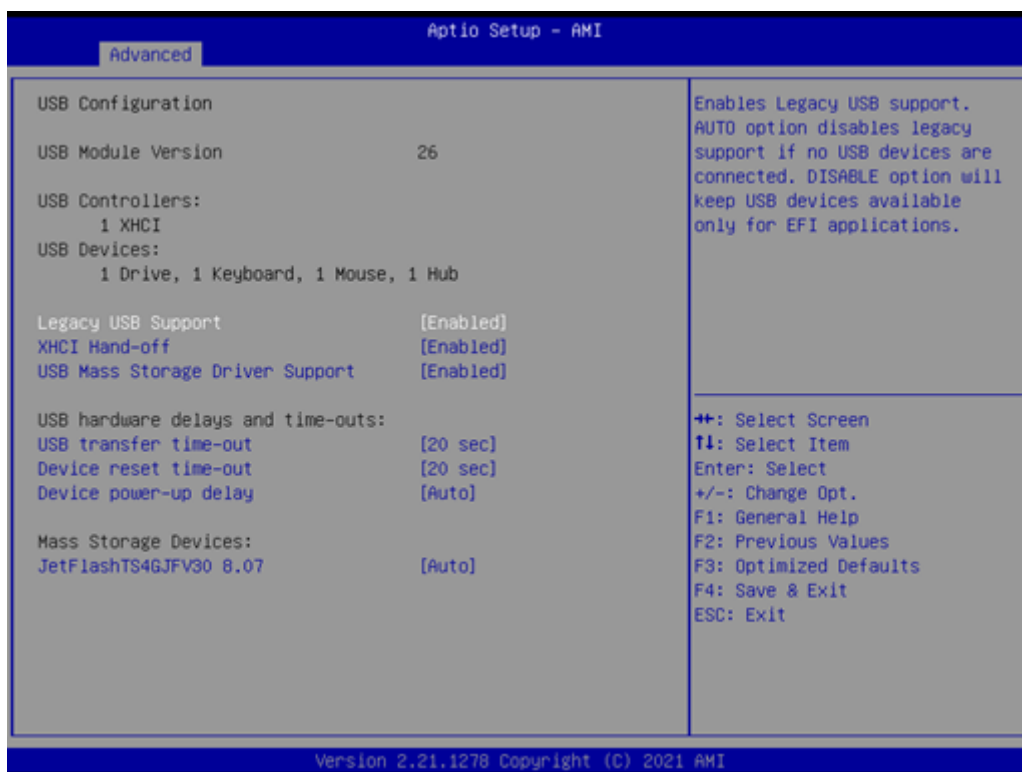

Figure 3.30

- **Legacy USB Support**
Enables Legacy USB support.
- **XHCI Hand-Off**
This is a workaround for Oses without XHCI hand-off support.
USB Mass Storage Driver Support: Enable/Disable USB Mass Storage Driver Support.
- **USB transfer time-out**
The time-out value for Control, Bulk, and Interrupt transfers.
- **Device Reset Timeout**
USB mass storage device Start Unit command time-out.
- **Device Power-Up Delay**
Maximum time the device will take before it properly reports itself to the Host Controller.

3.2.2.13 Network Stack Configuration

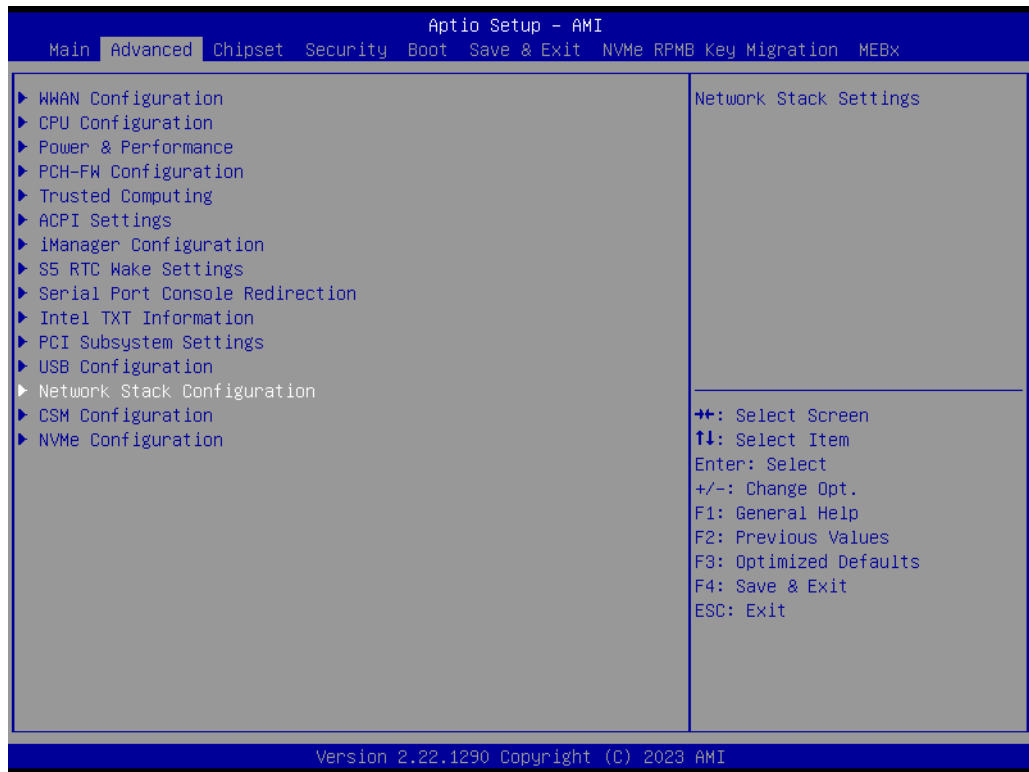

Figure 3.31

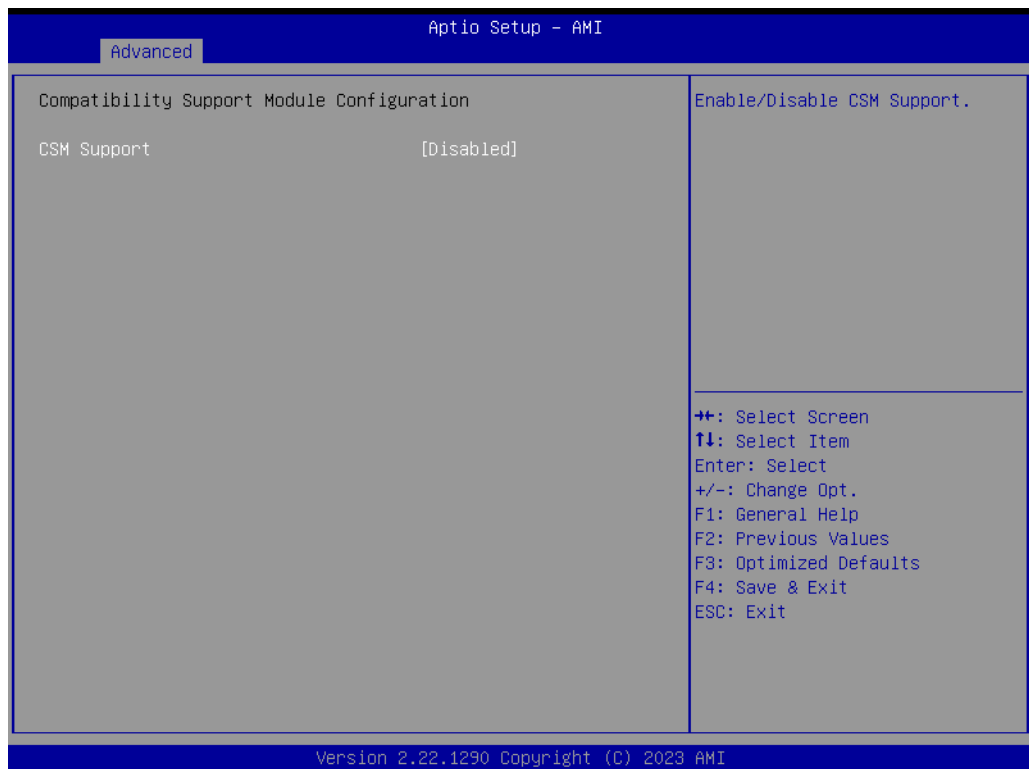

Figure 3.32

- **Network Stack**
Enable/Disable UEFI network stack.

3.2.2.14 CSM Configuration



Figure 3.33

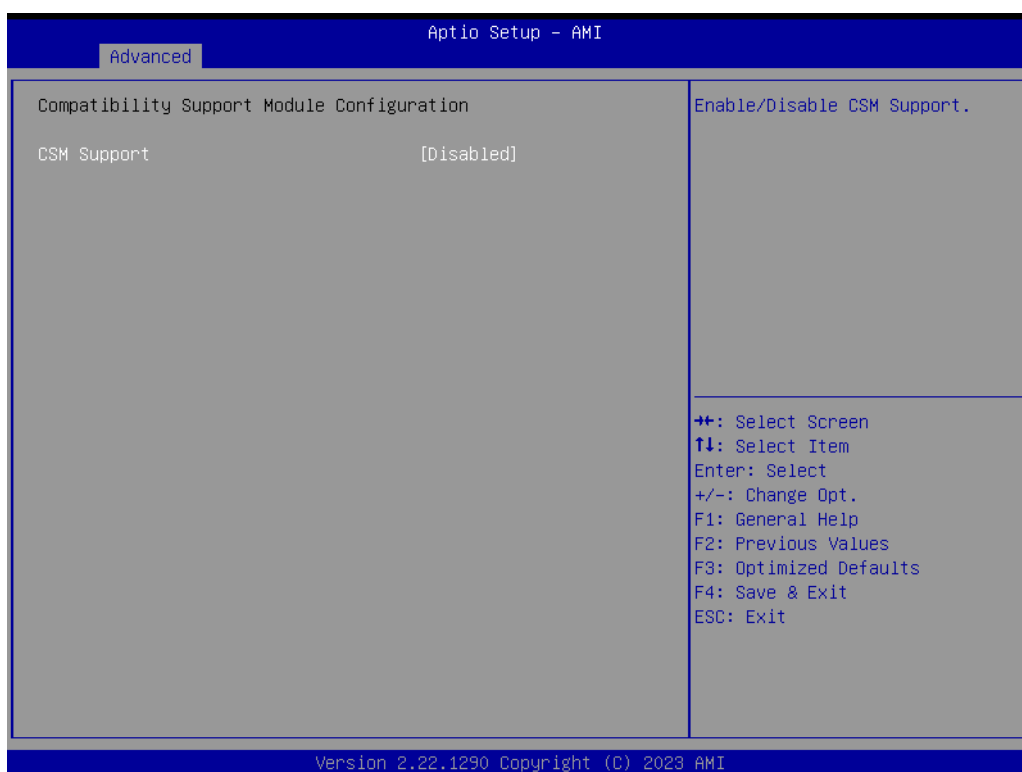

Figure 3.34

- **CSM Support**
Enable/Disable CSM support.

3.2.3 Chipset Configuration

3.2.3.1 System Agent (SA) Configuration

Memory Configuration

Display memory information.

- **VT-d**

VT-d capability.

- **Above 4GB MMIO BIOS assignment**

Enable/Disable above 4GB MemoryMappedIO BIOS assignment. This is enabled automatically when Aperture Size is set to 2048MB.



Figure 3.35

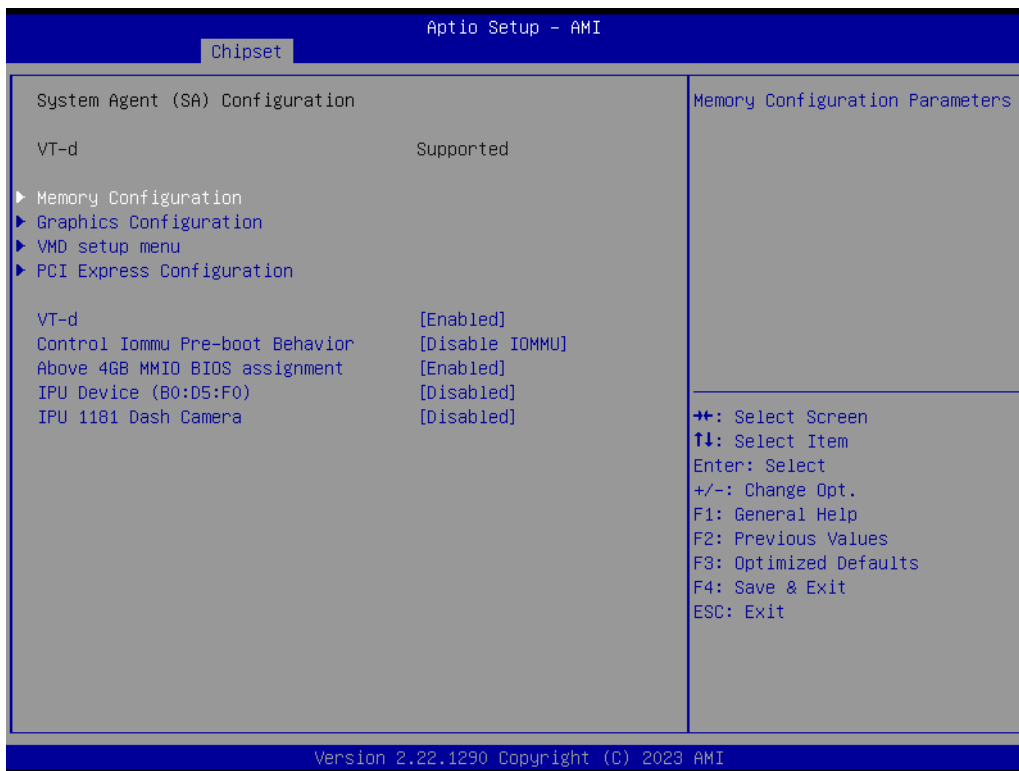

Figure 3.36

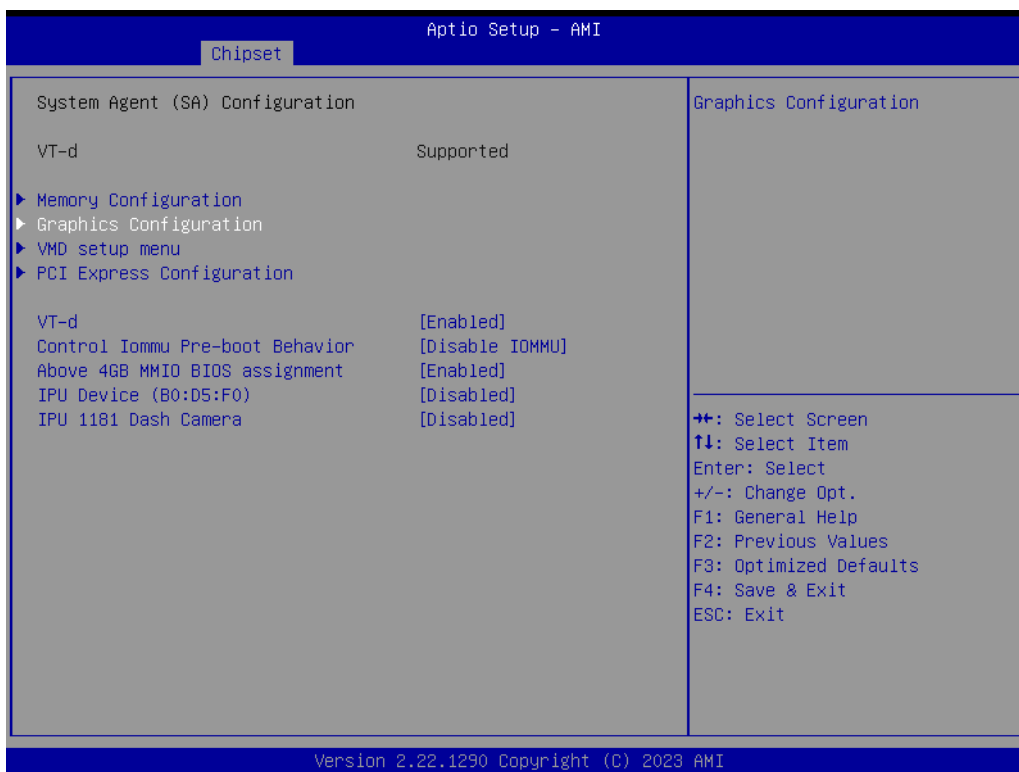

Figure 3.37

Graphics Configuration

- **Dvmt Total Gfx Mem**
256MB.

Select DVMT5.0 Total Graphic Memory size used by the Internal Graphics Device.

- **RAV Enable**

Enabled

VMD setup menu

- VMD Configuration settings

PCI Express Configuration

- **PCI Express Root Port 1**

Select to enable or disable M.2 M Key.

3.2.3.2 PCH-IO Configuration



Figure 3.38

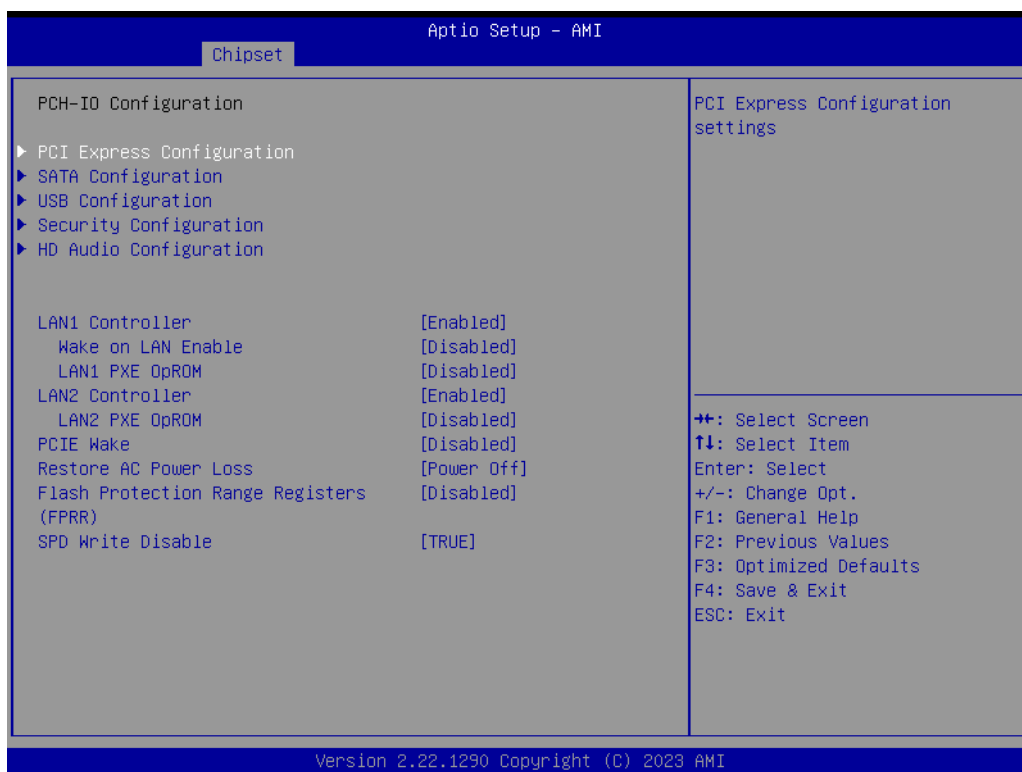

Figure 3.39

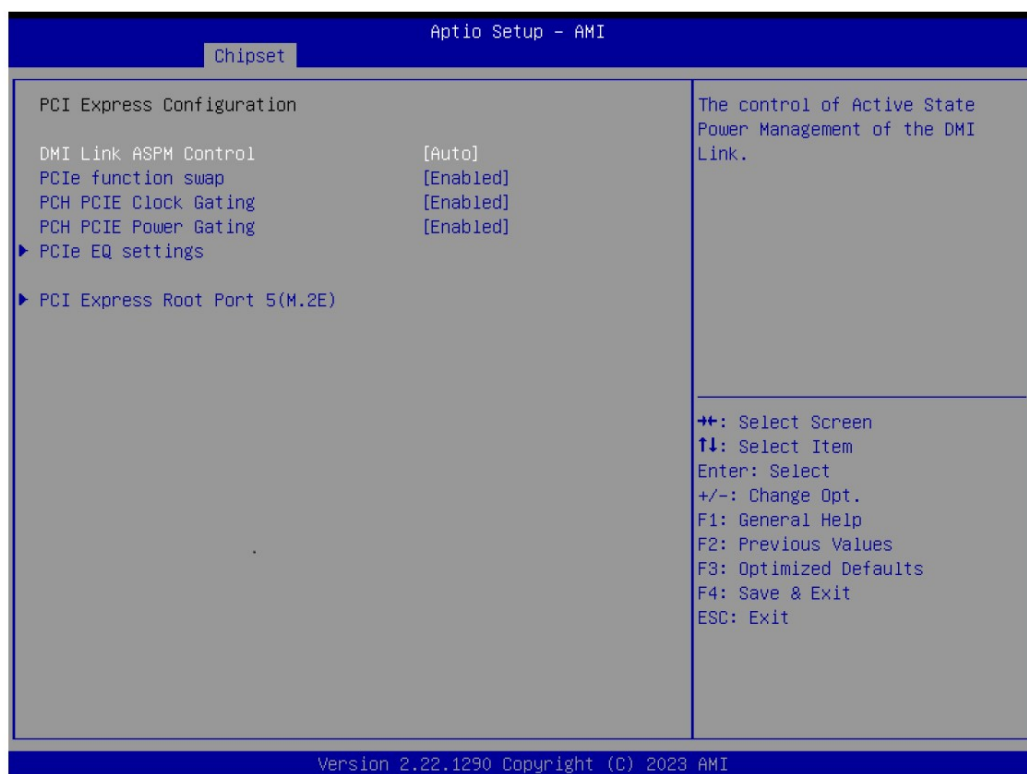

Figure 3.40

PCI Express Configuration

■ PCH PCIe Clock Gating

Select to enable, PCH PCI Express Clock Gating Enable/Disable for all port.

- **PCH PCIE Power Gating**
PCH PCI Express Power Gating Enable/Disable for all port.
- **PCIe EQ settings**
This form contains options for controlling PCIe EQ process.

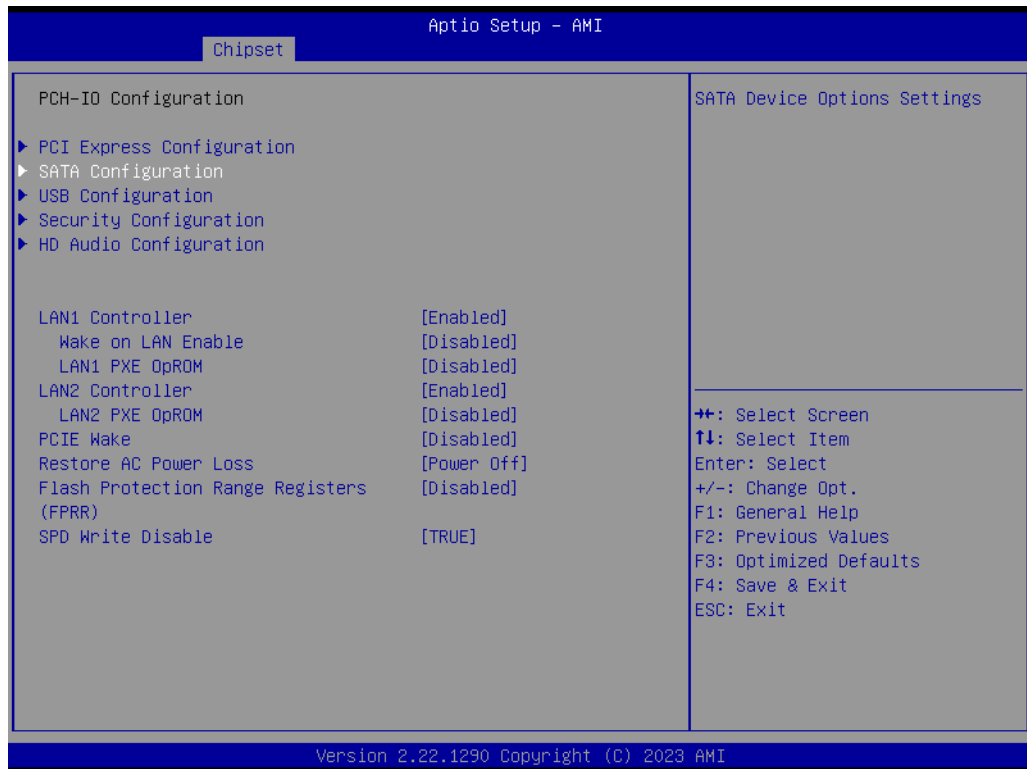

Figure 3.41

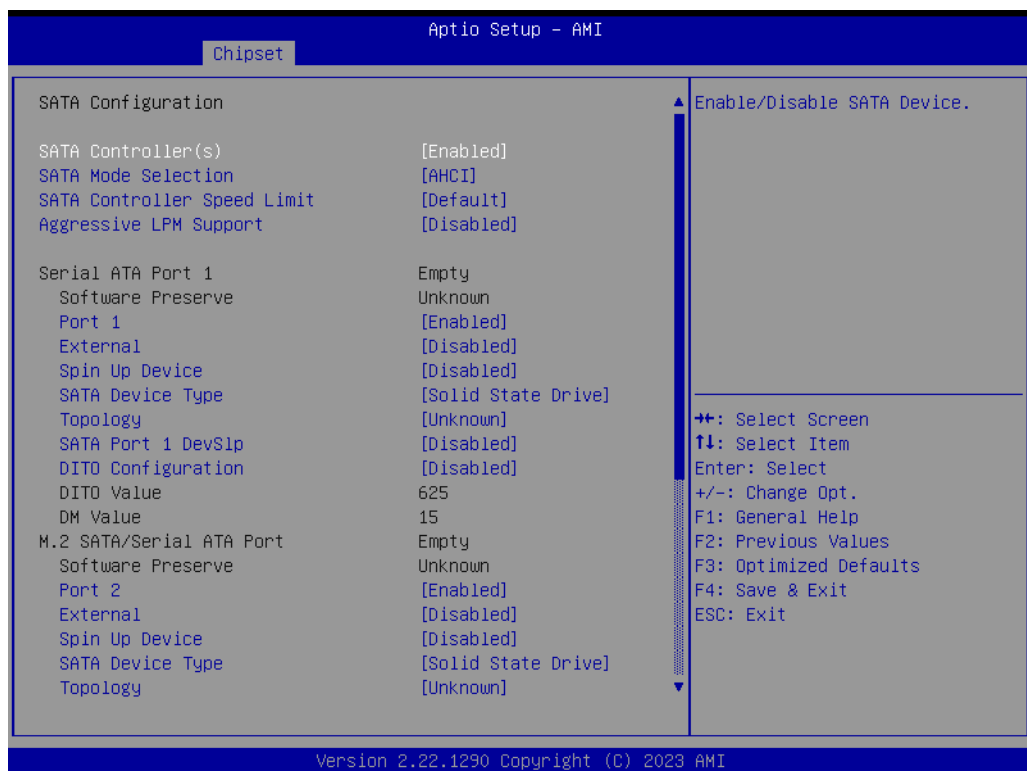

Figure 3.42

SATA Configuration

- **SATA Controller(s)**
Enable/Disable SATA Device.
- **Spin Up Device**
If enabled for any of ports Staggered Spin Up will be performed and only the drives which have this option enabled will spin up at boot. Otherwise all drives spin up at boot.
- **SATA Device Type**
Identify the SATA port is connected to Solid State Drive or Hard Disk Drive.
- **Topology**
Identify the SATA Topology if it is Default or ISATA or Flex or DirectConnect or M2.
- **DITO Configuration**
Enable/Disable DITO Configuration.

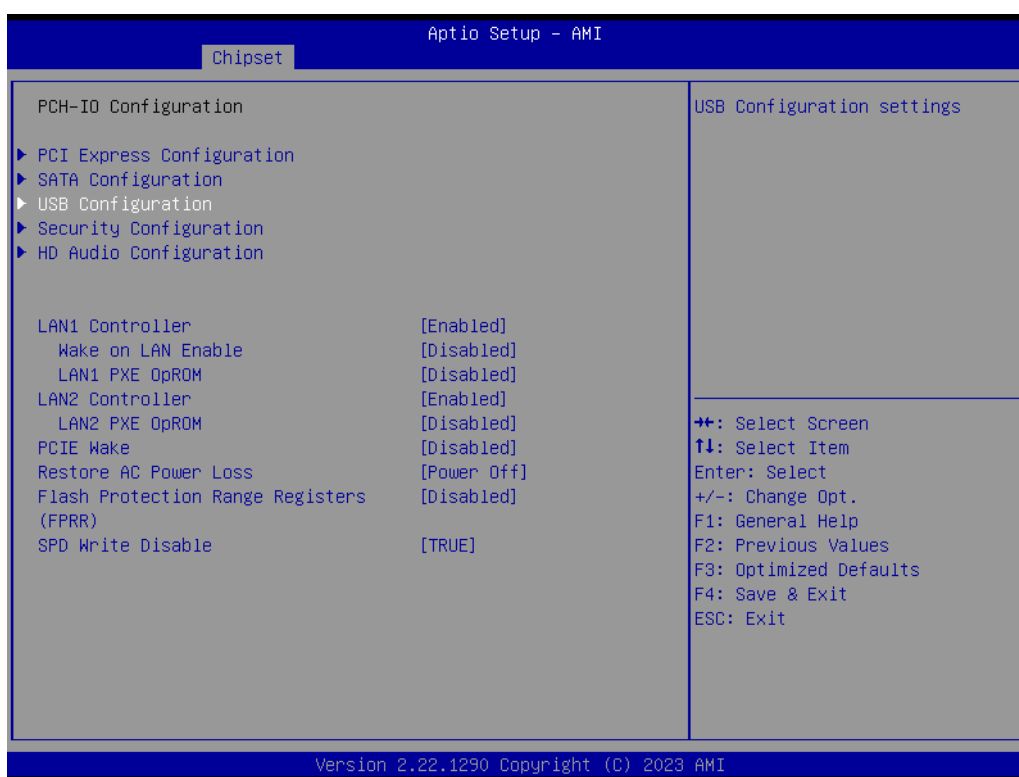

Figure 3.43



Figure 3.44

USB Configuration

- **USB PDO Programming**
Select 'Enabled' if Port Disable Override functionality is used.
- **USB Overcurrent**
Select 'Disabled' for pin-based debug.
- **USB Overcurrent Lock**
Select 'Enabled' if Overcurrent functionality is used. Enabling this will make xHCI controller consume the Overcurrent mapping data.
- **USB Port Disable Override**
Selectively Enable/Disable the corresponding USB port from reporting a Device Connection to the controller.

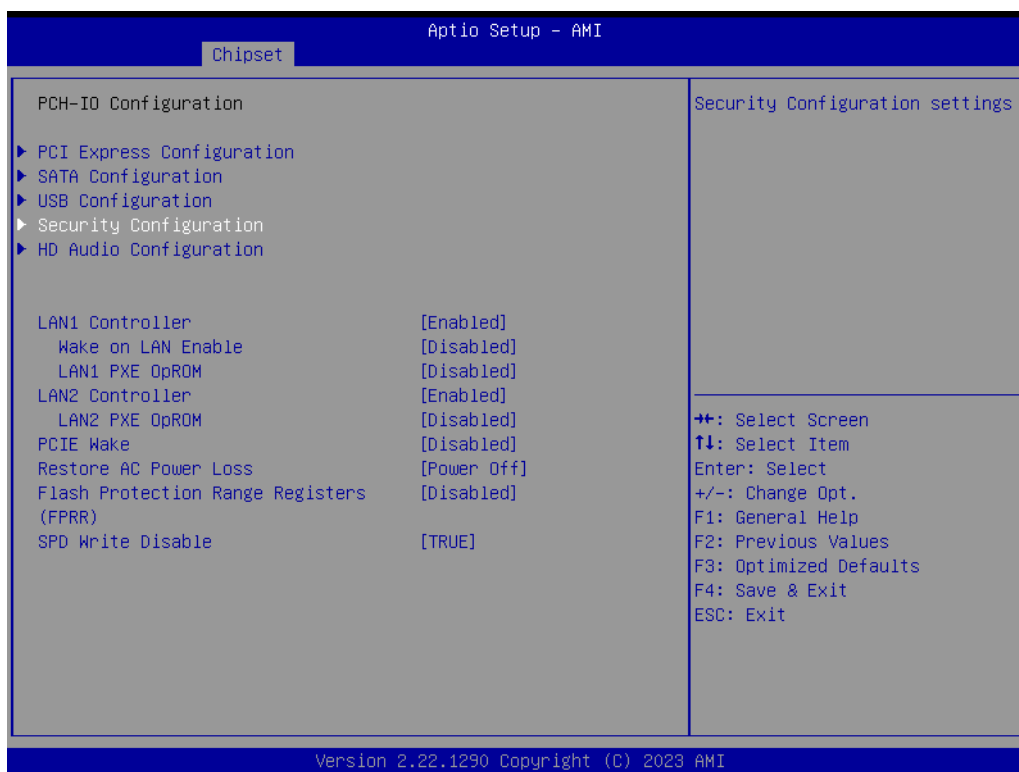

Figure 3.45



Figure 3.46

Security Configuration

- **RTC Memory Lock**

Enable will lock bytes 38h-3Fh in the lower/upper 128-byte bank of RTC RAM.

- **BIOS Lock**

Enable/Disable the PCH BIOS Lock Enable feature. Required to be enabled to ensure SMM protection of flash.

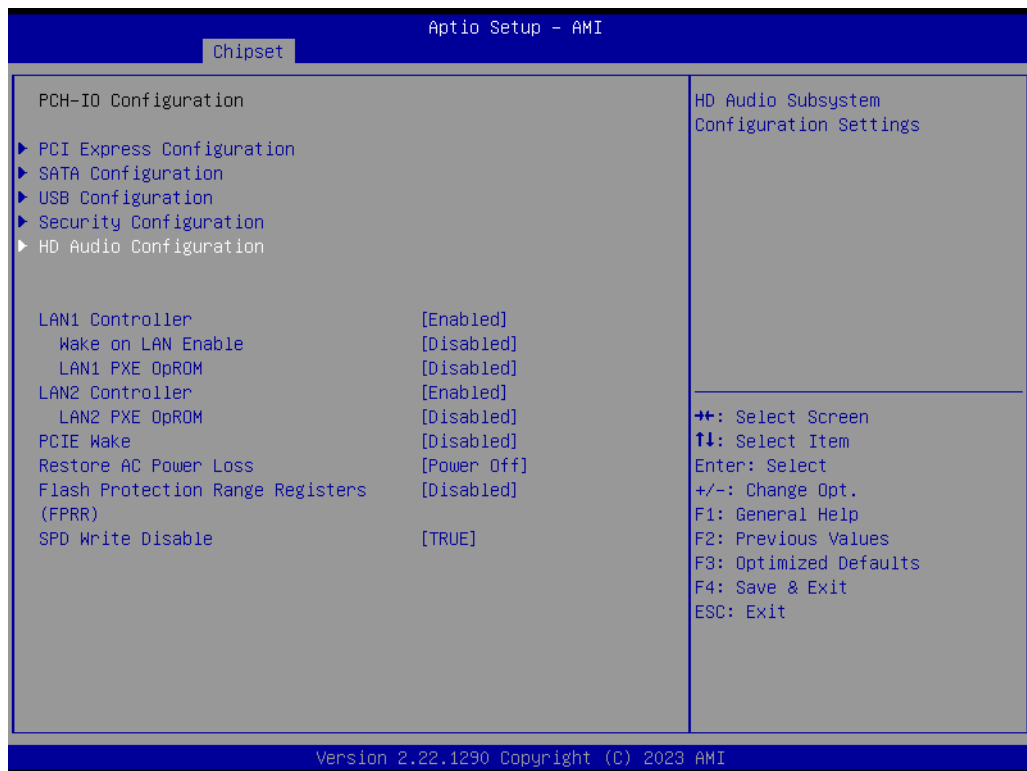

Figure 3.47



Figure 3.48

HD Audio Configuration

■ HD Audio

Control Detection of the HD-Audio device.

PCH LAN Controller

Enable/Disable onboard NIC.

LAN1 PXE OpROM

Enable or disable boot option for LAN1 Controller.

Wake on LAN Enable

Enable/Disable integrated LAN to wake the system.

Onboard LAN2 Controller

Select to Enable or Disable Onboard LAN2 Controller.

LAN2 PXE OpROM

Enable or disable boot option for LAN2 Controller.

PCIE Wake

Enable or disable PCIE to wake the system from S5.

Restore AC Power Loss

Specify what state to go to when power is re-applied after a power failure (G3 state).

3.2.4 Security

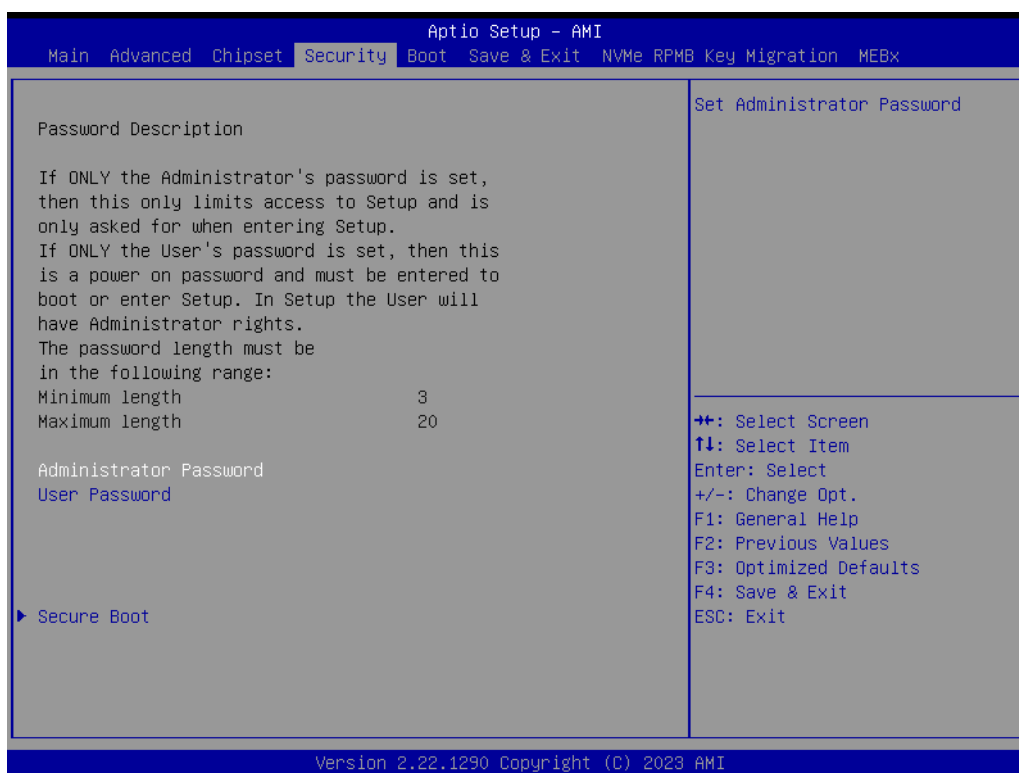

Figure 3.49

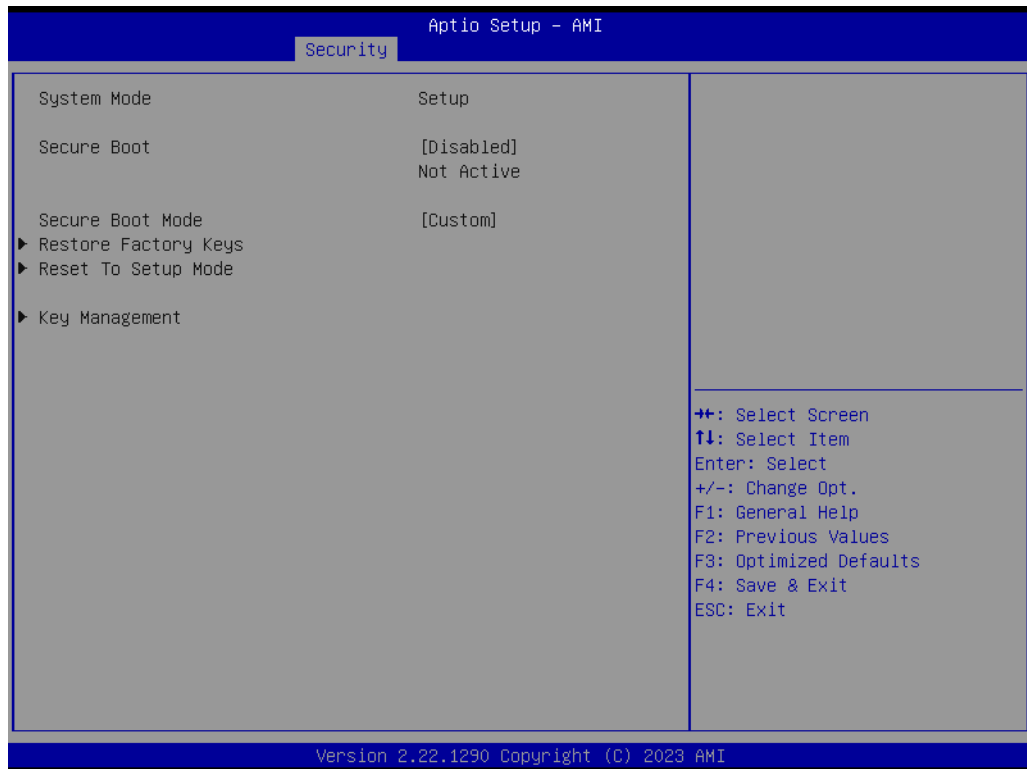

Figure 3.50

Security

- **Administrator Password**
Set Administrator Password.
- **User Password**
Set User Password.
- **Secure Boot Mode**
Secure Boot mode options: Standard or Custom.
- **Restore Factory Keys**
Force System to User Mode. Install factory default Secure Boot key databases.
- **Reset To Setup Mode**
Delete all Secure Boot key databases from NVRAM.
- **Key Management**
Enables expert users to modify Secure Boot Policy variables without variable authentication.

3.2.5 Boot



Figure 3.51

Boot

- **Setup Prompt Timeout**
Number of seconds to wait for setup activation key.
- **Bootup NumLock State**
Select the keyboard NumLock state.
- **Quiet Boot**
Enables or disables Quiet Boot option.

3.2.6 Save & Exit

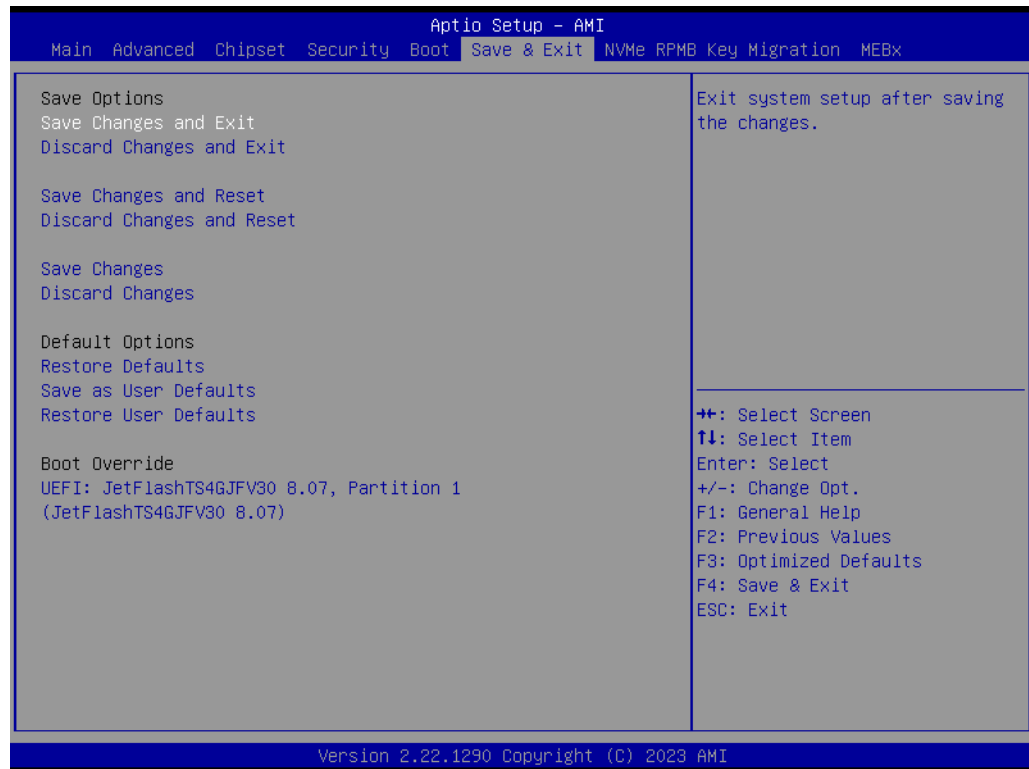

Figure 3.52

- **Changes and Exit**
Exit system setup after saving the changes.
- **Discard Changes and Exit**
Exit system setup without saving any changes.
- **Save Changes and Reset**
Reset the system after saving the changes.
- **Discard Changes and Reset**
Reset system setup without saving any changes.
- **Save Changes**
Save Changes done so far to any of the setup options.
- **Discard Changes**
Discard Changes done so far to any of the setup options.
- **Restore Defaults**
Restore/Load Default values for all the setup options.
- **Save as User Defaults**
Save the changes done so far as User Defaults.
- **Restore User Defaults**
Restore the User Defaults to all the setup options.

3.2.7 NVMe RPMB KEY Migration



Figure 3.53

3.2.8 MEBX



Figure 3.54

ADVANTECH

Enabling an Intelligent Planet

www.advantech.com

Please verify specifications before quoting. This guide is intended for reference purposes only.

All product specifications are subject to change without notice.

No part of this publication may be reproduced in any form or by any means, such as electronically, by photocopying, recording, or otherwise, without prior written permission from the publisher.

All brand and product names are trademarks or registered trademarks of their respective companies.

© Advantech Co., Ltd. 2023