

# Rugged Laptop L156 Series



**Model no.** L156AD  
L156AD-M1  
L156AD-4KM1

# User Manual

---

# Contents

<b>Contents</b> .....	<b>1</b>
<b>Preface</b> .....	<b>4</b>
<b>Chapter 1: Getting Started</b> .....	<b>8</b>
1.1 Overview.....	8
1.2 Package Content .....	8
1.3 Product Overview.....	9
1.4 Mechanical Dimension.....	12
1.5 Hardware Installation .....	12
1.5.1 Installing a Micro SD Card.....	12
1.6 Battery .....	14
1.6.1 Installing and Removing the Batteries .....	14
1.6.2 Checking the Remaining Battery Power .....	15
1.6.3 Connecting to AC Power .....	16
1.6.4 Important Battery Tips .....	17
1.7 Turning On/Off .....	18
1.7.1 Turning On the Computer.....	18
1.7.2 Sleep/Hibernation Functions .....	18
1.7.3 Turning Off the Rugged Laptop .....	21
<b>Chapter 2: Operating Your Rugged Laptop</b> .....	<b>22</b>
2.1 Using the Keyboard .....	22
2.1.1 Typewriter Keys .....	22
2.1.2 Cursor-Control Keys.....	23
2.1.3 Numeric Keypad.....	23
2.1.4 Function Keys .....	23
2.1.5 Fn Key.....	23
2.1.6 Hot Keys .....	23
2.1.7 Windows Keys.....	24
2.1.8 Keyboard Backlight Settings.....	25
2.2 Using the Touchpad.....	26
2.2.1 Touch Gestures.....	26
2.2.2 Disabling/Enabling the Touchpad.....	27
2.2.3 Changing the Cursor Speed of Touchpad .....	27
2.2.4 Handling the Touchpad .....	27
2.3 Using the Touchscreen .....	28
2.3.1 Changing Touchscreen Modes.....	28
2.3.2 Touch Gestures.....	29
2.4 Using Physical Button .....	30

2.5 Turn On/Off LED Indicator .....	30
2.6 Using Smart Card Reader.....	30
2.6.1 Inserting/Removing the Smart Card.....	31
<b>Chapter 3: Configuring the Rugged Laptop.....</b>	<b>32</b>
3.1 BIOS Utility .....	32
3.1.1 Boot sequence .....	32
3.1.2 Setting passwords.....	32
3.2 Setting Up Windows 10 IoT Enterprise.....	32
3.3 Hottab Introduction.....	35
3.4 Hottab Utility Setting .....	37
3.4.1 PC Information .....	37
3.4.2 Check for Update .....	37
3.4.3 Function Keys .....	38
3.4.4 Touch Mode .....	39
3.4.5 Keyboard LED.....	39
3.4.6 Brightness .....	40
3.4.7 Volume.....	40
3.5 Using Camera.....	41
3.5.1 Enable Camera Interface with Hottab Utility .....	41
3.5.2 Open Camera Interface.....	41
3.6 Using Fingerprint Scanner .....	42
3.6.1 Precaution.....	42
3.6.2 Using Fingerprint Scanner with Hottab Utility.....	44
3.6.3 Fingerprint Authentication Function .....	44
3.7 HF RFID .....	45
3.7.1 RFID Trigger Setting .....	46
3.7.2 Settings.....	47
3.7.3 RFID Output Setting.....	49
3.8 Power Saving.....	50
3.8.1 Reducing Power Consumption .....	50
3.8.2 Configuring Power Saving Settings .....	50
3.8.3 Customizing the Power Setting.....	50
<b>Chapter 4: Network and Wireless Connections .....</b>	<b>52</b>
4.1 Connecting LAN.....	52
4.2 Disabling/Enabling Wireless Communication .....	52
4.2.1 Using Airplane Mode .....	53
4.2.2 Turning Wireless Communication On/Off Quickly .....	53
4.2.3 Turning On/Off the Airplane Mode.....	53

4.2.4 Using Network & Internet Settings .....	53
4.3 Connecting Wireless LAN .....	54
4.3.1 Using the WLAN.....	54
4.3.2 Using the WLAN by Hottab Utility .....	55
4.3.3 Enabling/Disabling WLAN Standard IEEE802.11a (802.11a) .....	55
4.4 Wireless WAN (4G/LTE) .....	55
4.4.1 Insert a SIM card.....	56
4.4.2 Connect/Disconnect to A Network .....	56
4.4.3 Using the Wireless WAN by Hottab Utility.....	57
4.5 BT Module .....	57
4.5.1 Turning On/Off the BT Function.....	58
4.5.2 Using the BT feature by Hottab Utility .....	58
4.5.3 Check BT Communication Status.....	59
4.6 GPS.....	59
<b>Chapter 5: Connectors.....</b>	<b>60</b>
5.1 External Display .....	60
5.2 USB Devices.....	61
5.3 COM Port Definition .....	61
<b>Chapter 6: Handling and Maintenance .....</b>	<b>64</b>
6.1 Operation environment .....	64
6.2 Handling Cautions.....	64
6.2.1 Handling the Screen.....	65
6.2.2 Using Peripheral Devices .....	65
6.2.3 When Battery Indicator Does Not Light On.....	65
6.3 Maintenance .....	66
6.3.1 Cleaning the LCD Panel .....	66
6.3.2 Cleaning Other Areas.....	66
6.4 Security Measures .....	66
6.4.1 Setting the Windows Password .....	66
6.4.2 Internet and Online Security .....	67
6.4.3 Other Security Measure.....	72
<b>Chapter 7: Basic Troubleshooting.....</b>	<b>74</b>
<b>Appendix .....</b>	<b>76</b>
Appendix A: Using Recovery Wizard to Restore Computer.....	76
Appendix B: Declaration of Conformity (DoC) .....	78
Appendix C: RoHS Statement.....	80
Appendix D: Upgrade and Warranty.....	80

# Preface

## Advisory Conventions

Four types of advisories are used throughout the user manual to provide helpful information or to alert you to the potential for hardware damage or personal injury. These are Notes, Important, Cautions, and Warnings. The following is an example of each type of advisory.

**Note:**

A note is used to emphasize helpful information

**Important:**

An important note indicates information that is important for you to know.



**Caution** A Caution alert indicates potential damage to hardware and explains how to avoid the potential problem.



**Warning!** An Electrical Shock Warning indicates the potential harm from electrical hazards and how to avoid the potential problem.



**Alternating Current!** The Protective Conductor Terminal (Earth Ground) symbol indicates the potential risk of serious electrical shock due to improper grounding.

## Safety Information



### General Product Safety *Sécurité générale des produits*

- Do not block any ventilation openings. Do not place the product against a wall or in an enclosed space as doing so might impede the flow of cooling air.
- *[FR] Ne pas bloquer les ouvertures de ventilation. Ne pas placer le produit contre un mur ou dans un espace clos de façon à entraver la circulation de l'air de refroidissement.*
- Do not place the product near any heat sources such as radiators, warm air intakes, stoves or other heat-generating devices (including amplifiers or other heat producing equipment).
- *[FR] Ne pas placer le produit près d'une source de chaleur comme des radiateurs, les arrivées d'air chaud, poêles ou autres produits générant de la chaleur (y compris les amplificateurs ou autre équipement produisant de la chaleur.)*
- Protect the power cord from being crushed or pinched, particularly in the area of the plugs, any receptacles used, and the point of exit from the apparatus. Do not break off the ground pin of the power cord.
- *[FR] Empêcher le cordon d'alimentation d'être écrasé ou pincé, en particulier dans les zones de prises, des containers utilisés, et du point de sortie de l'appareil. Ne pas casser la broche de terre du cordon d'alimentation.*
- Do not disregard the safety that a polarized or grounded connection can provide. A polarized connection consists of two plugs, one of which is larger than the other. A grounded connection has two blades and a third one that is grounded. If the main plug provided cannot be inserted into your outlet, consult an electrician to replace your obsolete outlet.
- *[FR] Ne pas ignorer la sécurité qu'une prise polarisée ou une prise de terre peut prévoir. Une prise polarisée se compose de deux fiches, dont l'une est plus large que l'autre. Une prise de terre possède deux lames et une troisième qui est la terre. Si la fiche principale fournie ne peut être insérée dans votre prise, consultez un électricien pour remplacer votre prise obsolète.*
- Use only accessories specified by the manufacturer.
- *[FR] Utiliser uniquement les accessoires spécifiés par le fabricant.*

- This product should not be used near water such as bathtubs, sinks, swimming pools, wet basement, etc.
- *[FR] Ce produit ne doit pas être utilisé près de l'eau comme les baignoires, les éviers, les piscines, les sous-sols humides, etc.*

- Use only with its transport carriage, stand, tripod, console or table specified by the manufacturer or sold with the product. When using a carriage, move the carriage assembly with the product carefully to avoid damage from falling over.
- *[FR] Utiliser uniquement avec son chariot de transport, support, trépied, console ou table spécifiés par le fabricant ou vendu avec le produit. Lors de l'utilisation d'un charriot, déplacez l'ensemble chariot avec le produit avec soin pour éviter tout dommage de chute.*

- Unplug this apparatus during lightning storms or when it is not being used for long periods.
- *[FR] Débrancher cet appareil durant les orages ou lorsqu'il n'est pas utilisé pendant de longues périodes.*

- Refer all servicing to qualified service personnel. A technical intervention is required when the apparatus has been damaged in any way, for example if the power cord or plug is damaged, liquid has been spilled or objects have fallen inside the unit, if the product has been exposed to rain or moisture, if it does not operate normally or if it has been dropped.
- *[FR] Confier toute réparation à du personnel qualifié. Une intervention technique est nécessaire lorsque l'appareil a été endommagé de quelque façon, par exemple si le cordon d'alimentation ou la fiche est endommagé, du liquide a été renversé ou des objets sont tombés à l'intérieur de l'unité, si le produit a été exposé à la pluie ou à l'humidité, s'il ne fonctionne pas normalement ou s'il a été jeté.*



### General Guideline *Directive générale*

It is recommended to reboot the device when some functions are defect or inactive. If it still can't solve the problems, please contact your dealer or agent.

*Il est recommandé de redémarrer l'appareil lorsque certaines fonctions sont défectueuses ou inactives. Si le problème persiste, veuillez contacter votre revendeur ou votre agent.*

## Handling and Maintenance



### General Guideline Guide Général

Keep the product at least 13 cm (5 inches) away from electrical appliances that can generate a strong magnetic field such as TV, refrigerator, motor, or a large audio speaker.

*[FR] Garder le produit au moins à 13 cm (5 pouces) de distance des appareils électriques qui peuvent générer un fort champ magnétique comme une télévision, un réfrigérateur, un moteur, ou un important haut-parleur.*

Do not place heavy objects on top of the computer as this may damage the display.

*[FR] Ne pas placer d'objets lourds sur le dessus de l'ordinateur cela peut endommager l'écran.*

The screen surface can be easily scratched. Use with care. Do not use paper towels to clean the display but use the included cleaning cloth. Avoid touching it with a pen or pencil.

*[FR] La surface de l'écran peut être facilement rayée. Utiliser avec précaution. Ne pas utiliser de serviette en papier pour nettoyer l'écran mais utiliser le chiffon de nettoyage inclus. Éviter de toucher avec un stylo ou un crayon.*

To maximize the life of the backlight in the display, allow backlight to automatically turn off as a result of power management. Avoid using a screen saver or other software that prevents the power management from working.

*[FR] Pour maximiser la durée de vie du rétroéclairage de l'écran, autoriser le rétroéclairage résultant de la gestion de l'alimentation. Éviter d'utiliser un économiseur d'écran ou un autre logiciel empêchant la gestion de l'alimentation de fonctionner.*



### Cleaning Guideline Guide de nettoyage

Use a soft cloth moistened with water or a non-alkaline detergent to wipe the exterior of the product.

*[FR] Utiliser un chiffon doux humidifié avec de l'eau ou un détergeant non alcalin pour essuyer l'extérieur du produit.*

Gently wipe the display with a soft, lint-free cloth. Do not use alcohol or detergent on the product.

*[FR] Essuyer délicatement l'écran avec un chiffon doux non pelucheux. Ne pas utiliser d'alcool ou un détergent sur le produit.*



### Touchscreen Guideline Guide de l'écran tactile

Use your finger or the stylus on the display. Using sharp or metallic object may cause scratches and damage the display, thereby causing errors.

*[FR] Utiliser votre doigt ou le stylet sur l'écran. L'utilisation d'un objet pointu ou métallique peut provoquer des rayures.*

Use a soft cloth to remove dirt on the display. The touchscreen surface has a special protective coating that prevents dirt from sticking to it. Not using a soft cloth may cause damage to the special protective coating on the touchscreen surface. To clean off hard to remove dirt, blow some steam on the particular area and gently wipe away using a soft cloth.

*[FR] Utiliser un chiffon doux pour enlever la poussière sur l'écran. La surface de l'écran tactile a un revêtement protecteur spécial empêchant la saleté de se coller à lui. Ne pas utiliser un chiffon doux peut endommager le revêtement spécial sur la surface de l'écran tactile. Pour nettoyer les saletés plus difficiles à enlever, souffler de la buée sur la zone particulière et essuyer doucement avec un chiffon doux.*

Do not use excessive force on the display. Avoid placing objects on top of the display as this may cause the glass to break.

*[FR] Ne pas utiliser une force excessive sur l'écran. Éviter de placer des objets au dessus de l'écran cela pourrait provoquer une cassure du verre.*

When there is a noticeable discrepancy in the operation of the touchscreen function (your touch does not correlate to the proper location on the screen), recalibrate the touchscreen display.

*[FR] Lorsqu'il y a un écart sensible dans le fonctionnement de l'écran tactile (votre contact ne correspond pas à la bonne position sur l'écran), recalibrer l'écran tactile.*

## Copyright Notice

No part of this document may be reproduced, copied, translated, or transmitted in any form or by any means, electronic or mechanical, for any purpose, without the prior written permission of the original manufacturer.

## Trademark Acknowledgement

Brand and product names are trademarks or registered trademarks of their respective owners.

## Disclaimer

Winmate Inc. reserve the right to make changes, without notice, to any product, including circuits and/or software described or contained in this manual in order to improve design and/or performance. We assume no responsibility or liability for the use of the described product(s) conveys no license or title under any patent, copyright, or masks work rights to these products, and make no representations or warranties that these products are free from patent, copyright, or mask work right infringement, unless otherwise specified. Applications that are described in this manual are for illustration purposes only. We make no representation or guarantee that such application will be suitable for the specified use without further testing or modification.

## About This User Manual

This User Manual provides information about using the Winmate L156 Series Rugged Laptop.

The documentation set includes:

- **L156 Rugged Laptop Quick Start Guide** - describes how to get the computer up and to run.
- **L156 Rugged Laptop User Manual** – contains a detailed description of how to use the device, its components, and features using the default setting.



**Note:**

Some pictures in this guide are samples and can differ from the actual product.



# Chapter 1: Getting Started

## 1.1 Overview

Congratulations on purchasing Winmate L156 Series Rugged Laptop.

Winnmate Rugged Laptop features with

- 13th generation Intel® Processor Family – Raptor Lake Processor
- 15.6" FHD Panel resolution with PCAP touch
- Dual battery with hot-swappable design for whole-day-work
- Anti-glare technology for sunlight readability
- Magnesium alloy enclosure with double injection for drop protection
- IP65 waterproof and dustproof

## 1.2 Package Content

Carefully remove the box and unpack your device. Please check if all the items listed below are inside your package. If any of these items are missing or damaged contact us immediately.

Factory shipment list:



- **Rugged Laptop**

Varies by product specifications



- **Quick Start Guide (Hardcopy)**

Part No. 91521110110P



- **Adapter**

Part No. 9220A230A059  
9220A17120P1 vary from sku



- **Power Cord**

Varies by country

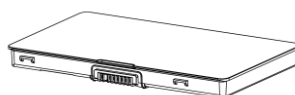

- **Standard Batteries x 2**

Part No. 32000000002L

## 1.3 Product Overview

This section contains mechanical drawing of the L156 Series Rugged Laptop. Notice that this is a simplified drawing and some components are not marked in detail.

### Right-side Components

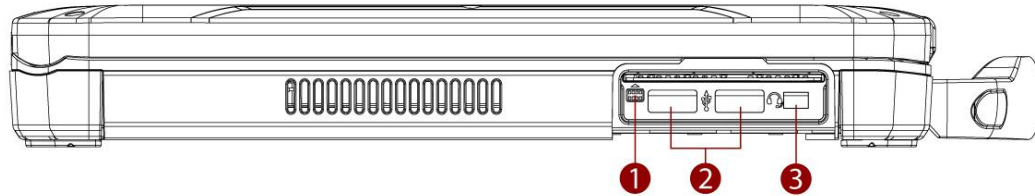

No	Item	Description
1	Smart Card Reader	To read and write data to a smart card
2	USB type-A	USB 3.0 port connects to USB devices, such as USB flash drive, mouse, keyboard, printer, etc.
3	Audio Jack	Connects a set of headphones or headset. (Mic is only supported with 3.5mm 4-pin headset).

### Left-side Components

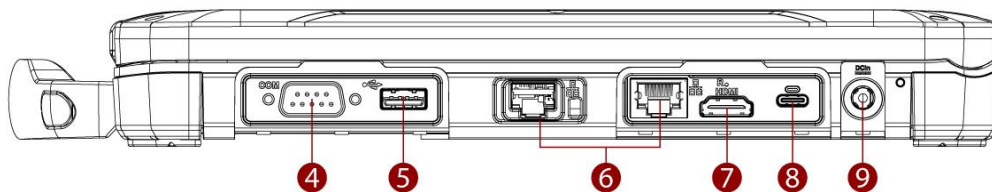

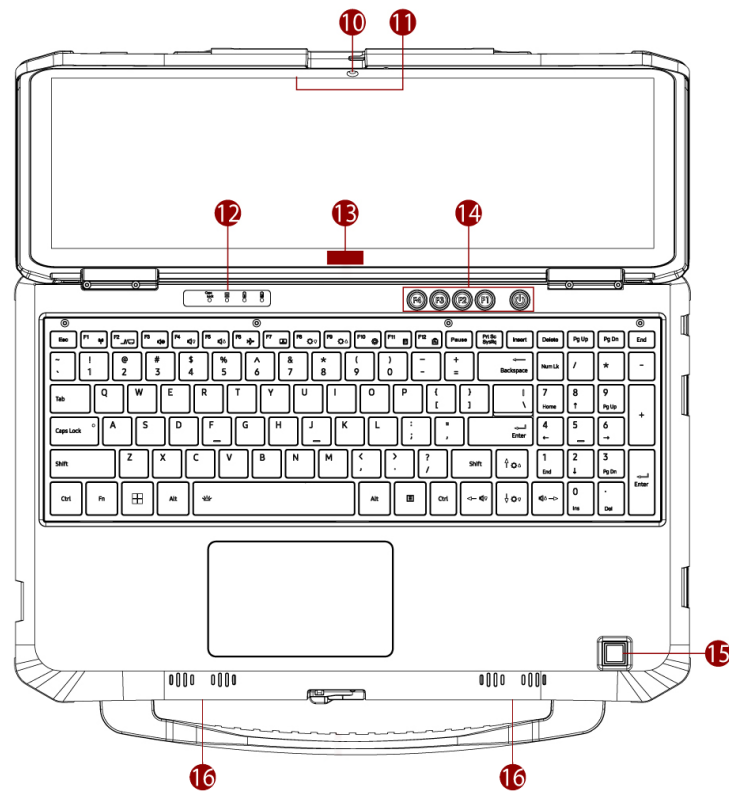

No	Item	Description
4	RS232/ RS422/ RS485	Interface that enables the connection of a serial device to a computer, software switchable.
5	USB Type-A	USB 3.0 port connects to USB devices, such as USB flash drive, mouse, keyboard, printer, etc.
6	RJ45	Connects the LAN cable.
7	HDMI	Connects a HDMI monitor or TV set.
8	USB type-C	High speed USB port connects to USB devices, such as USB flash drive, mouse, keyboard, printer, etc.
9	Power Jack	DC Power Input Jack

## Top-open Components



No	Item	Description
10	Front Camera	2 Megapixel Webcam.
11	Microphone	Enable audio recording for communications, music vocals, speech, and sound recording.
12	LED Indicators	Show the current status of the power, hard disc, and batteries.
13	HF RFID Reader (Optional)	Reads data from HF RFID tags.
14	Physical Buttons	4x Programmable function keys, and power button.
15	Fingerprint Scanner (Optional)	Serves as the fingerprint verification, preventing unauthorized access.
16	Speakers	Offer audio output

**LED Indicators**

Icon	Indicator	Description
	Power Indicator	<b>Blue</b> – Laptop is ON <b>No light</b> – Laptop is OFF
	Drive Indicator	<b>Green</b> - Disk is active <b>No light</b> - Disk is idling
	Battery Status	<b>Orange</b> - AC adapter is plugged in and charging <b>Green</b> - AC adapter is plugged in and the battery is fully charged <b>Solid Red</b> - Low battery (<10%) <b>Blinking Red</b> - Battery is hot-swapped. <b>No light</b> - Battery is in use, and more than 10%

**Bottom Components**

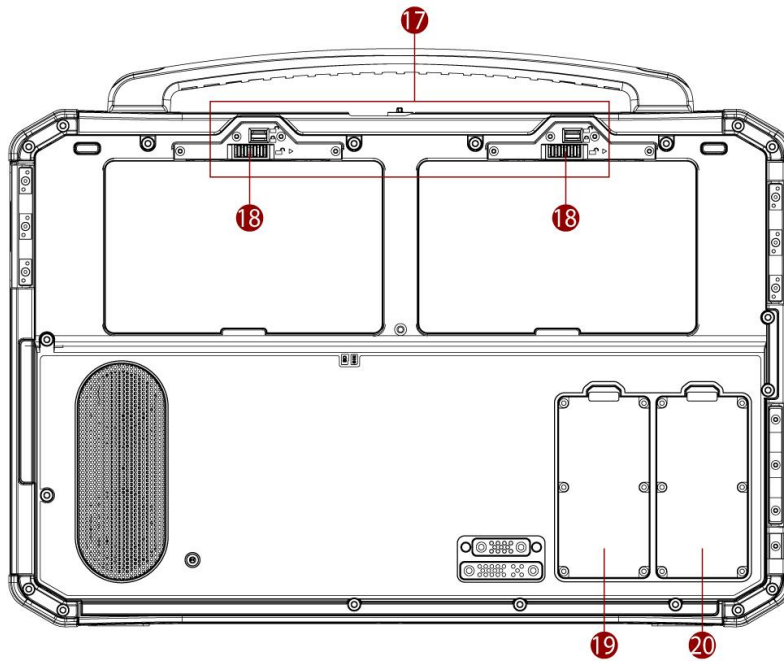

No	Item	Description
17	Battery Latch	To eject the battery, for replacing battery.
18	Battery Lock	To securely enable the battery.
19	RAM Slot	To allow RAM to be inserted into the device.
20	M.2 Slot for 2nd SSD	Contains the slot for the 2nd SSD. <b>CAUTION:</b> This device is not designed for hot-swapping. Do not remove it without turning off the system first.

## 1.4 Mechanical Dimension

Unit: mm

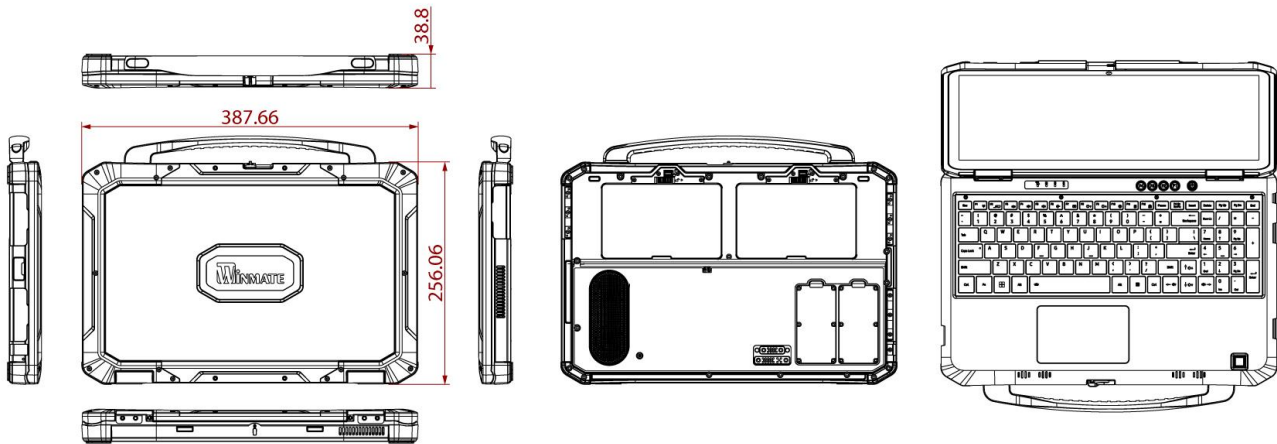

## 1.5 Hardware Installation

### 1.5.1 Installing a Micro SD Card

Your laptop supports up to 2TB additional storage with an optional microSD card slot.



#### **Important:**



- Do not remove or insert the microSD card until Windows has completed loading.
- Do not remove the card or turn off the computer in the following cases, otherwise the data may be corrupted.
  - While the computer is in sleep.
  - While data is being read from or written to the card.
  - Immediately after the writing operation, this computer may still continue to access to the card. If you remove the card before the operation is completed, the data may be damaged or the card access may no longer be performed normally.
- Note that Winmate assumes absolutely no liability for any loss of data recorded by the user, or any other damages, direct or indirect.
- Keep microSD cards away from infants and small children.

*To insert the Micro SD Card:*

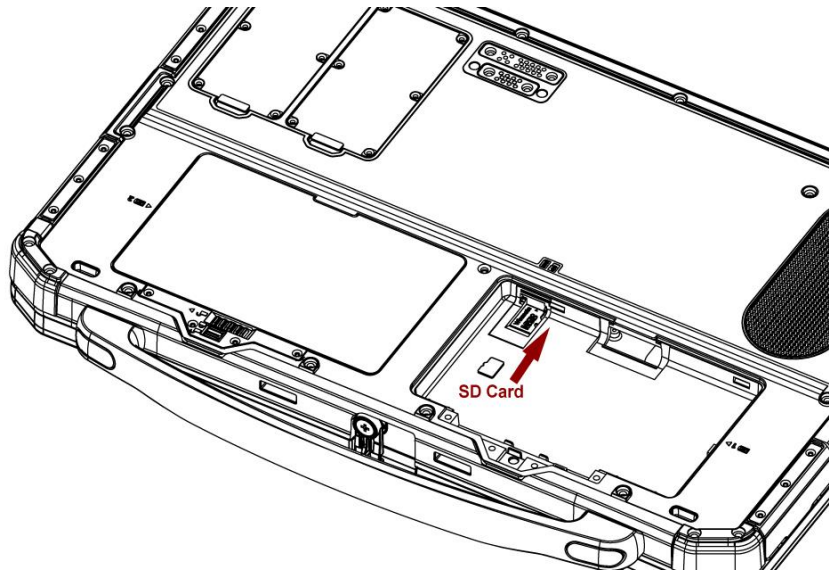
1. Remove the right battery, as described in section 1.6.1 *Installing and Removing the Battery*.
2. Insert microSD card into slot with contacts facing down.
3. Press the card in to ensure that it is seated properly.
4. Put the battery back.



*To remove Micro SD Card:*

1. Save the data and close all applications.
2. Disable the card: click  on the task tray, then click . Select the card.



**Note:**

This step is unnecessary when the computer is off, or,  is not displayed, or the card does not appear in the list.

3. Remove the right battery, as described in section 1.6.1 *Installing and Removing the Battery*.
4. Push and release the microSD card to unlock it.
5. Pull out the microSD card.
6. Put the battery back.

## 1.6 Battery

### 1.6.1 Installing and Removing the Batteries



#### Important:

- The battery pack is not charged when you first purchase it. Be sure to charge it before using for the first time. Charging starts automatically when the AC adaptor is connected to the computer.
- Use only the specified battery pack with your computer.
- If the computer is wet, wipe them off and open the cover. Make sure to dry off the computer, replace/remove the battery pack.
- Battery (Replaceable Type, lithium and other types): Lithium batteries or other types, if placed in operator access area, have the following markings (or the equivalent), either provided next to the batteries or in both operator and service manual. If the batteries are placed elsewhere, then the markings are either provided next to the batteries or in service manual.
- Caution risk of explosion if battery is replaced by an incorrect type. Dispose of used batteries according to the instructions.  
ATTENTION IL Y A RISQUE D'EXPLOSION SI LA BATTERIE EST REMPLACÉE PAR UNE BATTERIE DE TYPE INCORRECT.METTRE AU REBUT LES BATTERIES USAGÉES CONFORMÉMENT AUX INSTRUCTIONS

*To install the standard battery pack:*

1. Disconnect any cords connected to the computer.
2. Turn the laptop over, bottom part is facing up. Make sure no foreign objects are under the computer.
3. Locate the Battery Lock Latch and push it to the “Unlock” position.
4. Insert the battery with the connector-pins side first, and then lower the battery into the battery compartment.
5. Push completely until the battery locks into place.
6. Slide the battery latch to the lock position to secure the battery.
7. Repeat step 3 to 6 to insert the second battery.

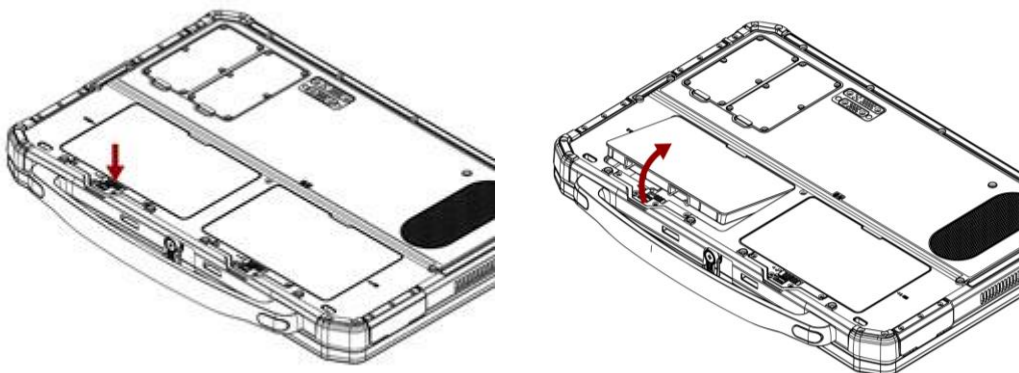

To remove the battery pack:



1. Shut down the laptop (or put into sleep mode). Disconnect any cords connected to the computer.
2. Turn the laptop over, bottom part is facing up. Make sure no foreign objects are under the computer.
3. Locate the Battery Lock Latch and push it to the “Unlock” position.
4. Locate the Battery Release Slider that is spring-loaded. Pull back and hold.
5. Lift the battery out using the opening on the side of the battery compartment.
6. Repeat step 3 to 5 to insert the second battery.



### Important:

- When hot-swapping the battery, check which battery needs to be replaced, then change it quickly.
- Make sure the latches are securely locked, otherwise the battery pack may fall when you carry the computer.
- Do not remove the battery pack forcibly when the latches are locked. Doing so may damage the battery pack.

## 1.6.2 Checking the Remaining Battery Power

Check the remaining battery power on the screen: Click  or  on the task tray. The remaining battery power is displayed.

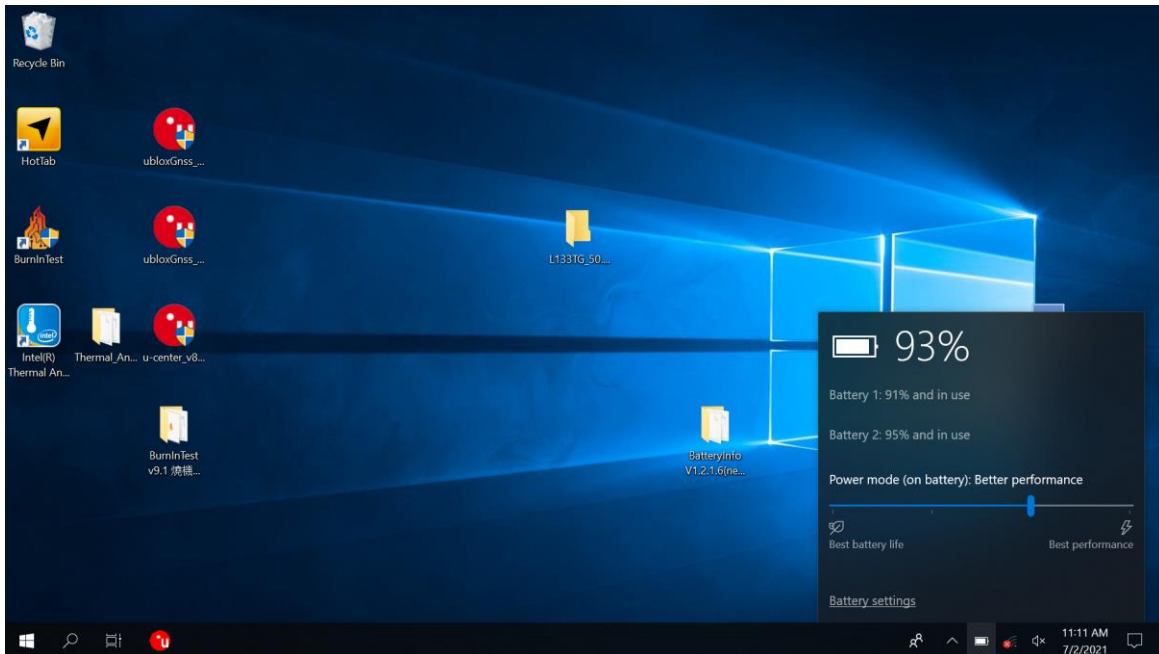

The default settings of computer with low battery:

Battery Status	Computer Behavior	Solutions
<10% Low Battery Level	Display a message that battery level is low	<p><b>Charge the battery or replace the battery:</b></p> <ul style="list-style-type: none"> <li>• Connect the AC adaptor immediately or exit the running programs and Windows. Then confirm that the power indicator is off.</li> <li>• If you have a fully charged spare battery, hot-swap one battery and turn the computer on again.</li> </ul>



<5% Critical Battery Level	Computer enters hibernation	<p><b>Connect the AC adaptor or replace the battery to start-up the computer:</b></p> <ul style="list-style-type: none"> <li>• Connect the AC adaptor and charge the battery.</li> <li>• If you have a fully charged spare battery, hot-swap one battery and turn the computer on again.</li> </ul> <p>When the computer enter hibernation with the battery down and you resume the operation without charging the battery, the Windows Resume Loader starts up. Follow the on-screen instructions. After that, however, Windows may not start up normally, or the Low battery Level/Critical battery level function may not work normally.</p>
----------------------------	-----------------------------	-------------------------------------------------------------------------------------------------------------------------------------------------------------------------------------------------------------------------------------------------------------------------------------------------------------------------------------------------------------------------------------------------------------------------------------------------------------------------------------------------------------------------------------------------------------------------------------------------------------------------------------------------

**Note:**

When about 5% battery will go to sleep and may displayed as “Not available” is not a malfunction. Please wait for a while to connect the AC adaptor.

### 1.6.3 Connecting to AC Power



**Caution** Use only the AC adaptor included with your computer. Using other AC adaptors may damage the computer.

You must use AC power when starting up the computer for the very first time.

1. Plug the AC power cord to the AC/DC adapter.
2. Connect the DC power connector into the laptop's power jack.
3. Plug the AC power adapter into a 100-240V power source.

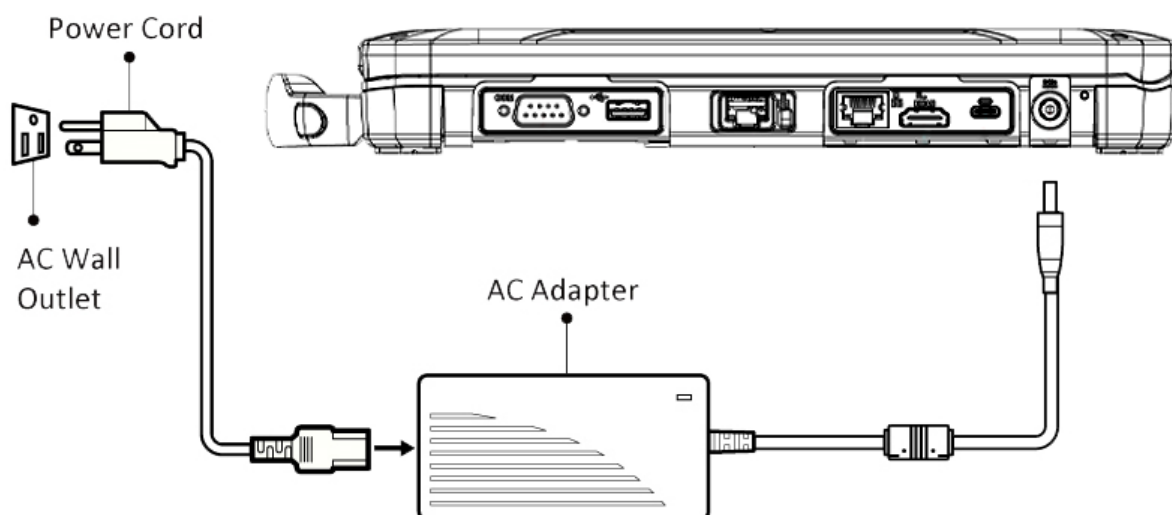

## **1.6.4 Important Battery Tips**

### ***1.6.4.1 How to Use Battery with Minimal Deterioration***

The battery performance is normally deteriorated over time. But the deterioration can be accelerated due to the battery is used, charged, or stored in a place with high temperature or repeatedly charged.

To reduce the deterioration and ensure longer battery life, you must reduce the number of charges and ensure that the temperature inside the battery does not become too high. If battery deteriorates, be sure to replace with a new and specified battery pack.

- Do not charge the battery inside a vehicle with all its windows closed and exposed to the hot sun or in other high temperature places. Charge the battery in a temperature range of 10 °C to 30 °C (50 °F to 86 °F).
- Recharge the battery no more than once a day or hot-swap the battery when one of the remaining charges drops to <10%.
- Charge the battery when the computer is powered off to keep the temperature inside the battery.

### ***1.6.4.2 Operating the Computer to Maximize the Battery Operation Time***

- Leave computer off when it is not in use
- Decrease the internal LCD brightness by pressing **Fn + ↓**.
- Before stepping away from your computer, enter the sleep or hibernation mode to reduce power consumption.
- Avoid the use of screen saver or applications that will drain the CPU.
- Remove peripheral devices (USB devices, external mouse, etc.) when not in use.
- When the network communication is not working, turn off the wireless LAN.

### ***1.6.4.3 When the Computer Is Inactive for a Long Period of Time***

To maintain the battery performance, when not used for a long period (several months or more), remove the battery with a remaining charge of 30% to 40% from the computer and store in a cool and dark place, within the range of 10 °C to 30 °C (50 °F to 86 °F).

### ***1.6.4.4 Notices While Using the Battery Pack***



- Do not touch the terminals on the battery pack. If the terminals are dirty or damaged, it will hinder the computer operation and battery performance.
- To charge the battery quicker, power the computer off or put it in sleep or hibernation mode.
- The battery discharges faster and charge longer in low temperature environments.

## 1.7 Turning On/Off

### 1.7.1 Turning On the Computer



**Note:**

- Do not press the power switch  repeatedly.
- The computer will forcibly be turned off if you press and hold the power switch for ten seconds or longer.
- Once you turn off the computer, wait for ten seconds or more before you turn on the computer again.
- Do not perform the following operation until the drive indicator  turns off.
  - Connecting or disconnecting the AC adaptor
  - Pressing the power switch
  - Touching the keyboard, touchpad, touchscreen or external mouse.
  - Closing the display.

1. Open the top cover by pushing the cover latch and lifting up the cover.

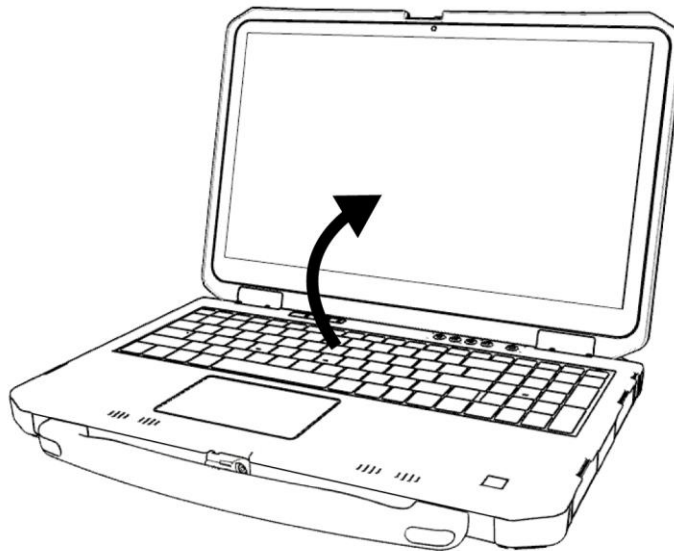



2. Press the power button  in the keyboard or physical buttons. The Windows operating system should start.

### 1.7.2 Sleep/Hibernation Functions

The sleep or hibernation functions can be used to shut off the computer without closing programs and documents and quickly using them.

### 1.7.2.1 Setting Sleep/Hibernation

#### Sleep



1. Right- click  or  on the task tray, and click **Power Options**.
2. Click **Change plan settings** of the power plan you want to change.
3. Select the setting for **Put the computer to sleep** and click **Save changes**.





#### Note:

The setting for hibernation may change unexpectedly when you change the setting for sleep.

#### Hibernation

1. Right- click  or  on the task tray, and click **Power Options**.
2. Click **Change plan settings** of the power plan you want to change.
3. Click **Change advanced power settings**.
4. Double-click **Sleep and Hibernate after**.
5. Click the item and select the setting.
6. Click **OK**.

Hibernation from the Windows system menu is not available as the factory default. To enter hibernation from the Windows system menu, the following setting is necessary.

1. Right- click  or  on the task tray, and click **Power Options**.
2. Click **Choose what the power buttons do** → **Change settings that are currently unavailable**.
3. Add check mark for **Hibernate**. Click **Save changes**.





#### Important:

- Connect the AC adaptor if the computer will be in sleep for a long period of time. Or use hibernation instead.
- Using sleep or hibernation repeatedly may cause malfunction of the computer. To stabilize computer operation, restart Windows regularly (about once a week),
- Save the necessary data.
- Close files you have opened from removable disks and network drives.
- Do not enter sleep or hibernation in the conditions below. It will cause data or file may be corrupted, malfunction of sleep and hibernation, computer, or the peripheral devices.
  - When the extended desktop function is activated.
  - When the drive indicator  is on and micro-SD card is installed.
  - When playing/recording audio files or displaying motion video
  - When playing or writing to a disc.
  - When using communication software or network functions.
  - When using peripheral devices.
- The password you set in the Setup Utility will be requested upon resuming from hibernation (not from sleep) or fast startup.
- It may take 1 or 2 minutes to enter hibernation. Do not touch any key though the screen becomes dark.

### 1.7.2.2 Entering Sleep/Hibernation

To put it in sleep/hibernation mode either by:

- Press the power button once, or
- Close the top cover, or
- Click  **Start** →  **Power** → **Sleep**.



#### **Important:**

- While computer is entering sleep, do not:
  - Touch the keyboard, touchpad, touchscreen, or power switch.
  - Use an external mouse or other peripheral devices.
  - Connect or disconnect the AC adaptor.
  - Close or open the display
  - Insert and remove the MicroSD Card or SIM Card.
- It may take 1 or 2 minutes to enter sleep. Do not touch any key though the screen becomes dark.
- After releasing the power switch, do not operate it until the power indicator blinks or goes off. If you press and hold the power switch for longer than 4 seconds, the computer will forcibly shut down and might result to loss of the unsaved data.
- Do not attach or remove peripheral devices. Doing so may cause malfunction.
- Power is consumed in sleep. When power is exhausted, the data retained in memory will be lost. Connect the AC adaptor when the computer is in the sleep function for a prolonged time.

### 1.7.2.3 Resume from Sleep/Hibernation

To resume from sleep, either:

- Open the display, press the power switch , or
- Touch the keyboard or touchpad to resume.



#### **Important:**

- Do not perform the following operations until resuming is complete. After the display is resumed, wait approximately 15 seconds (normally) or 60 seconds (when the computer is on a network).
  - Touch the keyboard, touchpad, touchscreen, or power switch.
  - Use an external mouse or other peripheral devices.
  - Connect or disconnect the AC adaptor.
  - Close or open the display.
  - Shut down, or sleep/hibernation, or restart Windows.
  - Insert and remove the MicroSD Card or SIM Card.
- If the computer enters sleep while a USB keyboard or mouse is connected, touching the USB keyboard keys or mouse may resume the computer.

### 1.7.3 Turning Off the Rugged Laptop



#### **Important:**

- Do not perform the following operations
  - Touch the keyboard, touchpad, touchscreen, or external mouse.
  - Pressing power switch.
  - Connect or disconnect the AC adaptor.
  - Close the display

You can shut down your laptop by Click  **Start** →  **Power** → **Shut down**.

To turn off the laptop completely, follows:

1. Click  **Start** → **Setting** → **Update & Security** → **Recovery**.
2. Click **Restart Now**.
3. Click **Turn off your PC**.



#### **Note:**

- Save your files before performing this option to prevent loss of important data.
- To conserve power, the following power saving methods are set at the time of purchase.
  - The screen automatically turns off after:
    - 10 minutes (when AC adaptor is connected) of inactivity
    - 4 minutes (when on battery power) of inactivity
  - The computer automatically enters sleep after:
    - 10 minutes (when AC adaptor is connected) of inactivity
    - 4 minutes (when on battery power) of inactivity

# Chapter 2: Operating Your Rugged Laptop

## 2.1 Using the Keyboard

Your keyboard has all the standard functions of a full-sized computer keyboard plus a **Fn** button added for specific functions.

The standard functions of the keyboard can be further divided into four major categories:

- Typewriter keys
- Cursor-control keys
- Numeric keys
- Function keys



### Note:

- Do not repeatedly press the keys in quick succession.
- Do not use the key combinations together with touchpad (external mouse), touchscreen or other key operations.
- Do not use the key combinations before you sign in to Windows. Wait until the drive indicator  turns off.
- The key combinations may not work with some applications

### 2.1.1 Typewriter Keys

Typewriter keys are similar to the keys on a typewriter. Several keys are added such as the **Ctrl**, **Alt**, and **Esc** for special purposes.

The Control (**Ctrl**) and Alternate (**Alt**) keys are usually used in combination with other keys for program-specific functions. The Escape (**Esc**) key is commonly used for stopping a process, exit a program, and cancel a command. The function depends on the program you are using.

## 2.1.2 Cursor-Control Keys

Cursor-control keys are generally used for moving and editing purposes.

## 2.1.3 Numeric Keypad

Numeric keys facilitate entering of numbers and calculations.

## 2.1.4 Function Keys

Function keys are multi-purpose keys that perform functions defined by individual programs. Located on the top row of the keys are the function keys: **F1** to **F12**.









## 2.1.5 Fn Key

The **Fn** key, at the lower left corner of the keyboard, is used with another key to perform the alternative function of a key. Use by press and hold **Fn**, then press the other key.

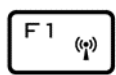

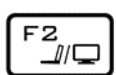

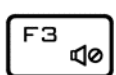



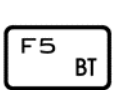

## 2.1.6 Hot Keys

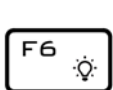
Hot keys refer to a combination of keys that can be pressed any time to activate special functions of the computer. Most hot keys operate in a cyclic way. Each time a hot key combination is pressed, it shifts the corresponding function to the other or next choice.

You can easily identify the hot keys with the icons imprinted on the keytop. The hot keys are described next.

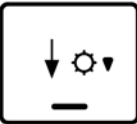
Key	Description
 	Close the currently used program window.
 	Switches the Airplane mode radio on and off. When off, all wireless modules (such as WLAN, BT, and WWAN) cannot be used. When on, individual settings of the module work.
 	Switch the display output options to the next choice if an external display is connected. Choices are: PC screen only, Duplicate, Extend, or Second screen only.  The hot keys are equivalent to  <b>Windows logo key + P</b> .
 	Switches the system sound output off (mute) or on.
 	Turn on/off camera

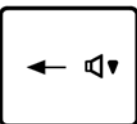

Key	Description
 	Turn on/off BT function.
 	Change keyboard backlight brightness (off, low, medium, maximum)
 	Increases the LCD brightness.
 	Decreases the LCD brightness.
 	Decreases the sound volume.
 	Increases the sound volume.

### 2.1.7 Windows Keys

The keyboard has a  Windows Logo key to perform Windows-specific functions.

The  Windows Logo key opens the **Start** menu and performs software-specific functions when used in combination with other keys.

## 2.1.8 Keyboard Backlight Settings

The  HotTab Utility Keyboard LED Settings can be used to choose color of the keyboard backlight.

1. Click  **HotTab Utility** → **Setting** → **Keyboard LED**.

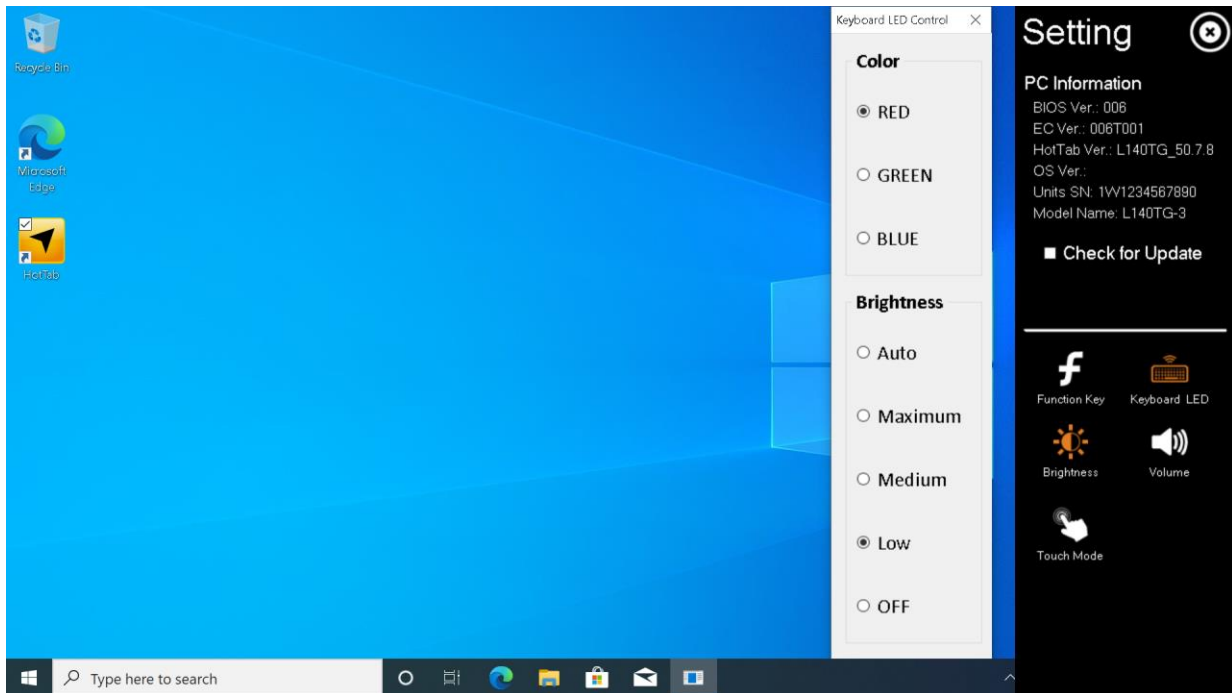

2. Select the color of the backlit keyboard and brightness level.

### Note:



- Change the brightness level using **Fn + F6** Hotkeys.
- Keyboard LED Brightness Auto setting is defined by panel's brightness.

*Turn on/off backlight keyboard:*

1. Launch the  HotTab Utility application.
2. Tap on the **Devices ON/OFF** button.
3. Check the status color of the Keyboard Backlight icon:

Item	Status Color	Description
 <b>Keyboard Backlight</b>	Orange	Keyboard Backlight is enabled.
	White	Keyboard Backlight is disabled.

4. If the keyboard backlight feature is disabled (white), tap on keyboard backlight icon to enable it (orange).

## 2.2 Using the Touchpad

The touchpad is a pointing device use to control the location of the pointer on the screen and making selection with the buttons.

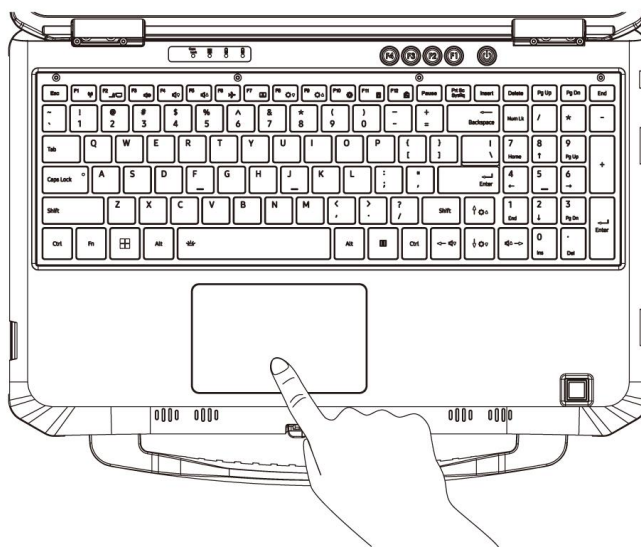

The touchpad consists of a rectangular pad (work surface) that acts like a miniature duplicate of the display. To use the touchpad, place your forefinger or thumb on the pad. As you slide your fingertip across the pad, the pointer (also called cursor) on the screen moves accordingly. When your finger reaches the edge of the pad, simply relocate yourself by lifting the finger and placing it on the other side of the pad.

Some common terms when using the touchpad:

Term	Action
<b>Point</b>	Move the finger on the pad until the cursor points to the selection on the screen.
<b>Click</b>	Tap gently anywhere on the pad.
<b>Double-click</b>	Tap twice on the pad rapidly.
<b>Drag and drop</b>	Gently tap twice on the pad and on the second tap, keep your finger in contact with the pad. Then, move your finger across the pad to drag the selected object to your destination. When you lift your finger from the pad, the selected object will drop into place.

### 2.2.1 Touch Gestures

The touchpad supports touch gesture such as two-finger scrolling, pinch zoom, rotating, and others. To configure the touchpad to suit the user's needs, go to  **Start** → **Settings** → **Devices** → **Touchpad**.

## 2.2.2 Disabling/Enabling the Touchpad

You can check the status of the touchpad on the  HotTab Utility application.

1. Launch the  HotTab Utility application.
2. Tap on the **Devices ON/OFF** button.
3. Check the status color of the Touchpad icon:

Item	Status Color	Description
 <b>Touchpad</b>	Orange	Touchpad is enabled.
	White	Touchpad is disabled.

4. If the touchpad feature is disabled (white), tap on touchpad icon to enable it (orange).



### **Note:**

- When the touchpad is disabled, it will remain disabled until you enable it again, even if the computer restarts.
- This function cannot be used with this unit even if you perform the following operations:
  1. Click  **Start** → **Settings** → **Devices** → **Touchpad**.
  2. Add the check mark to **Press the lower right corner of the touchpad to right-click**.

## 2.2.3 Changing the Cursor Speed of Touchpad

You can change the cursor speed of touchpad by these procedures:

1. Click  **Start** → **Settings** → **Devices** → **Touchpad**.
2. Slide the bar of **Change the cursor speed**. Moving the slider to the left will change the cursor speed to be slow.

## 2.2.4 Handling the Touchpad



By design, the touchpad is to be used with a fingertip only. Do not place any object on the work surface or press down forcefully with sharp-pointed objects (e.g., nails) or hard objects that can leave marks (e.g., pencils and ball point pens). Try to avoid having any harmful substances, such as oil, come in touchpad. The cursor may not work properly in such cases.

When the touchpad become dirty: wipe to remove dirt by using a dry soft cloth such as gauze or a thoroughly wrung soft cloth with diluted detergent and water. Do not use benzene or thinner, or rubbing alcohol. Doing so may adversely affect the surface, e.g., discoloration. In addition, do not use commercially available household cleaners and cosmetics, as they may contain components harmful to the surface.

## 2.3 Using the Touchscreen

### 2.3.1 Changing Touchscreen Modes

The computer supports three built-in operating modes for different usage scenarios:

Mode	Description
 <p><b>Hand/Rain (Default)</b></p>	<p>In <i>Hand/Rain</i> mode the touchscreen rejects false inputs from liquid drops. When the liquid is removed, the touchscreen accepts touch inputs from bare fingertips.</p> <p>Supports input by:</p> <ul style="list-style-type: none"> <li>• <i>Rubber tip passive stylus</i></li> <li>• <i>Bare fingertips</i></li> </ul>
 <p><b>Stylus</b></p>	<p>In <i>Stylus</i> mode, the touchscreen supports inputs from the fine-tip passive capacitive stylus.</p> <p>Support input by:</p> <ul style="list-style-type: none"> <li>• <i>Fine-tip passive stylus with palm rejection</i></li> <li>• <i>Rubber tip passive stylus</i></li> <li>• <i>Bare fingertips</i></li> </ul>
 <p><b>Glove</b></p>	<p>In <i>Glove</i> mode, the touchscreen supports inputs while the user is operating the touchscreen with gloves on.</p> <p>Supports input by:</p> <ul style="list-style-type: none"> <li>• <i>Glove</i></li> <li>• <i>Rubber tip passive stylus</i></li> <li>• <i>Bare fingertips</i></li> </ul>

To change touch mode: Launch  **HotTab Utility** → **Setting** → **Touch Mode**.



#### **Important:**

Do not touch the screen while switching the operation mode. It will cause operation failure.

## 2.3.2 Touch Gestures

Hand gestures on touch screen panel allow you to launch programs and access the settings to operate the Rugged Laptop. Some of the touchscreen gestures:

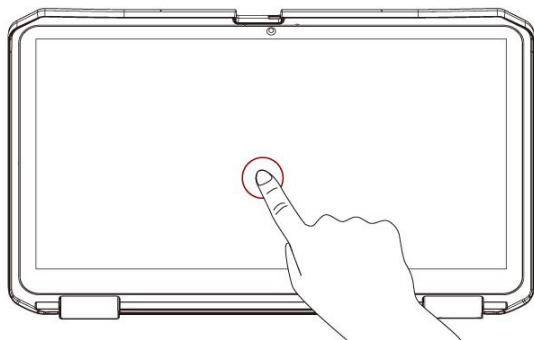

**Tap**  
To select an item.

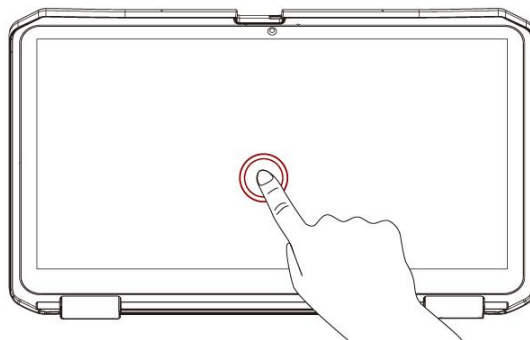

**Double tap**  
To launch program and select a block of text.

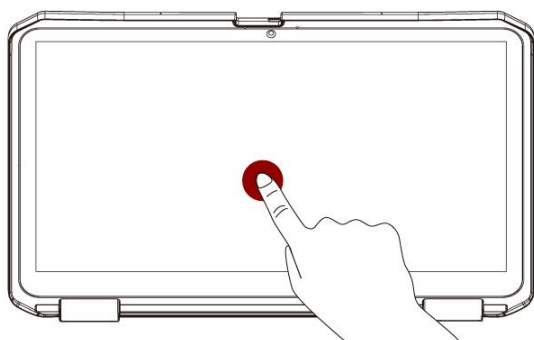

**Tap and hold**  
Tap and hold an item until a menu appears  
(if available).

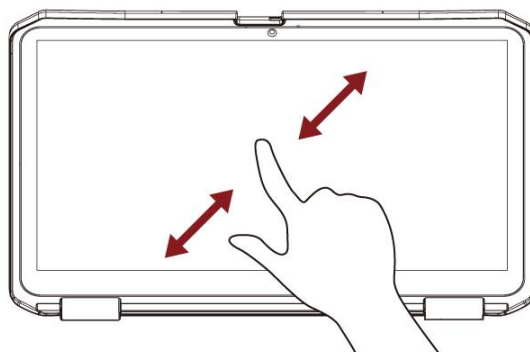

**Pinch or stretch**  
Use two of fingertips to zoom out or zoom in.

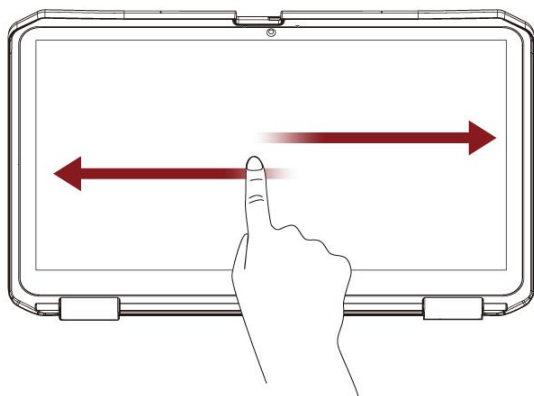

**Slide to the right or left**  
To go backward or forward through the web  
browsing history.

## 2.4 Using Physical Button



Physical Button	Description
F1	User-programmable function key. Default setting : none
F2	User-programmable function key. Default setting : none
F3	User-programmable function key. Default setting : none
F4	User-programmable function key. Default setting : none
Power	Press once to turn on. Quick press to quit the operating system. Long press around 8 seconds for force shut down.

To change F1 ~ F4 buttons behavior: Launch HotTab Utility → Setting → Function Key.

## 2.5 Turn On/Off LED Indicator

You can check the status of the indicator on the HotTab Utility application.

1. Launch the HotTab Utility application.
2. Tap on the **Devices ON/OFF** button.
3. Check the status color of the indicator icon:

Item	Status Color	Description
 Indicators	Orange	Indicator is enabled.
	White	Indicator is disabled.

4. If the indicator feature is disabled (white), tap on indicator icon to enable it (orange).

## 2.6 Using Smart Card Reader

The Smart Card Reader is an optional feature of L156 Series Rugged Laptop and is designed to allow ICC (Chip) card transactions from your computer. Support ISO 7816 Part 1, 2, 3, T=1 and T=0 protocol IC card, EMV Level 1 Compliant.

To use this feature, please make sure your laptop has built-in smart card reader before use, or contact our sales department for more details.

To read ICC card insert the card into the smart card reader(optional) located on the left side.

## **2.6.1 Inserting/Removing the Smart Card**

*To insert the card:* Insert the Smart Card with the contact part in reverse side until it surely fits in the slot.

*To remove the card:* Draw the card straight out using your finger.



### **Important:**

Do not:

- Hit, bend, or drop the card.
- Touch the contact part with finger or metal object.
- Place the card in very hot location for a long time.
- Remove the card immediately after inserting it.



## Chapter 3: Configuring the Rugged Laptop

### 3.1 BIOS Utility

The BIOS utility is a hardware configuration program built into your computer's BIOS. Your computer is already properly configured and optimized, and you do not normally need to run this utility. However, if you encounter configuration problems, you may need to run it.

To activate the BIOS utility, press **DEL** while the computer logo is being displayed.

#### 3.1.1 Boot sequence

To set the boot sequence in the BIOS utility:

1. Activate the BIOS utility.
2. Select **Boot** from the categories listed on the left of the screen.

#### 3.1.2 Setting passwords

1. Activate the BIOS utility.
2. Select **Security** from the categories listed on the left of the screen.
3. Find **Set Supervisor Password** and enter a password to enable this feature.
4. Choose to enable/disable **Password on Boot**.
5. Select F10 to properly save and exit the BIOS utility when you are done making changes.

### 3.2 Setting Up Windows 10 IoT Enterprise

The L156 Series Rugged Laptop operates on Windows 10 IoT Enterprise operating system.



**Caution** Make sure the battery is full charged before starting the Rugged Laptop for the first time with internal battery power.

- **Public network:** Select this location if you do not recognize all the computers on the network. (For example, you are in a coffee shop or airport, or you have mobile broadband.) This is a public network and is *not* trusted. Select the location where you will most often use the computer.

Follow the steps below to complete the Windows 10 IoT Enterprise setup process.

1. Press the power button to turn on the computer.
2. First, select your country/region, your preferred app language, your preferred keyboard layout, and your time zone, then tap Next.

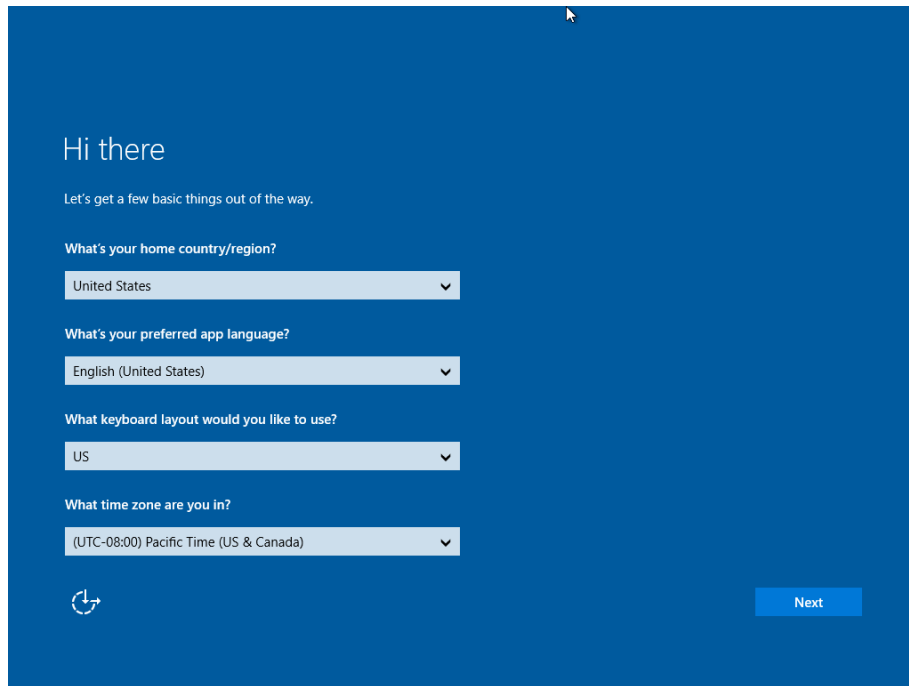

3. On the **Here's the legal stuff** screen, read through the disclosures, then tap **Accept**.

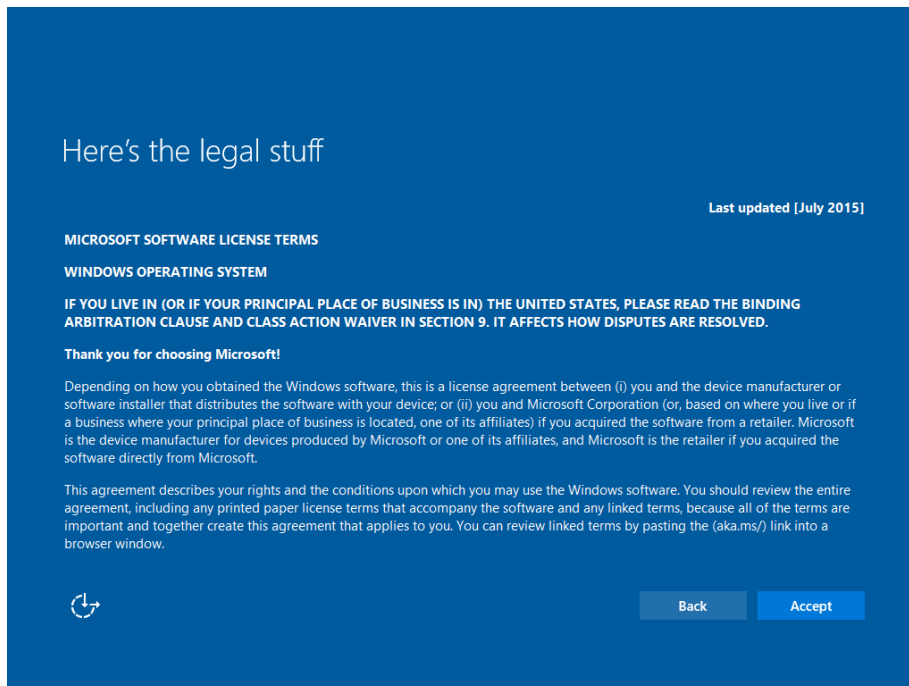

4. Windows will then try to connect to network. Tap **Skip this step** to continue without a wireless connection as you can then set up the network later.

5. On the **Get going fast** screen, click **Use Express settings** for the fastest setup. If you would like more information, tap **Learn more**, or if you would like to select your own options, click **Customize settings**.

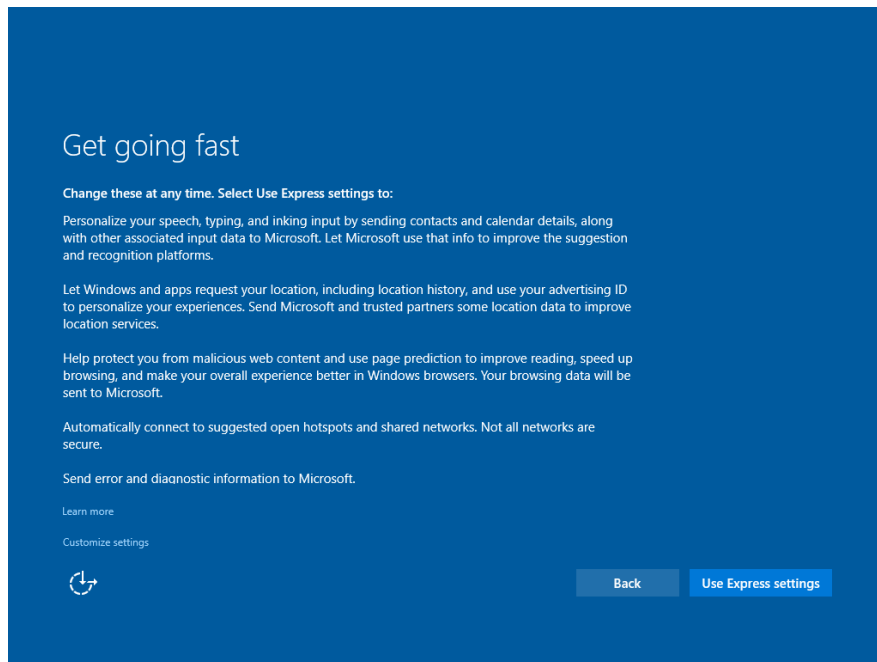

6. To create a local account, type your User name, password, and Password hint in the fields provided, then tap **Next**.

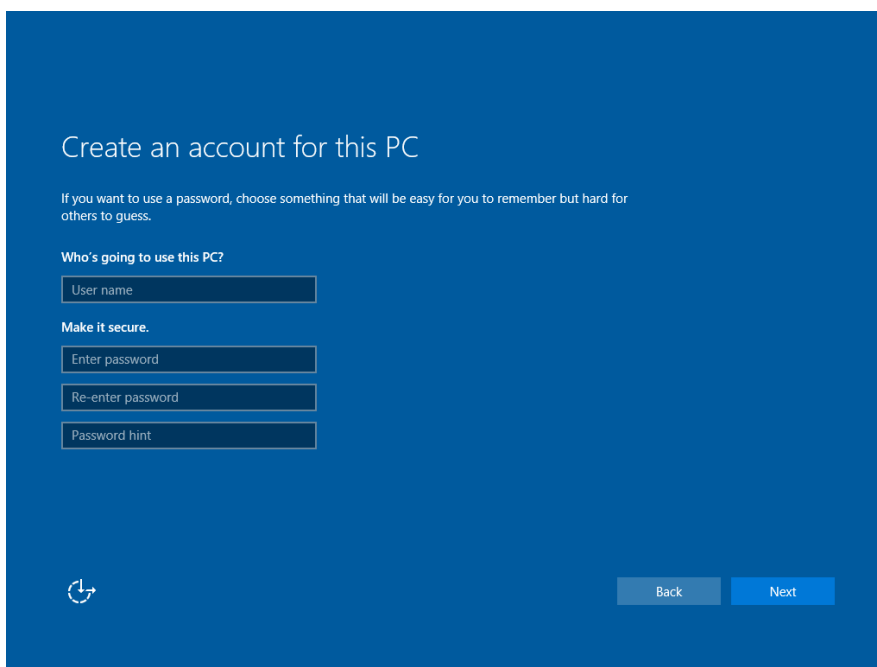

7. The initial setup screens are complete, and the desktop is displayed.
8. Read any introductory screens describing features of your computer, and tap **Next** upon completing each. You are now done with the initial setup process.

### 3.3 Hottab Introduction

Hottab provides quick access to the laptop's functions and features, such as setting up shortcuts, using camera, powering on/off built-in devices, programming function key, etc.

As Windows starts up, Hottab starts and runs in the background. To display the Hottab control

utility, launch the Hottab Utility application by clicking the **Hottab Utility Icon**:



The main user interface is located on the right side of the screen. There are 2 main menu options: **Device ON/OFF** and **Setting**.

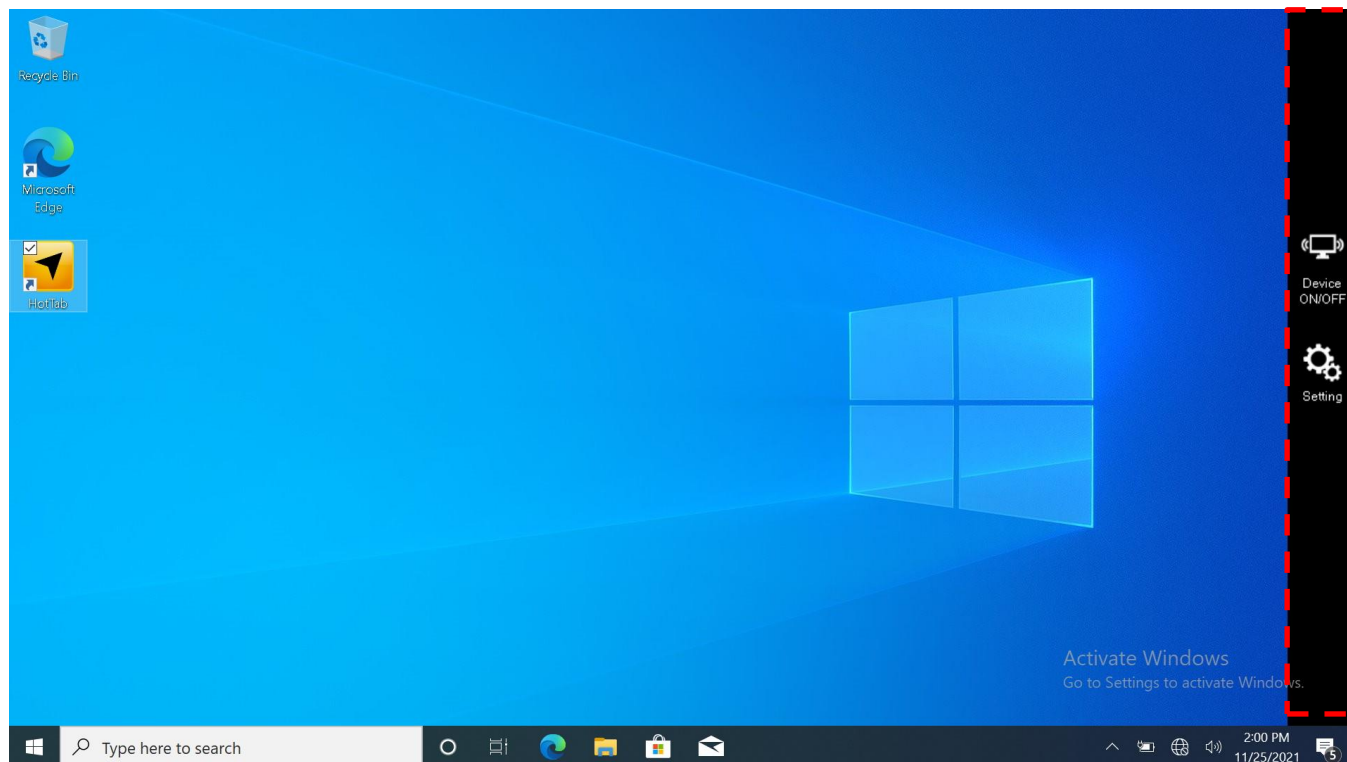

Device ON/OFF features the enables and disables functions of camera, touch, touchpad, indicators, keyboard backlight, fingerprint scanner<sup>1</sup>, HF RFID<sup>1</sup>, WLAN, WWAN, GPS, BT, and external antennas<sup>2</sup>.

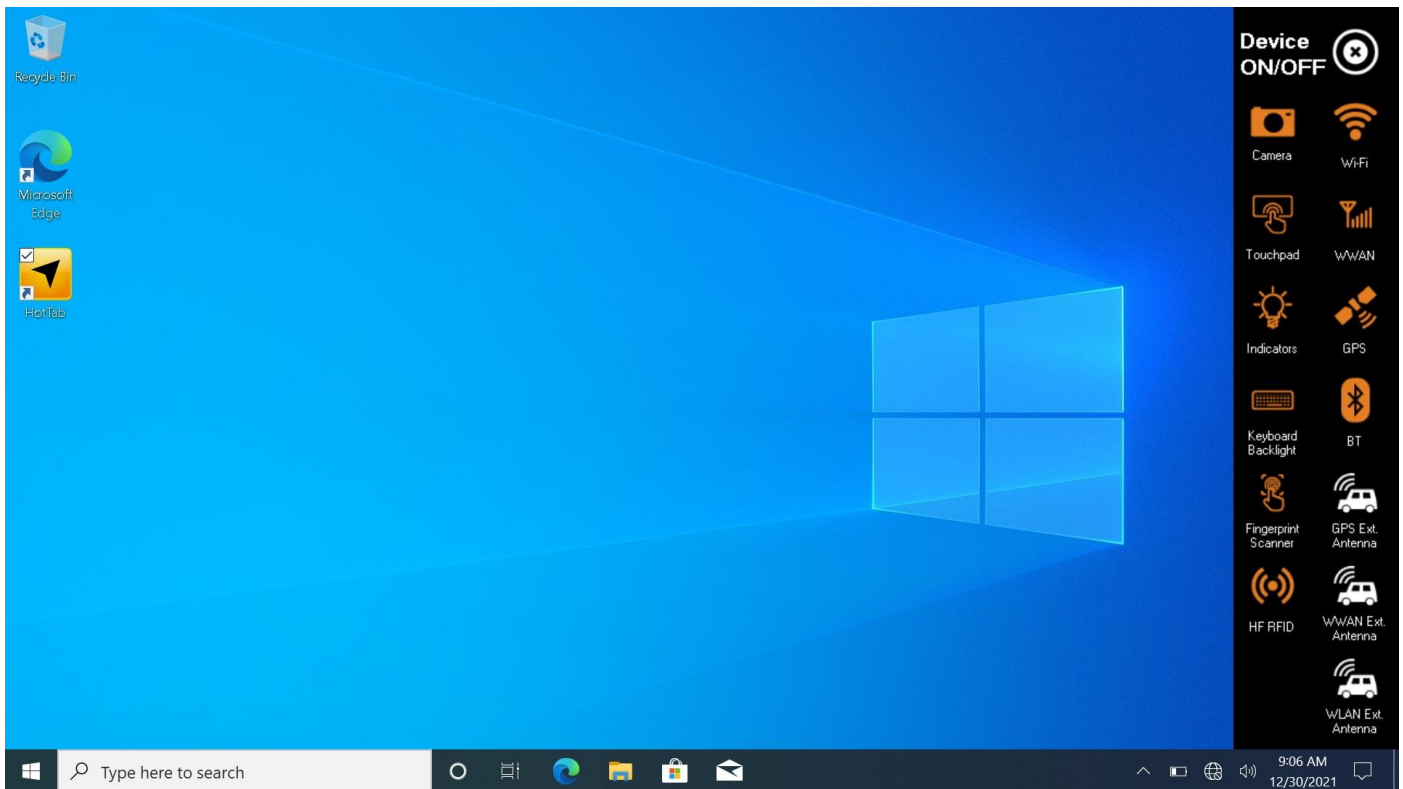

Setting is use to set up function key, touch mode, keyboard LED color, panel brightness, and volume.

<sup>1</sup> Only for model with the feature.

<sup>2</sup> Only available if laptop is connected to docking.

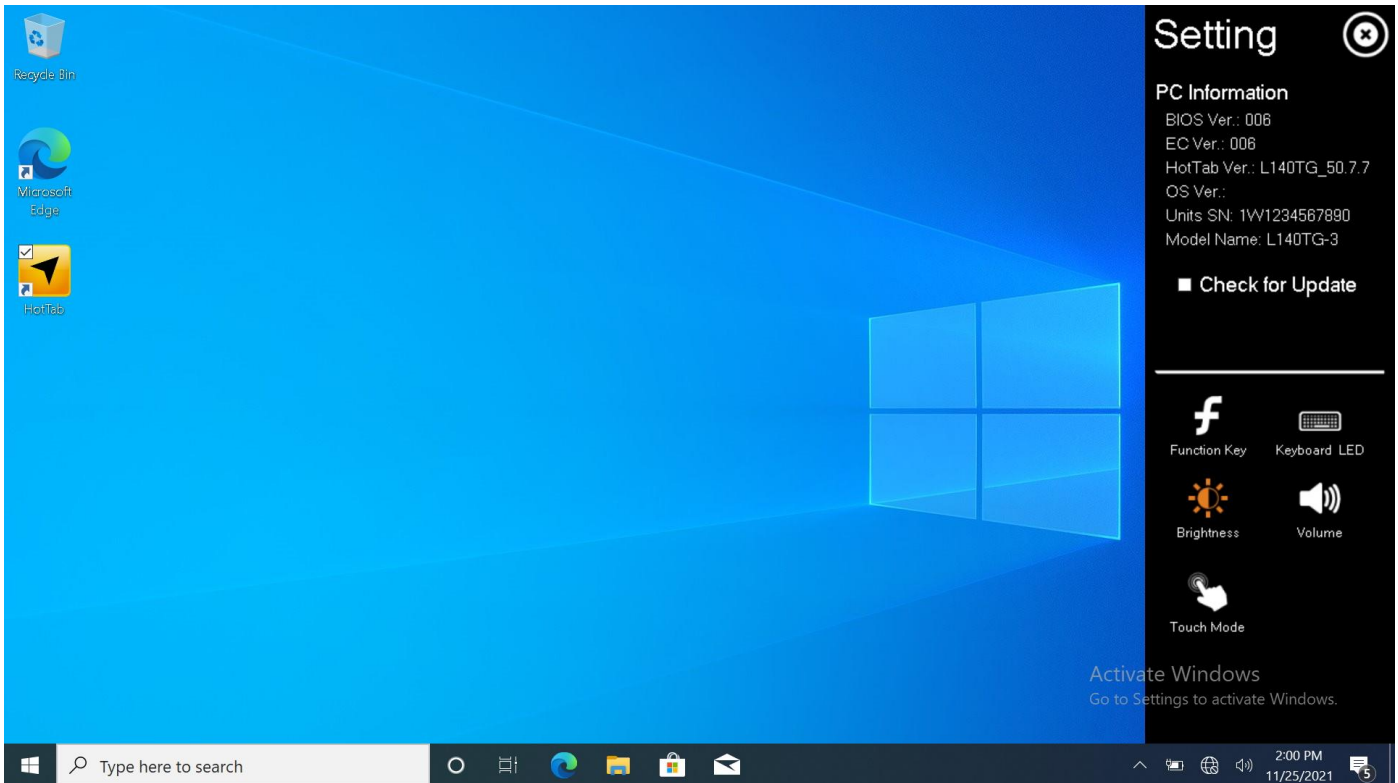

## 3.4 Hottab Utility Setting

This Hottab menu provides users information such as PC Information, Battery Information, Check for Update, and also device settings such as power management setting, and function key mappings. Perform the following procedure to access the Hottab Setting menu:

1. Launch the Hottab Utility application.
2. Below are the items listed in Setting menu.

### 3.4.1 PC Information

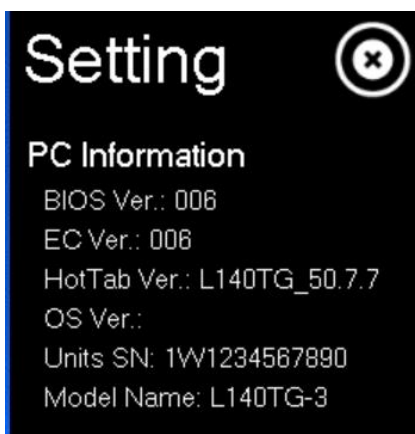

This section provides user device information in regards to BIOS Version, EC Versions, Hottab Versions, OS Versions, as well as Unit Serial Number, shown in the picture sample.

### 3.4.2 Check for Update

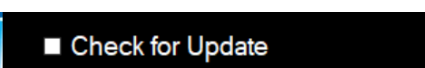

Click to check for update

### 3.4.3 Function Keys

Hottab Shortcuts Menu provides a user-friendly interface to configure function keys short cuts and allow users to quickly access programs with a press. The Function menu offers 4 empty slots to store user's desired quick access. Shortcuts can be mapped to any of the executable files (.exe) installed on the laptop.

#### Function Key Menu:

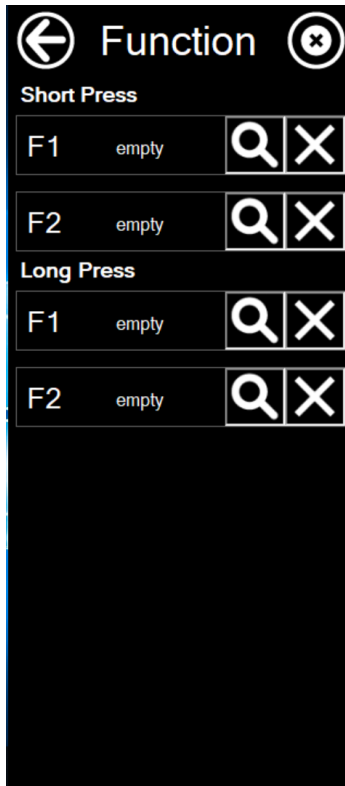

#### To store a new shortcut:

1. Launch the **Hottab Utility** application → **Setting**.
2. Tap on the **Function Key**.
3. Tap on button of any empty slot.
4. An on-screen file browser will appear.
5. Browse to find the desired application to have shortcut.
6. Click “Open” to save the shortcut.

#### To remove a saved shortcut:

1. Launch the **Hottab Utility** application → **Setting**.
2. Tap on the **Function Key**.
3. Tap on the button of any saved slot to remove
4. Shortcut will be removed, and once again show “Empty” to indicate slot is empty.

Tap on the button will hide the Hottab Utility Menu.

#### Using the Hottab shortcuts:

1. Launch the **Hottab Utility** application → **Setting**.
2. Tap on the **Function Key**.
3. Tap on the saved shortcut items to access saved programs.

### 3.4.4 Touch Mode

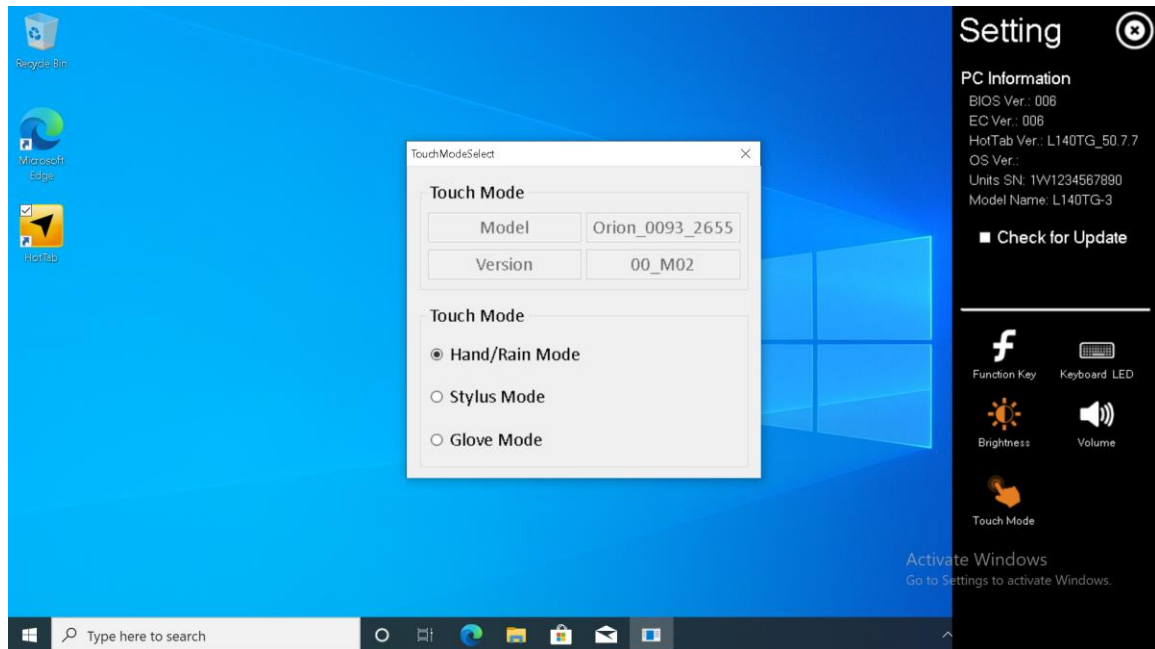

The computer supports three built-in operating modes for different usage scenarios:

- Hand/Rain Mode,
- Stylus Mode, and
- Glove Mode.

### 3.4.5 Keyboard LED

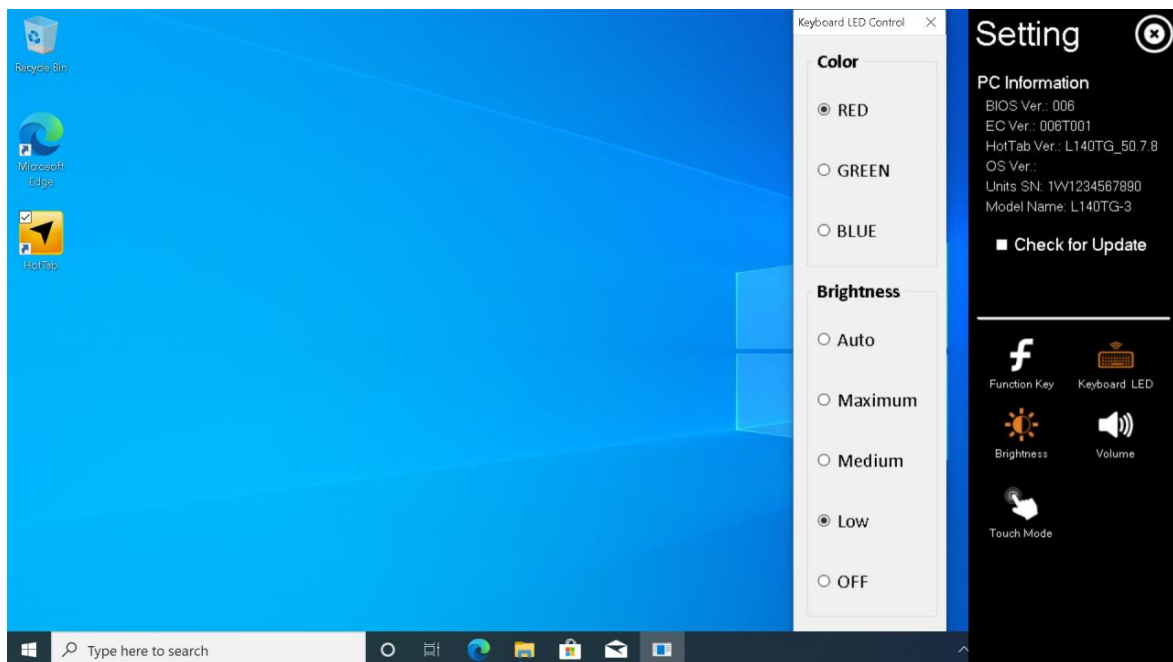

The computer supports seven colors for keyboard LED color: red, green, and blue.

Keyboard LED brightness can be set either: auto/ maximum/ medium/ low/ off. The auto setting will synchronize keyboard LED with panel brightness. Pressing **Fn + F6** will change the keyboard backlit brightness: off/ low/ medium/ maximum.



### 3.4.6 Brightness

This section allows user to change the panel brightness manually. Slide the bar to the left side to reduce the brightness, or to the right to increase it.

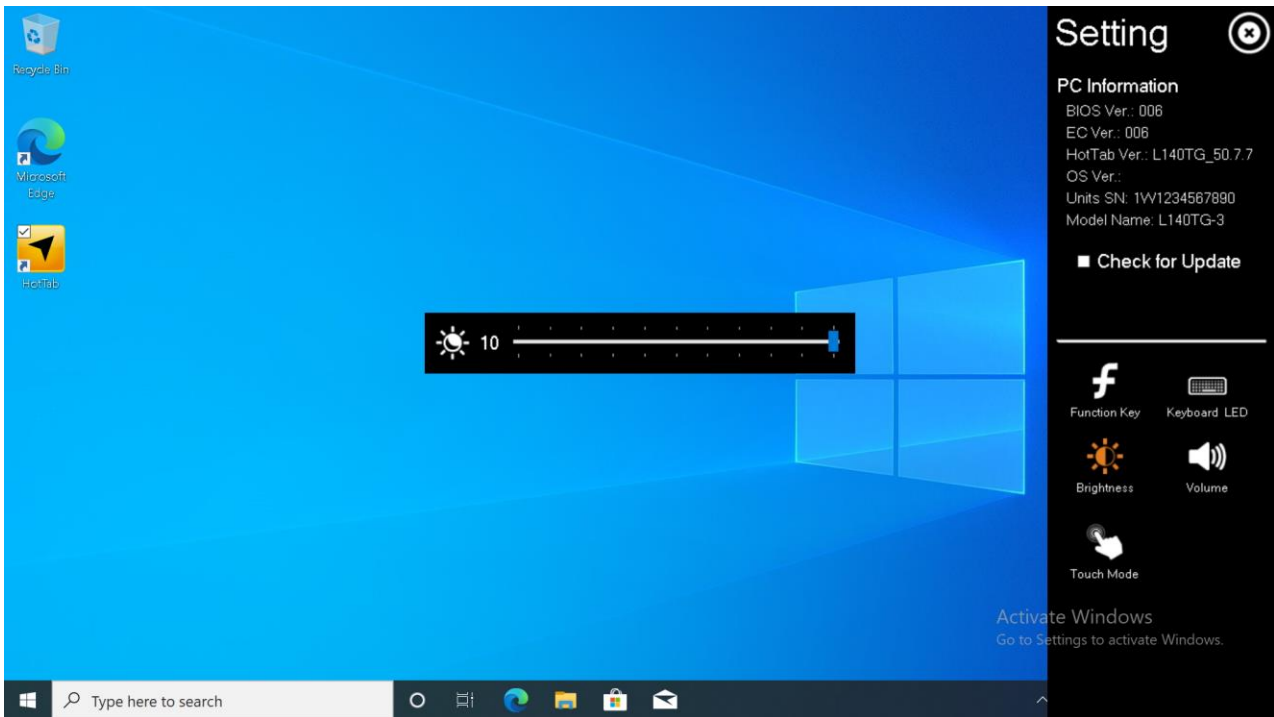

### 3.4.7 Volume

This feature allows user to change the device speaker's volume. Slide the bar to the left side to reduce the volume or to the right to increase it.

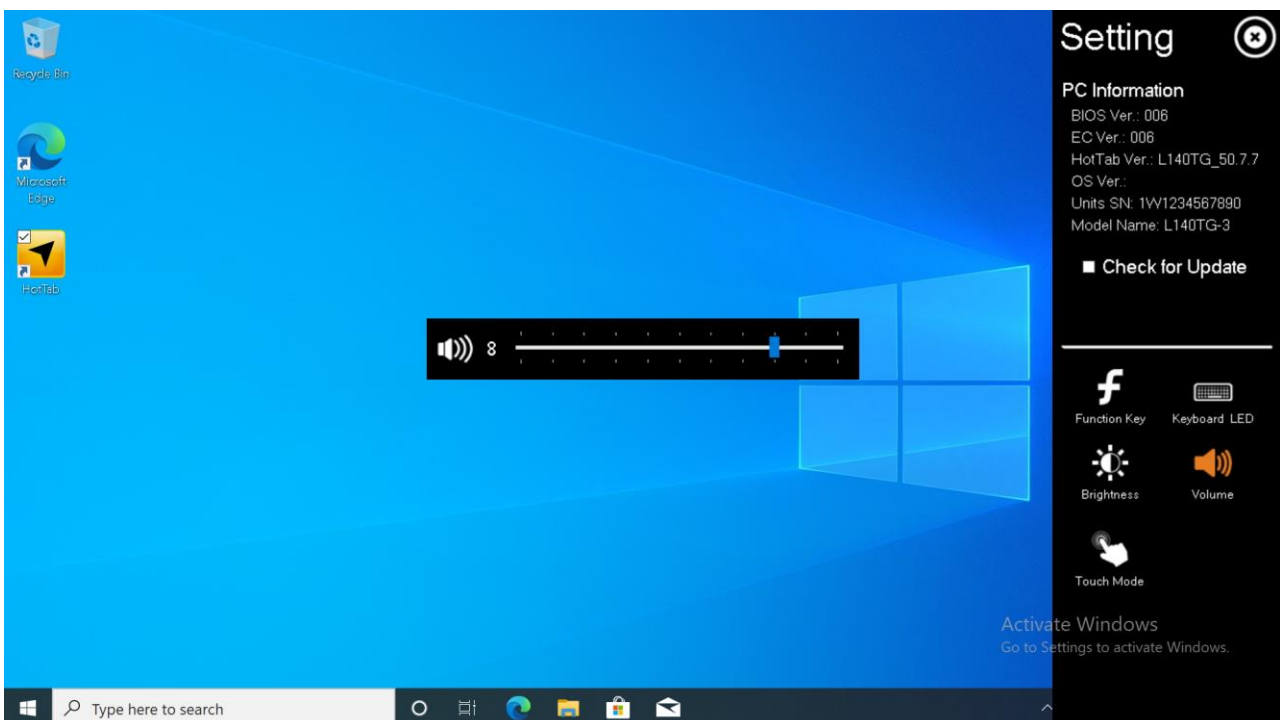

## 3.5 Using Camera

The rear camera is optional.

### 3.5.1 Enable Camera Interface with Hottab Utility

1. Launch the  Hottab Utility application.
2. Tap on **Device ON/OFF** button to check the status of the built-in device.
3. Check the status color of the **Camera** icon:

Item	Status Color	Description
 <b>Camera</b>	Orange	The camera is enabled.
	White	The camera is disabled.

4. If the camera is disabled (white), tap on the *Camera* icon to enable it (orange).





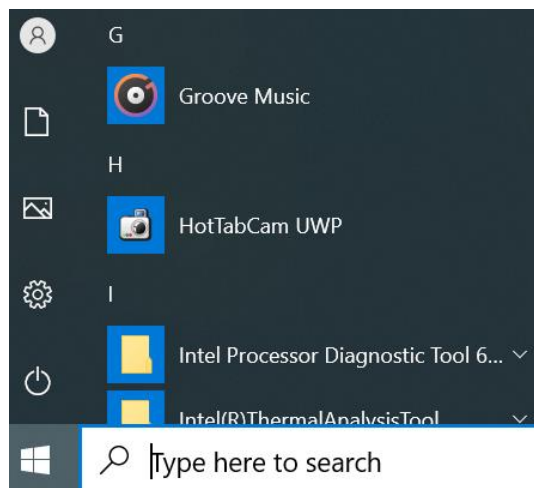

### 3.5.2 Open Camera Interface

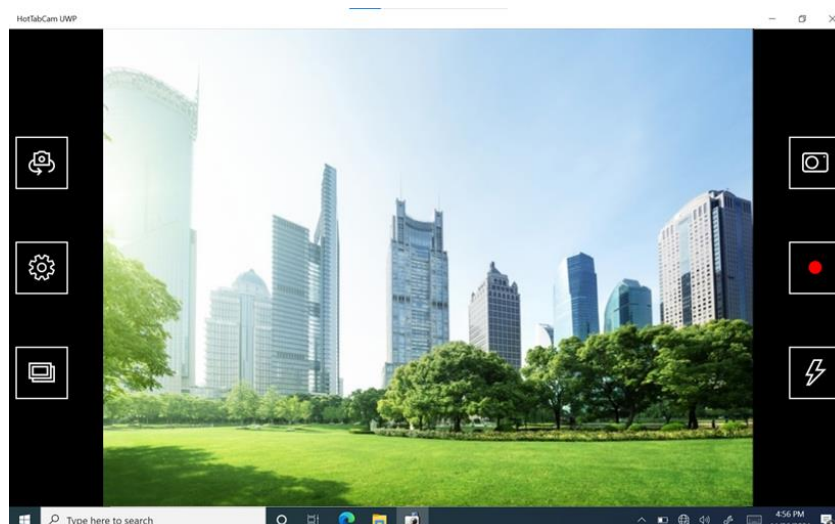
1. Click  **Start** → **HotTabCam UWP**.



2. The default camera is the front camera. To change into the optional rear camera, click on the **Switch Camera** button.



No	Item		Description
1	Switch Camera		Switch between front camera or rear camera.
2	Settings		Opens Camera settings page. Available Settings: <ul style="list-style-type: none"> <li>• <b>Picture Save:</b> modify/inspect saved location for pictures.</li> <li>• <b>Video Save Folder:</b> modify/inspect saved location for video recordings.</li> <li>• <b>Picture Quality:</b> Picture compression quality.</li> </ul>
3	Review		Review
4	Shutter Camera		Camera Shutter Button. Tap to take picture.
5	Video Record		Tap to Start, and press again to stop recording.
6	Flash Control		Enables/ Disables LED Flash when taking picture.

## 3.6 Using Fingerprint Scanner

<Only for model with fingerprint scanner>

### 3.6.1 Precaution

*For security when using fingerprint authentication:*

- Fingerprint authentication does not guarantee complete user authentication and identification. Please note that we cannot accept liability for any loss or damage incurred from your use or inability to use fingerprint authentication. Please be forewarned.
- We cannot accept liability for any loss of data due to malfunction of the fingerprint reader.
- Registration may be impossible if there is insufficient fingerprint or other information to identify an individual.

*Fingerprint reader handling:*

- Avoid the following. Failure to do so may result in malfunction or damage to the fingerprint reader.
  - Do not rub or scratch the reader with hard materials or poke it with small pointed objects.
  - Do not touch the surface with dirty fingers.
  - Do not soil or cover the reader with a sticker.

- In the following cases, fingerprint reader sensitivity may be degraded, impeding or preventing authentication and registration.
  - If the surface of the fingerprint reader is soiled with dirt, skin oil, or sweat.
  - If the surface of the fingerprint reader is wet by moisture or condensation.
  - If your finger is too wet or too dry.
  - If your finger is wounded or inflamed.
  - If your fingerprint grooves have become too shallow due to wear.
  - If you touch the fingerprint reader while sliding your finger.
  - If you touch the fingerprint reader with a finger at an angle
  - If the pressing force to touch the fingerprint reader is weak.
  - If your finger is swollen, such as from bathing.
  - If your fingerprint has changed due to weight loss or gain.
- Fingerprint reader sensitivity may be restored by the following.
  - Wipe the fingerprint reader with a soft cloth.
  - Wash and wipe your hands.
  - Use another finger for registration and authentication.
  - If your finger is extremely dry, moisten it using hand cream.
- Static electricity can cause the fingerprint reader malfunction. To discharge static electricity, touch a metal surface before touching the fingerprint reader. Be especially careful about static electricity in the winter and other dry conditions.
- When a faulty fingerprint reader is repaired, previously saved passwords may be reset in the process. Please be forewarned.

#### *Setting a password:*

If you forget the sign in password, you will be unable to use the device or Windows, so be absolutely certain that you will not forget it.

### 3.6.2 Using Fingerprint Scanner with Hottab Utility

To use the fingerprint scanner feature to connect to the network, perform the following procedure:

1. Launch the  HotTab Utility application.
2. Tap on the **Devices ON/OFF** button.
3. Check the status color of the fingerprint icon:

Item	Status Color	Description
 <b>Fingerprint Scanner</b>	Orange	Fingerprint scanner is enabled.
	White	Fingerprint scanner is disabled.

4. If the fingerprint scanner feature is disabled (white), tap on the fingerprint scanner icon to enable it (orange).

### 3.6.3 Fingerprint Authentication Function

Use fingerprint authentication to improve security and convenience by replacing the conventional password entry required to sign in to Windows.

*To enroll a fingerprint:*

1. Click  **Start** → **Settings** → **Accounts** → **Sign-in options**.
2. On the right side under **Fingerprint**, click **Set up**.
3. Enter fingerprints by repeatedly touching and releasing your finger on the fingerprint reader.
4. Follow the on-screen instructions
5. To register more fingers, click **Add another finger** and repeat the same procedure.
6. Click **Set up PIN**.
7. Enter your account password, and click **OK**.
8. Enter your PIN number in **New Pin**.
9. Enter your PIN number again in **Confirm PIN** and click **OK**.



**Note:**

Register at least two fingers. That way, if by any chance one finger is injured, another can be used.

## 3.7 HF RFID

<Only for model with RFID reader>



### NOTE:

- Wave cards one at a time. If multiple cards are waved simultaneously, proper reading will not be possible.
- If the chip device is held outside of the contactless smart card reader area or at an angle, or waved incorrectly, proper reading may not be possible.
- Operation distance depends on RFID tag/ Smart card

To enable the HF RFID Reader feature:

1. Launch the Hottab Utility application.
2. Tap on the **Device ON/OFF** button.
3. Tap on **HF RFID**, and the setting utility will show up as below:

4. Tap on the **ON** button.
5. Check the status color of the ON icon is green, and the status color of the RFID icon on the Hottab menu is orange at the same time.

Item	Status Color	Description
 <b>RFID</b>	Orange	HF RFID Reader is enabled.
	White	HF RFID Reader is disabled.

**3.7.1 RFID Trigger Setting**

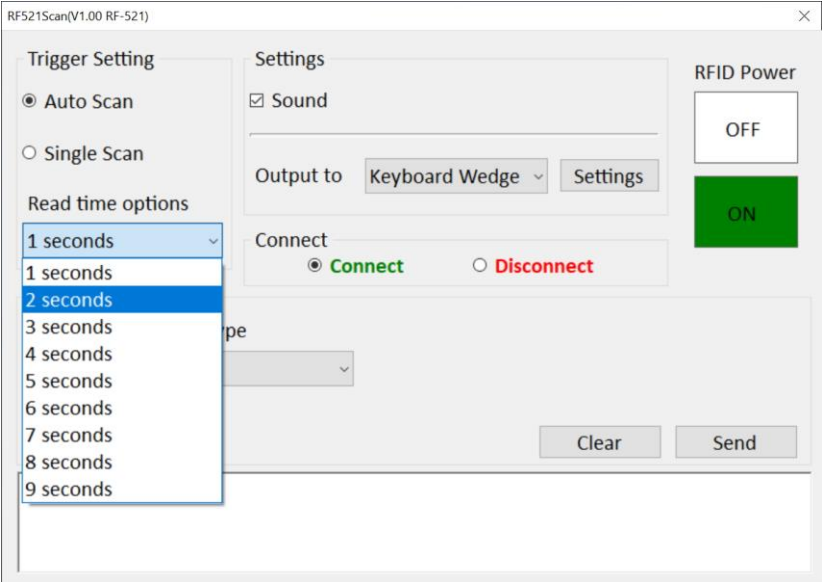
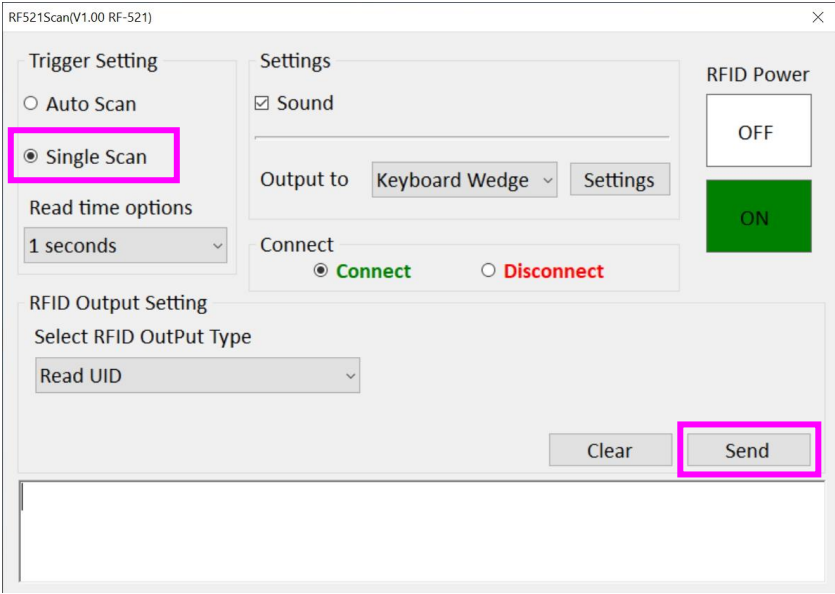
Item	Description
<p>Auto Scan</p>	<p>The default setting for RFID trigger is Auto Scan. Under this setting, the RFID Reader will always be ready to scan tags.</p> <ol style="list-style-type: none"> <li>1. When the RFID tag is detected from RFID antenna, the data will be read automatically.</li> <li>2. User can define the RFID scanning frequency from the drop-down menu shown as below. The frequency can be from 1 second to 9 seconds.</li> </ol> 
<p>Single Scan</p>	<p>User can also define the RFID Reader scanning as <b>Single Scan</b>. Under this setting, the RFID Reader will be triggered only when user click on “Send”.</p> 

### 3.7.2 Settings

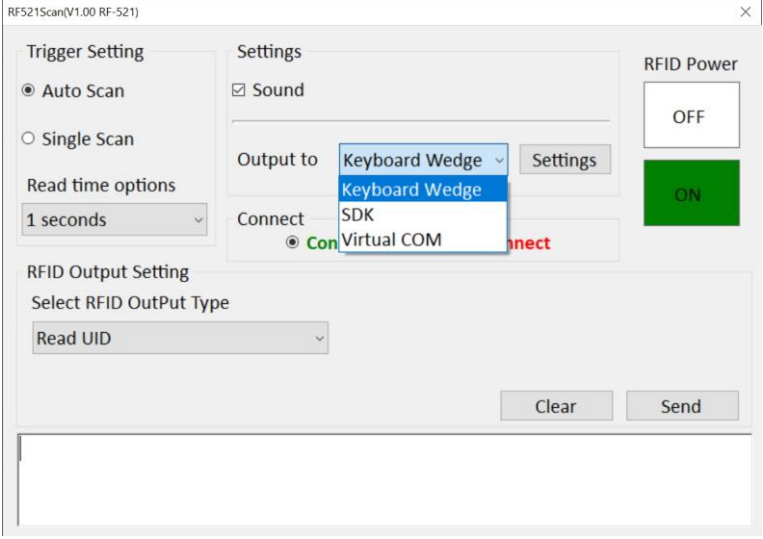
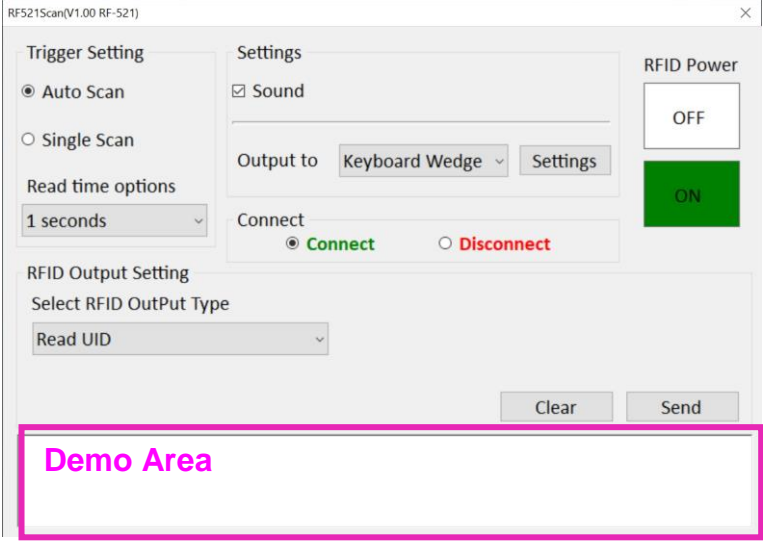
Item	Description
Sound	The <b>Sound</b> check box defines whether a beep sound will come with the data scanning.
Output to	<p>This setting defines the output type of the scanned data. Two options are available:</p>  <p><b>Keyboard Wedge</b></p> <p>Under this setting, the data scanned is sent like keyboard data. The scanned data can be output directly to the demo area below this window, or user can also open other utility, such as Office Word or Notepad files, for data input.</p>  <p><b>Demo Area</b></p> <p><b>Note:</b> notice that the input method should support the scanned character. User can also tap on the <b>Settings</b> button for further details settings.</p>



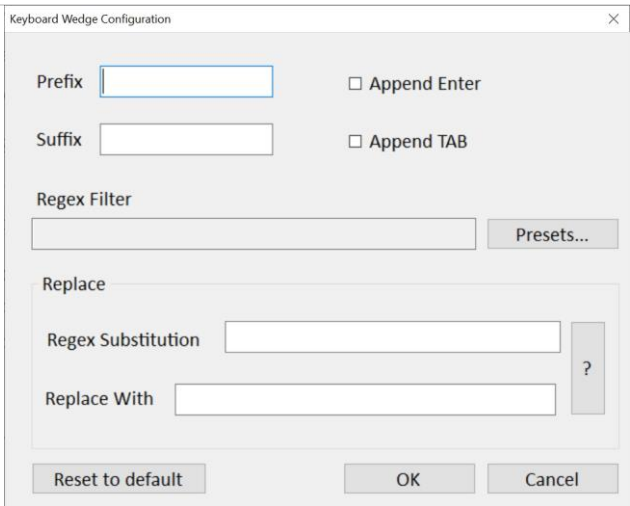

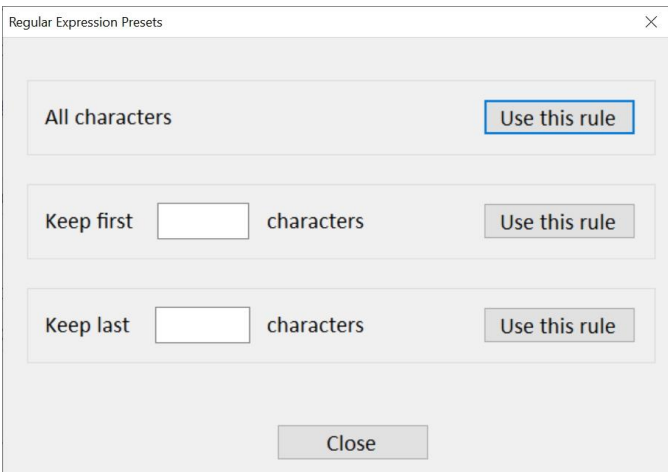
Item	Description
Prefix	User can type in this field to define the characters BEFORE the data scanned.
Suffix	User can type in this field to define the characters AFTER the data scanned.
Append Enter	The check box user can define to append an “Enter” which is followed by the characters.
Append TAB	The check box user can define to append an “TAB” which is followed by the characters.
Regex Filter	<p>Press on “Presets...” button, user can define how many characters to show after the data scanned.</p> 
Replace	User can define specific characters to be replaced with preferred characters automatically. When the characters defined in <b><u>Regex Substitution</u></b> is scanned, the data will be replaced with the one filled in <b><u>Replace with</u></b> .
Reset to default	User can remove all the set up and back to default mode.

## SDK

For users following SDK for software porting, the scanned data can also be output with the format needed.

**NOTE:**

User can download the SDK from Winmate Download center (the QR code in the cover page).

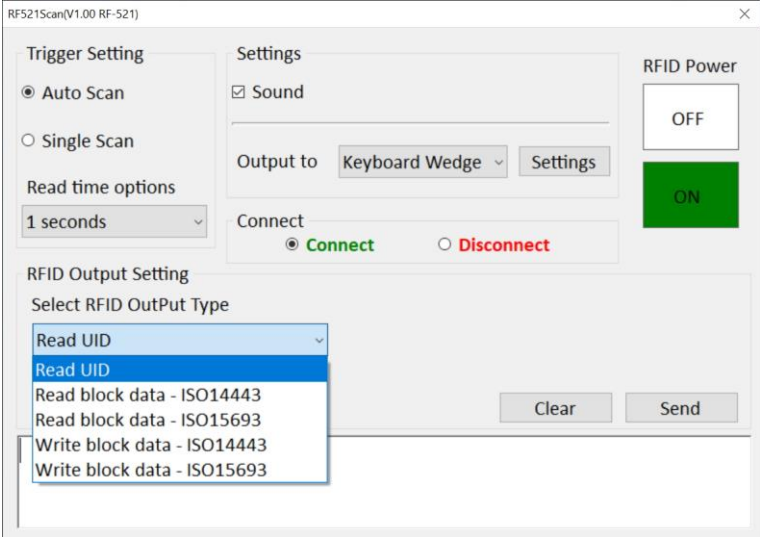

### 3.7.3 RFID Output Setting

Item	Description
Select RFID Output Type	<p>The default setting for built-in HF RFID Reader is to <b>Read UID</b>. For some applications, user might need to read or write further block data; the drop-down menu under this section can do this change.</p> 
Disconnect	<p>User can tap on the <b>Disconnect</b> button to stop the connection with built-in HF RFID reader.</p> <p>*To recover the connection, please turn off the module from setting UI and then turn on the module again.</p>

## 3.8 Power Saving



### 3.8.1 Reducing Power Consumption

Use methods below to reduce power consumption:

- Reduce LCD brightness: Press **Fn + ↓**
- Change the Power mode:
  1. Click  or  on the task tray.
  2. Move the **Power mode** slider to the left to set **Best battery life**.
- Turn off the computer when not in use. Including the WLAN or WWAN power.
- Disconnect external devices (external mouse, USB devices, etc.) when not being used.
- Use sleep when leave the computer, or shut down computer operation.
- When on battery power, do not use applications that place significant load on the CPU.
- When using screen saver, use one without 3D graphics.



To change: right-click the desktop → **Personalize** → **Lock screen** → **Screen saver settings** and click the title of the screen saver.

### 3.8.2 Configuring Power Saving Settings



1. Click  or  on the task tray.
2. Use the slider under **Power mode** and select the setting.

### 3.8.3 Customizing the Power Setting



#### *3.8.3.1 Customize Power Setting*

1. Right-click  or  on the task tray and click **Power Options**.
2. Click **Create a power plan**, click the basic plan and input the name of power plan.
3. Click **Next**.
4. Change the setting and click **Create**.

#### *3.8.3.2 Modify the Power Plan Setting*

1. Right-click  or  on the task tray and click **Power Options**.
2. Click **Change plan settings** and change the settings.
3. **Change advanced power settings** to make more detailed settings
4. Click **Save changes**.

### 3.8.3.3 Delete the Power Plan

1. Right-click  or  on the task tray and click **Power Options**.
2. Click **Change plan settings** of the power plan you wish to delete.
3. Click **Delete this plan** and click **OK** on the confirmation screen.

# Chapter 4: Network and Wireless Connections

## 4.1 Connecting LAN

**Important:**

Do not connect the telephone cable to the LAN port.

1. Turn off the computer. Do not use sleep or hibernation.
2. Open the IO cover.
3. Connect the LAN port and network system (server, HUB, etc.) using a LAN cable.
4. Turn on the computer.

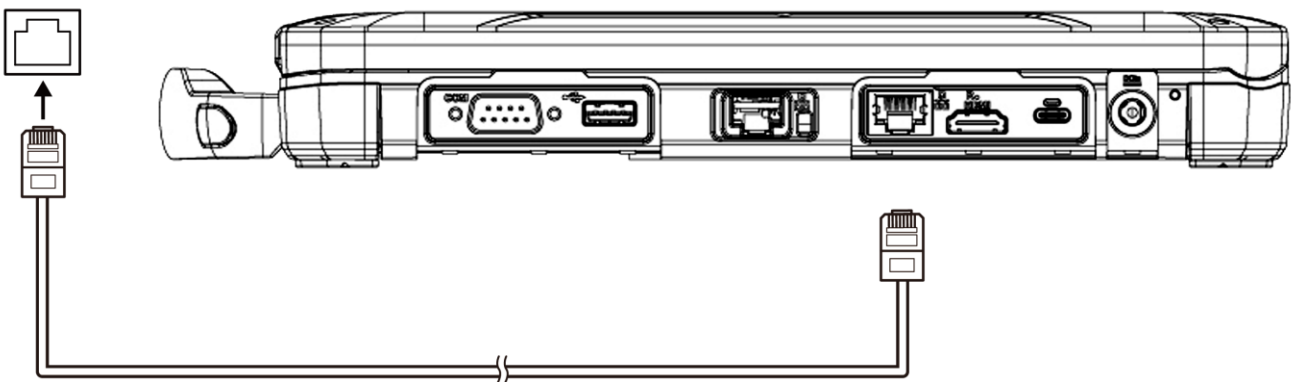

## 4.2 Disabling/Enabling Wireless Communication

Only for model with wireless LAN/ 2<sup>nd</sup> wireless WAN/ BT/ wireless WAN/ GPS on wireless WAN/ dedicated GPS.

- There are several ways of disabling and enabling wireless communication.
- Using the airplane mode.
- Turning wireless communication on/off quickly.
- Using Network & Internet settings.
- Setting **Wireless Configuration** in the **Advanced** menu of the Hottab Utility.



### 4.2.1 Using Airplane Mode

1. Click  **Start** → **Settings** → **Network & Internet** → **Airplane mode**.
2. To disable wireless communications, set Airplane mode<sup>3</sup> to **On**.
3. To enable wireless communications, set Airplane mode<sup>3</sup> to **Off**, and then:
  - Set **Cellular** to **On** (for wireless WAN).
  - Set **Wi-Fi** to **On** (for wireless LAN).
  - Set **Wi-Fi 2** to **On** (for 2<sup>nd</sup> wireless LAN).
  - Set **Bluetooth** to **On** (for BT).

### 4.2.2 Turning Wireless Communication On/Off Quickly

1. Click  on the task tray.
2. If the **Wi-Fi** feature is turn on, tap on the Wi-Fi icon to disable it.

### 4.2.3 Turning On/Off the Airplane Mode

1. Click  on the task tray.
2. Click  to turn on/off.

### 4.2.4 Using Network & Internet Settings

1. Click  on the task tray.
2. Click Network & Internet settings.
3. Click the menu **Wi-Fi**, **Cellular**, or **Airplane mode**<sup>3</sup>, and turn on/off each wireless function.

---

<sup>3</sup> Screen messages are explained in English (United States)

Depending on the language preference, some screen messages in these instructions are different from the actual screen messages. For example, Flight mode/WiFi/WiFi 2 may be displayed instead of Airplane mode/ WiFi/WiFi 2 in some language preference.

## 4.3 Connecting Wireless LAN

Only for model with wireless LAN (WLAN)/ 2<sup>nd</sup> WLAN.



### Important:





- Do not use WLAN on airplanes, in hospitals, or in other locations where WLAN signals may affect devices. Follow the instructions of airline companies and hospital, or disable the WLAN function in these locations.
- To avoid unauthorized access to the computer through WLAN, we recommend you to make security settings such as encryption before using WLAN.

Communication is established through the built-in WLAN antenna and 2<sup>nd</sup> WLAN antenna on the upper side of display. Do not block with your body or hand. When you connect the computer to a port replicator compatible with external antenna, you can switch the internal antenna to the external antenna, or vice versa. Please be notice the transmission rate will be lower when a microwave oven is used nearby.

To use WLAN, set Wireless LAN/Wireless LAN (2<sup>nd</sup>) to **Enabled** (default) in the sub-menu of **Wireless Configuration** in the **Advanced** menu of Hottab Utility.

### 4.3.1 Using the WLAN

To use the WLAN feature to connect to the network, perform the following procedure:

1. Turn the wireless LAN on by following [Chapter 4.2 Disabling/Enabling Wireless Communication](#).
2. Click  or  on the task tray.
3. <Only for model with 2<sup>nd</sup> WLAN> Click  at upper access point displayed, then select **Wi-Fi 2**.
4. Select an access point, click **Connect**.
5. Input the password key you set for the access point to recognize the computer, and click **Next**.
6. Wait for the computer to connect to the WLAN access point. When the icon on the task tray change to , the WLAN setting is complete.



### Note:

- The settings depend on the network environment. For further information, ask the system administrator or the person in charge of the network.
- If you use the stealth type WLAN access point which restricts automatic detection of the WLAN, take the following procedure to access:
  1. Click  on the tray task and click **Hidden network**.
  2. Click **Connect**, enter the necessary information, and click **Next**.
- <Only for model with 2<sup>nd</sup> WLAN>  
Using the WLAN and 2<sup>nd</sup> WLAN in the same frequency band may cause radio wave interference, resulting in reduction in the communication speed, noise occurrence or connection failure. Set and use different frequency bands between the WLAN and 2<sup>nd</sup> WLAN. Recommended settings:  
WLAN: 5 GHz  
2<sup>nd</sup> WLAN: 2.4 GHz

### 4.3.2 Using the WLAN by Hottab Utility

To use the wireless LAN feature to connect to the network, perform the following procedure:

1. Launch the  HotTab Utility application.
2. Tap on the **Devices ON/OFF** button.
3. Check the status color of the Wi-Fi icon:

Item	Status Color	Description
 <b>Wi-Fi</b>	Orange	WLAN is enabled.
	White	WLAN is disabled.

4. If the WLAN feature is disabled (white), tap on the Wi-Fi icon to enable it (orange).
5. Click the wireless network connection status icon in the Windows notification area. A list of available wireless networks is displayed.
6. Double-click a network to connect to it. Provide required authentication information if needed.
7. To check the connection status, observe wireless network connection status icon in the Windows notification area. The more bars the icon shows, the better the wireless LAN connection strength is.
8. Now wireless LAN connection is setup, try connection to the network with an internet browser such as Internet Explorer.

### 4.3.3 Enabling/Disabling WLAN Standard IEEE802.11a (802.11a)

1. Click  **Hottab Utility** → **Settings** → **Network**.
2. Click **Enable** or **Disable** for the wireless LAN IEEE802.11a.

<Only for model with 2<sup>nd</sup> WLAN> IEEE802.11a cannot be set separately for WLAN and 2<sup>nd</sup> WLAN.



**Note:**

In some countries, communication using IEEE802.11a (5GHz wireless LAN) standard is restricted by law. If IEEE802.11a is enabled or disabled while the computer is connected to an IEEE802.11b/g access point, the connection will be temporarily interrupted.

## 4.4 Wireless WAN (4G/LTE)

<Only for model with Wireless WAN (WWAN) The computer supports data connection with 4G/LTE modules and fits a Nano-SIM card. Do not use the Nano-SIM card adapter. Do not insert Nano-SIM cards on which labels or stickers are affixed. Failure to obey may result in malfunction. Communication is established through the WWAN antenna on the upper side of the display. Do not block the area with your hand or body. To use WWAN, set **Wireless WAN** to **Enabled** (default) in the sub-menu of **Wireless Configuration** in the **Advanced** menu of Hottab Utility.

If the device driver software was not installed correctly or similar message appears after resuming from sleep/hibernation or starting the computer, check:

- When communication works normally, WWAN is operating well.
- If communication fails, the device may fail to recognize. Restart the computer.



### 4.4.1 Insert a SIM card



#### Caution

Power off and unplug the laptop before installing the Nano SIM card, or the computer might be damaged by the incorrect installation behaviors.

To install the SIM card:

1. Remove the right battery, as described in section 1.6.1 Installing Battery.
2. Press the SIM-card rubber to open the SIM tray.
3. Put the SIM card on the tray and insert SIM-card all the way in. Chip/contact is facing down.
4. Put the battery back and lock the battery.

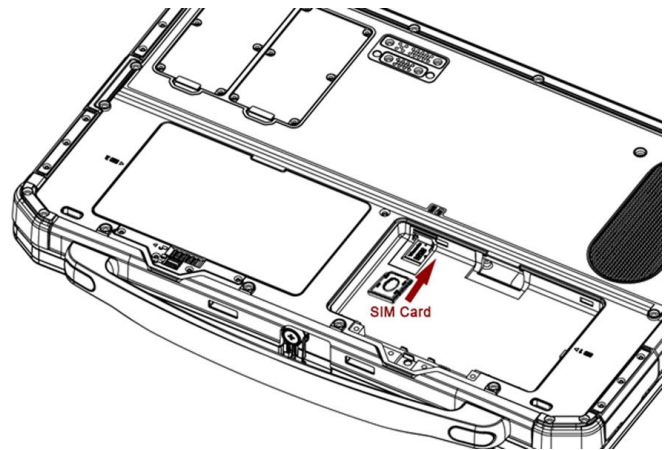
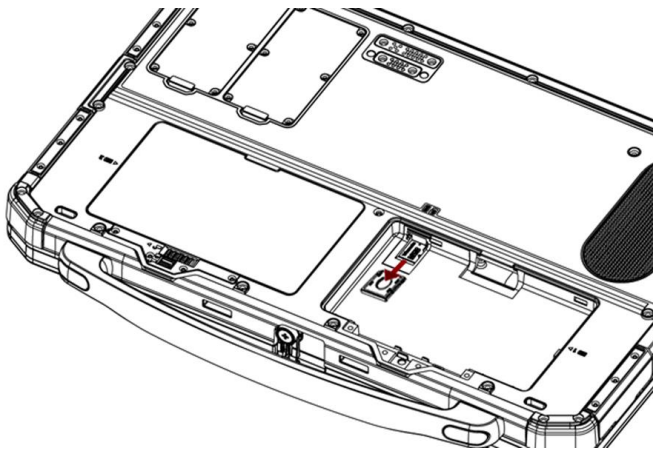

#### Important:

Do not insert the nanoSIM card upside down.

### 4.4.2 Connect/Disconnect to A Network

To connect to the network using wireless WAN:

1. Click  → **Settings** → **Network & Internet** → **Cellular**.
2. Click **Advance options**.
3. Click **Add an APN**.
4. Input detailed information such as APN, and then click **Save**.
5. Click **OK**. Internet connection is established.
6. If you are not connected to the Internet, select created APN profile, and then click **Apply**.

**Note:**

- When “Use cellular instead of Wi-Fi” is set to When Wi-Fi is poor (default), WWAN connections will be established only when there is no internet connection via WLAN.
- When using WWAN, disable the airplane mode:
  - Click  **Start** → **Settings** → **Network & Internet** → **Airplane mode**<sup>4</sup>.
  - Set Airplane mode<sup>4</sup> to **Off**:
  - Set **Cellular** to **On**.

To disconnect to a network:

1. Click  **Start** → **Settings** → **Network & Internet** → **Cellular**.
2. Click **Disconnect**.

Or, you can also click  on the task tray, and then click **Disconnect**.

### 4.4.3 Using the Wireless WAN by Hottab Utility

For tablets equipped with wireless WAN (4G LTE) card, to use the wireless WAN feature to connect to the network, perform the following procedure:

1. Launch the  HotTab Utility application.
2. Tap on the **Devices ON/OFF** button.
3. Check the status color of the WWAN icon:

Item	Status Color	Description
 <b>WWAN</b>	Orange	WWAN (4G LTE) is enabled.
	White	WWAN (4G LTE) is disabled.

4. If the WWAN feature is disabled (white), tap on the WWAN icon to enable it (orange).
5. You can check the wireless WAN connection status through the wireless network connection status icon in the Windows notification area. The more bars encompassed, the better the signal is.

## 4.5 BT Module

<Only for model with BT>

Communication is established through the BT antenna on the upper side of the display. Do not block with your body or hand. To use BT, set **BT** to **Enabled** (default) in the sub-menu of **Wireless Configuration** in the **Advanced** menu of the Hottab Utility. Turn the BT off when you uninstall the BT driver.

Please notice the transmission rate will be lower when a microwave oven is used nearby.

<sup>4</sup> Screen messages are explained in English (United States)

Depending on the language preference, some screen messages in these instructions are different from the actual screen messages. For example, Flight mode/ WiFi/WiFi 2 may be displayed instead of Airplane mode/ WiFi/WiFi 2 in some language preference.

### 4.5.1 Turning On/Off the BT Function

1. Enable the wireless communication by following [Chapter 4.2 Disabling/Enabling Wireless Communication](#).
2. Click  **Start** → **Settings** → **Network & Internet** → **Airplane mode**<sup>5</sup>. Set Airplane mode<sup>5</sup> to **Off**.
3. To turn on the BT communication, set **Bluetooth** to **On**.  
To turn off the BT communication, set **Bluetooth** to **Off**.

### 4.5.2 Using the BT feature by Hottab Utility

To enable the wireless BT feature, perform the following procedure:

1. Launch the  HotTab Utility application.
2. Tap on the **Devices ON/OFF** button.
3. Check the status color of the BT icon:

Item	Status Color	Description
 <b>BT</b>	Orange	BT is enabled.
	White	BT is disabled.

5. If the BT feature is disabled (white), tap on the BT icon to enable it (orange).
6. Click the BT icon in the Windows notification area. A contextual menu for BT is displayed.
7. To add a device, tap on Add a BT Device. Windows will search any BT device automatically.
8. Choose the BT device that user wants to connect and follow onscreen prompt to continue the pair procedure and use the BT device.

<sup>5</sup> Screen messages are explained in English (United States)

Depending on the language preference, some screen messages in these instructions are different from the actual screen messages. For example, Flight mode/WiFi/WiFi 2 may be displayed instead of Airplane mode/WiFi/WiFi 2 in some language preference.

### 4.5.3 Check BT Communication Status

Click  **Start** → **Settings** → **Devices** → **Bluetooth & other devices**. Or,

Click  on the task tray, and then click  **Bluetooth Devices** → **Show Bluetooth Devices** to check the communication status.

## 4.6 GPS

Communication is established through the GPS antenna on the upper side of the display. Do not block with your body or hand. When the u-blox Virtual COM Port is included in Ports (COM & LPT) under Device Manager, the Sierra Wireless SnapdragonTMX16LTE-A NMEA Port cannot be used.

To enable the wireless GPS feature, perform the following procedure:

1. Launch the  HotTab Utility application.
2. Tap on the **Devices ON/OFF** button.
3. Check the status color of the GPS icon:

Item	Status Color	Description
 <b>GPS</b>	Orange	GPS is enabled.
	White	GPS is disabled.

4. If the GPS feature is disabled (white), tap on the GPS icon to enable it (orange). Now the GPS feature is ready to be used with an application utilizing the GPS.

# Chapter 5: Connectors

## 5.1 External Display

You can switch the output destination to an external display using the HDMI port or USB port. To switch the display mode:

1. Click  **Start** → **Settings** → **System** → **Display**.
2. Select the item under Multiple Displays.





### Note:

- After switching the display mode, the display resolution may change.
- Resuming computer from sleep or hibernation, or restarting the computer may alter the output destination than the previously selected.
- When you change the display after Windows starts up, do not press any key until switching is complete.
- Do not connect or remove the external display during sleep or hibernation.
- It may take some time to switch between displays depending on the display used.
- When you use the external display only, set the suitable number of colors, resolution, or refresh rate separately from then you use the internal LCD only or when you use the simultaneous display.
- When connecting an external display that does not conform to the Plug & Play standards, select the display driver accordingly in the following menu, or use the driver disc supplied with the monitor.

1. Click  **Start** → **Settings** → **System** → **Display**.
2. Under Multiple displays, click **Advanced display settings** → **Display adapter properties for Display** → **Monitor** → **Properties** → **Driver** → **Update Driver**.



### Important:

- Before disconnecting the external display, switch to the internal LCD by pressing  key + **P**. Otherwise the displayed image quality may become different after disconnection. In this case, press pressing  key + **P** to reset the image quality or reset the computer.
- It may not be possible to use the extended desktop with some software applications.
- When you click the maximize button, the window is displayed on one of the displays. You cannot move the maximized window to the other display.

## 5.2 USB Devices

*To connect the USB device*



Open the I/O cover and connect the USB device to the USB3.0 (Type-A) or USB3.0 (Type-C) on the computer.



### Note:

- You may need to install the driver for the USB drive. Follow the on-screen instructions or refer to the instruction manual of the USB device.
- You may need to install the driver again when connecting the device to another port.
- When the USB device is removed and then inserted while the computer is on,  may appear in the Device Manager and the device may not be correctly recognized. Remove and connect the device again or restart the computer.
- When a USB device is connected, sleep or hibernation may not function normally. If the computer does not start up normally, remove the USB device and restart the computer.
- When the USB device is connected, power consumption increases. Remove the USB device when it is not in use, especially when operating by battery power.
- If the computer enters sleep while a USB keyboard or mouse is connected, touching the USB devices will resume the computer.

*To remove the USB device*

1. Click  on the task tray, then click .
2. Select the USB device.



### Note:

These steps are not necessary when:

- Removing the device after turning off the computer.
- The device does not appear after step no.2.
-  is not displayed.

3. Remove the USB device.

## 5.3 COM Port Definition

L156 Series Rugged Laptop uses Hottab utility for built-in peripherals control. All the COM port numbers have been defined in the OS image coming with the package.

COM Port	Device	
COM1	FTDI	RS232 port
COM3	FTDI	RFID
COM4	Standard Serial over BT link	
COM5	4G	COMPORT
COM6	4G	COMPORT
COM7	4G	Modems
COM8	4G	COMPORT
COM9	GPS	COMPORT

For some special applications, user might re-install OS and lose the COM port settings. To make sure the features work properly with Hottab utility, please follow the procedure below to re-define the COM port numbers:

1. Go to **Device Manager**, right click on the COM number need to be changed, and tap on **Properties** to open the setting page.

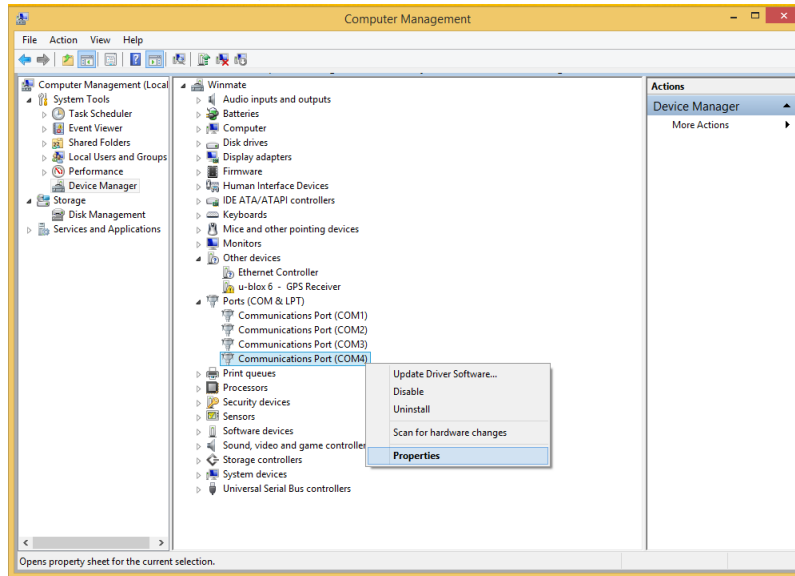

2. Tap on **Port Setting** tab and click on **Advanced** button.

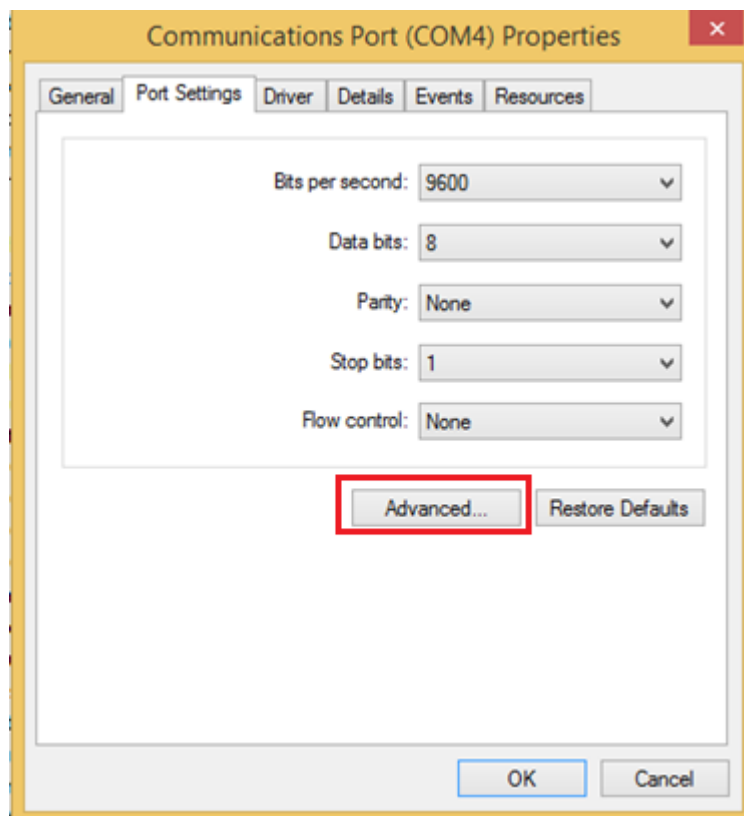

3. Tap on the dropdown list and choose the correct COM Port Number (refer to the COM Port Definition Table), and click **OK**.

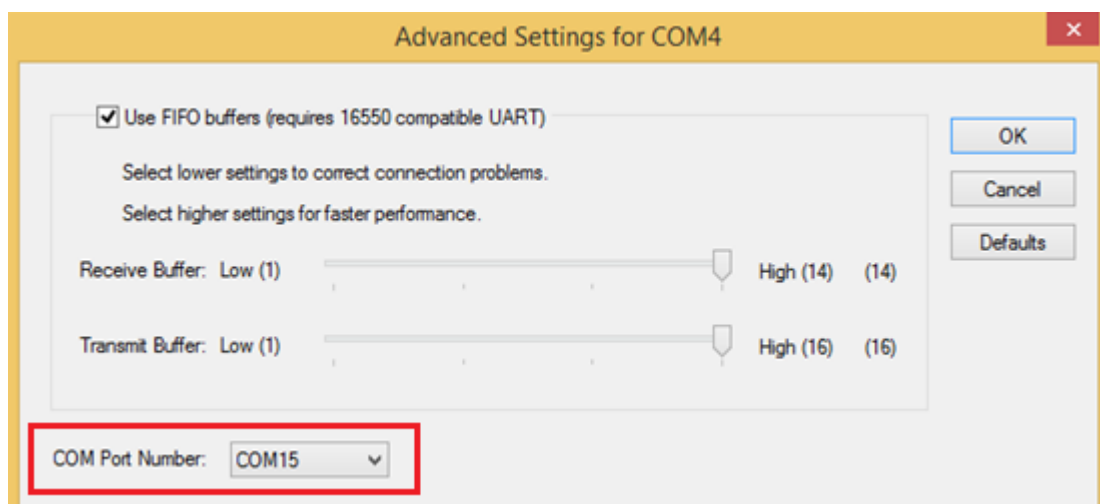

4. Double check **Device Manager** to make sure the COM Port number has been re-defined successfully, and then restart the system.



# Chapter 6: Handling and Maintenance

## 6.1 Operation environment

- Place the computer on a flat stable surface not subject to shock, vibration and danger of dropping. Do not place the computer upright or turn it over. If the computer is exposed to an extreme strong impact, it may become damaged.
- Optimal operating condition

### Temperature

Operation: -20 °C to 60 °C (-4 °F to 140 °F)

Storage: -30 °C to 70 °C (-22 °F to 158 °F)

### Humidity

Operation: 10% to 90% RH (No condensation)

Storage: 10% to 90% RH (No condensation)

Even within the above ranges, operation for a long time in extreme conditions, smoking nearby, or where oil is used, or dirty area will result in the product deterioration and will shorten the product life. If the computer is wet in temperature of 0 °C (32°F) or below, freeze damage may occur. Make sure to dry off the computer before use.

- To avoid damage, do not place the computer near electronic equipment (image distortion or noise may occur) and in extreme high or low temperature.
- As the computer can become hot during operation, keep it away from items that are sensitive to heat.

## 6.2 Handling Cautions

This computer is design to minimize shock to parts such as the LCD, the flash memory drive, and equipped with a drip-proof keyboard. But no warranty is provided against any trouble caused by shock. Be extremely careful when handling the computer.

- When carrying the computer:
  - Turn off the computer.
  - Remove all external devices, cables, and other protruding objects.
  - Do not drop or hit the computer against solid objects.
  - Do not leave the display open.
  - Do not grip the display part.
- Do not put anything between the display and keyboard.
- When boarding an airplane, follow the airline's instructions.
- When carrying a spare battery, put it in a plastic bag to protect its terminal.

- Be careful not to get injured by dropping or getting hit when carrying the computer.
- Do not place any object on display's surface and do not press down strongly with sharp-pointed or hard objects that may leave marks.
- Avoid any harmful substances such as oil into the touchpad, it may cause malfunction.
- Do not put too much pressure when operating the screen, only a light touch is required.
- Do not use the screen when dust or dirt is on the screen.

### **6.2.1 Handling the Screen**

- Do not apply strong pressure to the screen outside of the LCD display.
- Do not apply excessive force to the screen.
- Operations response may be slower in low temperature environments.
- If the pointer jumps to a location other than where the screen was touched, or if the LCD resolution changes, recalibrate the screen. Refer to *2.3.3 Calibrating the Screen*.

### **6.2.2 Using Peripheral Devices**

Carefully read the instruction manuals of the respective peripheral devices.

- Use the peripheral devices conforming to the computer's specifications.
- Connect to the connectors in the correct direction.
- Do not insert by force. Check the connector's shape, direction, alignment or pins, etc. before inserting.
- If screws are included, fasten them securely.
- Remove the cables when you carry the computer. Do not pull the cables by force.

### **6.2.3 When Battery Indicator Does Not Light On**

The battery indicator may not light on even if the AC adaptor and the battery pack are correctly connected to the computer. This may be due to the AC adaptor's protection function. In this case, unplug the AC cord and wait more than 1 minute before reconnecting the AC cord.

## 6.3 Maintenance

### 6.3.1 Cleaning the LCD Panel

The screen is specially treated to prevent dirt from adhering to the surface. Also, to improve the outdoor visibility of the display, an anti-glare film has been added. When removing the dirt on the screen surface, use only an approved soft cloth in order to avoid scratches and peeling of the coating.

- Use only the dry soft cloth.
- Turn the computer off before cleaning.
- Lightly wipe the foreign particles and dust on the LCD display, fingerprint reader, etc. with the soft cloth.

### 6.3.2 Cleaning Other Areas

- Do not use benzene, thinner, or rubbing alcohol since it may affect the surface causing discoloration, etc.
- Do not use commercially available household cleaners and cosmetics, as they may contain components harmful to the surface.
- Do not apply water and detergent directly to the computer, since liquid may enter inside the computer and cause malfunction or damage.
- Use a soft, dry cloth to wipe droplets of water from the surface. Don't use a microwave to dry the unit to avoid malfunction or damage.

## 6.4 Security Measures

### 6.4.1 Setting the Windows Password



#### **Important:**

- Remember your password.
- Check the status of NumLock and Caps Lock when setting and inputting password.

The Windows password will be applied when you sign in to Windows, or resume the computer from the Lock screen.

1. Click  **Start** → **Settings** → **Accounts** → **Sign-in options**.
2. Click **Add** under **Password**.

Set the key entry to English “ENG” and enter characters. The keyboard layout can be added and changed:

1. Click  **Start** → **Settings** → **Time & Language** → **Language**.
2. Click a language and click **Options**.
3. Click **Add a keyboard** and choose a keyboard from the list.

## **6.4.2 Internet and Online Security**

### ***6.4.2.1 Protecting Your Computer***

It is vital to protect your computer from viruses and attacks over the internet. A comprehensive internet security program is offered when you first start your computer. You should activate this protection as soon as possible, certainly before you connect to the internet.

### ***6.4.2.2 Choose an Internet Service Provider***

Using the internet has become a natural part of daily computing. Just a few simple steps can connect you to a vast collection of knowledge and communication tools. To accomplish these steps you should first select an Internet Service Provider (ISP), which supplies the connection between your computer and the internet. You should research the ISPs available in your region, not forgetting to talk to friends and family about their experiences or to check reviews and consumer reports. The ISP you select will provide instructions on how to connect to the internet (you may need additional software or a special ‘box’ that connects to your phone line).

#### ***Connection types***

Depending on your computer model, your location and your communication needs, you have several ways to connect to the internet.

#### ***Dial-up***

Some computers include a telephone dial-up (‘modem’) connector. This allows you to connect to the internet using your telephone line. With a dial-up connection, you cannot use the modem and the telephone simultaneously on a single phone line. This type of connection is recommended only if you have limited use of the internet as the connection speed is low and connection time is typically charged per hour.

#### ***DSL (e.g. ADSL)***

DSL (Digital Subscriber Line) is an ‘always-on’ connection that runs over the phone line. As DSL and phone do not use the same frequencies, you can use your telephone at the same time you are connected to the internet (this requires a ‘micro-filter’ on each telephone socket to avoid interference). To be eligible for DSL, you must be located near an DSL-equipped phone exchange (service is sometimes unavailable in rural areas). Connection speeds vary depending on your location, but DSL generally provides very fast and reliable internet connection. As the connection is always-on, it is generally charged at fixed monthly rates.

**Note:**

A DSL connection requires an appropriate modem. A modem is usually provided by the ISP when you register. Many of these modems include an 'router' that provides network and WLAN access.

**Cable**

A cable connection provides fast and always-on internet service via a cable television line. This service is generally available in large cities. You can use your telephone and watch cable TV at the same time you are connected to the internet.

**Cellular**

A cellular connection allows you to use cellular networks (such as those used by a mobile phone) to connect to the internet while away from home. The socket for a SIM card may be built in to your computer, or may require an external device, such as a USB modem or even an appropriately equipped mobile phone.

**Note:**

If your computer includes a SIM card slot, you require a compatible SIM card and a contract with a cellular provider.

Before using the cellular features, check with your service provider to see if any additional charges will be incurred, especially roaming charges.

**6.4.2.3 Network Connections**

A LAN (Local Area Network) is a group of computers (for example, within an office building or home) that share a common communications line and resources. When you set up a network, you can share files, peripheral devices (such as a printer) and an internet connection. You can set up a LAN using wired technologies (such as Ethernet) or wireless technologies (such as WLAN or BT).

**Wireless networks**

A wireless LAN or WLAN is a wireless local area network, which may link two or more computers without using wires. Setting up a wireless network is easy and allows you to share files, peripheral devices and an internet connection.

**Components of a wireless LAN**

To set up your Wireless network at home you need to have the following:

- Access point (router)

Access points (routers) are two-way transceivers that broadcast data into the surrounding environment. Access points act as a mediator between wired and wireless network. Most routers have a built-in DSL modem that will allow you access to a high speed DSL internet connection. The ISP (Internet Service Provider) you have chosen normally supplies a modem/router with the subscription to their services. Read carefully the documentation supplied with your Access point/router for detailed setup instructions.

- Network cable (RJ45)

A network cable (also called RJ45 cable) is used to connect the host computer to the access point (see illustration below); this type of cable may also be used to connect peripheral devices to the access point.

- Wireless adapter

Most computers feature a wireless module and WLAN button that turns the network connection on or off. You may also turn your wireless network on or off, or control what is shared over the network with the network management options. Search 'HomeGroup' and then click on **HomeGroup**.



### **Warning!**

Using wireless devices while flying in aircraft may be prohibited. Switch off all devices before boarding an aircraft; they may be dangerous to the operation of the aircraft, disrupt communications, and even be illegal. After take-off, ask the cabin crew if you may enable WLAN.

#### **6.4.2.4 Surf the Net!**

To surf the internet, you need a program called an internet browser. Microsoft Edge provides an easy and secure web browsing experience. As soon as you have your internet access installed and you are connected, from the Start Menu, click the Microsoft Edge tile or the icon located in the taskbar and take your internet experience to a new level!

#### **6.4.2.5 Internet Security Software**

##### *Staying ahead of cybercriminals*

Stay ahead of hackers and cybercriminals by understanding the tactics they use to access your private data.

##### *Ensure your software is up to date*

Cybercriminals rely heavily upon software or platform vulnerabilities, as they are the easiest way to sneak malware into a user's device unnoticed, sometimes with little action on the user's part. Immediately after a software manufacturer announces an update, hackers are ready with malware that can breach holes in the software that would have been patched if the update was installed.

**How to stay safe:** Perform any and all software updates as soon as they are available.

##### *Keep a lookout for fake or phishing emails*

Beware of emails that appear to be from a friend or business colleague that you know but seem a little odd. Maybe they didn't capitalize your name or there are misspellings. The email might be from cybercriminals who are trying to fool you into sending them your credit card number, social security number, or logging into a fake bank website that looks like yours but really isn't.

**How to stay safe:** Use a strong antispam filter. If an email looks strange, don't click on anything and delete it immediately. Instead manually launch a browser and type in your bank's website address and log-in yourself.

### *Don't be fooled if someone calls your phone*

A tech support scam is a form of online fraud where people call you on the phone saying they're Technical Support from a trusted company. The main motive behind these scams is to extort money from the victim. Cybercriminals can also install malware such as keylogging software or backdoor Trojans in order to gain access to personal information.

**How to stay safe:** Don't fall for phone calls that tell you your software or computer isn't working. Never give your personal information like social security or credit card numbers to someone that you don't know over the phone.

### *Common threats cybercriminals use*

Now you know a few very common ways cybercriminals try to sneak onto your device or trick you into providing private information to them directly. Here are a few of the types of malware they like to deploy once they've got into a device and what to do if you're ever infected.

### *Ransomware*

A form of malware that will encrypt personal data files on your computer and attached devices. Encryption converts files into another format, that can only be opened with a specific decryption key. Once the ransomware installs itself, it will display a warning message that the computer is now locked. The user is given a specific amount of money to pay as a "fine" and a timeframe in which to pay. Even if paid, the criminal might choose to not unencrypt the files anyway!

**What to do if you're infected:** Avoid getting infected in the first place by staying protected with internet security software. Also, perform regular backups of all your data either online or to a separate external hard drive that is only attached to your computer while performing the backup. Ransomware has been known to lock access to external hard drives attached to the computer.

If you are infected with ransomware, think twice before you pay the ransom. There is no guarantee the cybercriminal will unlock your files and you'll be funding them to prey upon another innocent victim.

### *Botnets*

A botnet is a string of infected, connected computers coordinated together to perform a task. Botnets gain access to your machine through some piece of malicious coding. Once the software is downloaded, the botnet will now contact its master computer and let it know that everything is ready to go. Now your computer, phone, tablet, or IoT device is entirely under the control of the person who created the botnet. Most people who are infected with botnets aren't even aware that their computer's security has become compromised!

**What to do if you're infected:** If you're infected you probably don't realize it as bots are notoriously quiet. Your Internet Service Provider might send you a notification alerting you that they found a threat on your network and that you need to remove the bot. If you have a bot, use internet security software to scan all of your devices.

### *Viruses/Malware*

"Virus" is the commonplace word for all malicious software programs for years now; however, a virus is just one type of malicious threat. A virus is classified as a self-replicating piece of malicious code that travels by inserting itself into files or programs.

**What to do if you're infected:** Take steps to avoid infection by staying protected with internet security software.

### *Take special precautions when using public WLAN*

Public WLAN is available just about everywhere, from the local coffee shop to the hotels and airports you visit while traveling. While public WLAN has made our lives a little easier, it also poses security risks to the personal information available on our laptops and smartphones. A virtual private network (VPN) gives you online privacy and anonymity by creating a private network from a public internet connection. VPNs mask your internet protocol (IP) address so your online actions are virtually untraceable as well as secure. One of the biggest security risks on public WLAN are man-in-the-middle attacks (MITM). These attacks are akin to eavesdropping. Data is sent from point A (computer) to point B (server/website), and an attacker can get in between these transmissions. They then set up tools programmed to "listen in" on transmissions, intercept data that is specifically targeted as valuable, and capture the data, such as your login credentials and passwords.

Use a virtual private network (VPN) to ensure your privacy and anonymity are protected when you use public WLAN. VPN services can encrypt all the data that you send and receive while using a public WLAN hotspot, securing your information from hackers and other users of the same connection.

### *For more tips on how to stay safe*

Good security habits can reduce your exposure to online crime. By adopting a few basic behaviors, you can make big strides in reducing cybercrime risk:

- Protect your accounts with strong, unique passwords that use a combination of at least 10 uppercase and lowercase letters, symbols and numbers.
- Don't click on random links or open unsolicited messages and attachments-particularly from people you don't know.
- Don't access any personal information or social media accounts over unprotected WLAN networks.
- Use security software on your devices to help protect yourself from the latest threats.

### *Windows Updates*

If you have an active internet connection, Windows can check for important updates for your computer and install them automatically. These updates include security patches and program updates that can improve your computing experience and help protect your computer against new viruses and attacks.



*How do I know when my computer is at risk?*

If the Action Center reports an alert, or if your computer behaves erratically, crashes unexpectedly or if some of your programs do not work correctly, your computer may be infected by malicious software. However, do not blame every computer problem on a virus! If you suspect your computer is infected, the first thing to do is update, if you have not already done so, and run your antivirus and anti-spyware software.

### **6.4.3 Other Security Measure**

- **About Secure Boot**

Secure Boot is a function that protects your computer by prohibiting Operating system other than those permitted under factory default conditions from being executed during startup. When performing **Clear Secure Boot Keys** to use Secure Boot.

- Using the function of Microsoft\_DeviceGuard/CredencialGuard\*: Select **Install default Secure Boot keys (Device Guard Ready)**.
- Without the function of Microsoft\_DeviceGuard/CredencialGuard: Select **Install default Secure Boot keys**.

- **About TPM**

<Only for model that supports TPM> Trusted Platform Module, TPM is a security chip aimed at high level cryptographic processing and secure storage of encryption keys. The TPM chip store encryption keys are separated form the internal disk. This will allow you to increase the security level. To use the TPM function:

1. Click  **Start** → **Windows System** → **Control Panel** → **System and Security** → **BitLocker Drive Encryption**.
2. Click **TPM Administration**.

For more information about the usage, follow the instructions by a system administrator.

- **Kensington Lock**

The computer comes with a computer security slot for a security lock. Wrap a computer security lock cable around an immovable object such as a table or handle of a locked drawer. Insert the lock into the notch and turn the key to secure the lock. Some keyless models are also available.

---

\* It is not supported by the factory OS.

- **Windows Hello**

This function is used to sign in to Windows quickly, or perform individual authentication.

<Only for model with camera with IR sensor> The face recognition for Windows Hello is supported. To use:

1. Click  **Start** → **Settings** → **Accounts** → **Sign-in options**.
2. Under the Windows Hello, click **Set up** and follow the on-screen instructions.



**Note:**

- To use Windows Hello, password and PIN for sign-in options are needed.
- During face recognition, the IR sensor camera light turns on and becomes hot. Do not touch the IR sensor section when the light is on and shortly after the light turns off.

## Chapter 7: Basic Troubleshooting

Problem	Solution
The computer does not start or boot up after pressing the power button	<ul style="list-style-type: none"> <li>• Check if power is being supplied to the computer (if your computer has a power indicator, it will be off).</li> <li>• If you are using on the battery, it may be low and unable to power the computer. Connect the AC adapter to recharge the battery pack. You may need to wait a few minutes before trying to turn your computer on again.</li> <li>• Make sure that the AC adapter is properly plugged into the computer and to the power outlet.</li> <li>• If power is being supplied to the computer, do you have a USB storage device (USB drive, CD drive or smartphone) plugged into your computer? Unplug it and press <b>Ctrl + Alt + Del</b> to restart the system.</li> </ul>
The removable battery is not charging.	<ul style="list-style-type: none"> <li>• Make sure the AC adapter is properly connected, and that the removable battery is properly inserted.</li> </ul>
Nothing appears on the screen.	<ul style="list-style-type: none"> <li>• The laptop may be in sleep mode. Press the power button to wake up the display.</li> <li>• The brightness level may be too low. Increase brightness.</li> <li>• The display device might be set to an external monitor. Press the display toggle hotkey to toggle the display back to the computer.</li> </ul>
The screen suddenly turns blank and the power indicator goes off.	<ul style="list-style-type: none"> <li>• Make sure that LED indicator is not powered off in Hottab.</li> <li>• Make sure the AC adapter is properly connected.</li> <li>• If running on battery power, the battery may be depleted, charge the battery.</li> </ul>
Wireless LAN signal quality is poor.	<ul style="list-style-type: none"> <li>• The laptop may be out of range. Move the computer closer to the access point or another wireless LAN device associated with it.</li> <li>• Check if your surroundings have interferences, such as microwave ovens, cordless phones. Move the computer away from objects causing interference.</li> </ul>
I cannot connect to another wireless LAN device.	<ul style="list-style-type: none"> <li>• Make sure that wireless LAN feature is powered on.</li> <li>• Make sure that the SSID setting is the same for every wireless LAN device in the network.</li> <li>• Restart the computer</li> <li>• Make sure the IP address or subnet mask setting is correct.</li> </ul>
The keyboard does not respond.	<ul style="list-style-type: none"> <li>• Try attaching an external keyboard to a USB port on the computer. If it works, contact your dealer or an authorized service center as the internal keyboard cable may be loose.</li> </ul>
I cannot connect to another device with BT.	<ul style="list-style-type: none"> <li>• Make sure that both devices have BT powered on (For the laptop, check Hottab to see if BT is powered</li> </ul>

Problem	Solution
	<p>on).</p> <ul style="list-style-type: none"> <li>• Make sure that the distance between the two devices is within 10 meters and there are no walls or large obstructions between the devices.</li> <li>• Make sure the both devices are powered on and configured to be discoverable.</li> <li>• Make sure that both devices are compatible.</li> </ul>
The GPS application cannot find my location.	<ul style="list-style-type: none"> <li>• Make sure that GPS is powered on in Hottab.</li> <li>• Make sure that GPS receiver and the location sensor are enabled in Control Panel.</li> <li>• The laptop may be out of coverage area. Move your computer outdoors or closer to a window.</li> <li>• Check if your surroundings have interferences, such as microwave ovens, cordless phones. Move the computer away from objects causing interference.</li> </ul>
No sound is produced.	<ul style="list-style-type: none"> <li>• Adjust volume of the computer by pressing on the volume rocker.</li> <li>• If using an external audio device, make sure that the cable is properly connected.</li> <li>• If headphones, earphones or external speakers are connected to the headphone jack on the computer, the internal speakers automatically turn off.</li> </ul>
I cannot project the computer display to another monitor.	<ul style="list-style-type: none"> <li>• Make sure the VGA driver is installed.</li> <li>• Make sure the output setting selected is correct.</li> </ul>
RFID scanner does not seem to work.	<ul style="list-style-type: none"> <li>• Make sure under Windows, the RFID hardware is set to COM 3 port.</li> </ul>
Battery leaking or swollen	<ul style="list-style-type: none"> <li>• The lithium battery used in this laptop may swell after being charged/ discharged many times, but there is no problem regarding safety.</li> <li>• Continued use in such a state may result in the battery getting jammed, so please stop using the battery, and purchase a new one.</li> </ul>

# Appendix

## Appendix A: Using Recovery Wizard to Restore Computer

L156 Series Rugged laptop has a dedicate recovery partition stored on the hard drive of the laptop to enable quick one-key recovery process. This partition occupies about 11GB of the storage space, and comes built-in to each L156 Series Rugged Laptop.



**Warning!** Before starting the recovery process, be sure to backup all user data, as all data will be lost after the recovery process.

*Follow the procedure below to enable quick one-key recovery:*

1. Plug-in the AC adapter to the laptop. Make sure the laptop stays plugged in to power source during the recovery process.
2. Power on the laptop, and when the boot screen shows up, press the **Fn1** button (Recovery Key) on the front bezel OR press **F6**.
3. The following screen shows the Recovery Wizard. Click on “Recovery” button to continue.



4. A warning message about data loss will show up. Make sure data is backed up before recovery, and click on “Yes” to continue.



- Wait till the recovery process to complete. During the recovery process, a command prompt will show up to indicate the percent of recovery process.

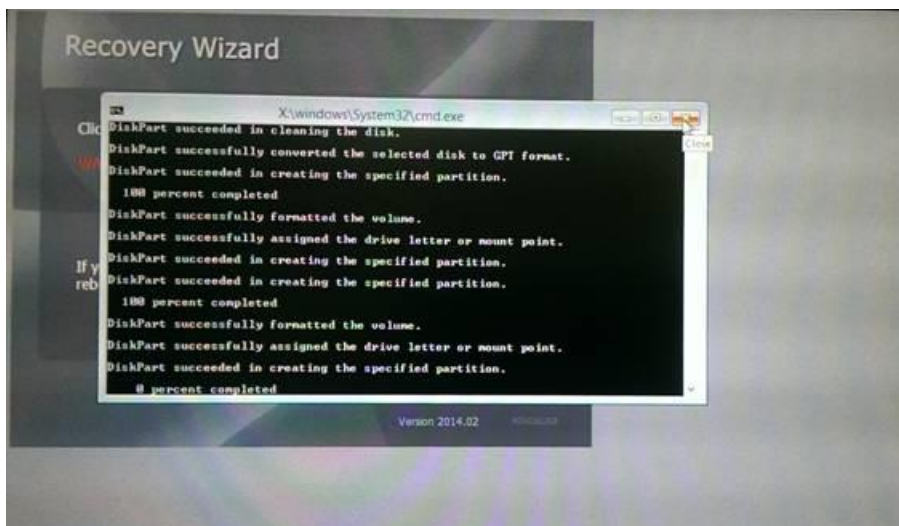

- After recovery is completed, please press any key to continue, and the computer will shut down automatically.

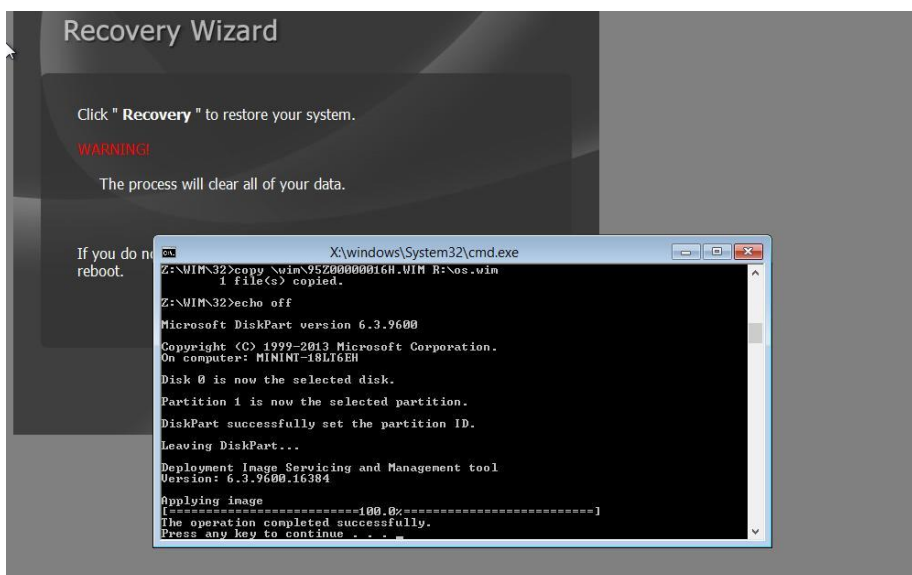

## Appendix B: Declaration of Conformity (DoC)

### FCC-B Radio Frequency Interference Statement



This equipment has been tested and found to comply with the limits for a Class B digital device, pursuant to part 15 of the FCC rules.

These limits are designed to provide reasonable protection against harmful interference in a residential installation.

This equipment generates, uses and radiates radio frequency energy, and, if not installed and used in accordance with the instructions, may cause harmful interference to radio communications. However, there is no guarantee that interference will not occur in a particular installation. If this equipment does cause harmful interference to radio or television reception, which can be determined by turning the equipment off and on, the user is encouraged to try to correct the interference by one or more of the following measures:

- Reorient or relocate the receiving antenna.
- Increase the separation between the equipment and receiver.
- Connect the equipment into an outlet on a circuit different from that to which the receiver is connected.

#### NOTE

- The changes or modifications not expressly approved by the party responsible for compliance could void the user's authority to operate the equipment.
- Shield interface cables and AC power cord, if any, must be used in order to comply with the emission limits.

### FCC Conditions

This device complies with part 15 of the FCC Rules. Operation is subject to the following two conditions:

- This device may not cause harmful interference.
- This device must accept any interference received, including interference that may cause undesired operation.

### CE Notice (European Union)

This equipment is in conformity with the requirement of the following EU legislations and harmonized standards. Product also complies with the Council directions.

Electromagnetic Compatibility Directive (2014/30/EU)



- EN55024: 2010/ A1: 2015
  - IEC61000-4-2: 2009
  - IEC61000-4-3: 2006+A1: 2007+A2: 2010
  - IEC61000-4-4: 2012
  - IEC61000-4-5: 2014
  - IEC61000-4-6: 2014
  - IEC61000-4-8: 2010
  - IEC61000-4-11: 2004
- EN55032: 2015/AC:2016
- EN61000-3-2:2014
- EN61000-3-3:2013

Low Voltage Directive (2014/35/EU)

- EN 62368-1:2014

## Battery Regulations



**European Union:** Batteries, battery packs, and accumulators should not be disposed of as unsorted household waste. Please use the public collection system to return, recycle, or treat them in compliance with the local regulations.



**Taiwan:** For better environmental protection, waste batteries should be collected separately for recycling or special disposal.

廢電池請回收

**California, USA:** The button cell battery may contain perchlorate material and requires special handling when recycled or disposed of in California.

For further information please visit: <http://www.dtsc.ca.gov/hazardouswaste/perchlorate/>

## Safety Guideline for Using Lithium Battery

Danger of explosion if battery is incorrectly replaced. Replace only with the same or equivalent type recommended by the equipment manufacturer. Discard used batteries according to manufacturer's instructions.

## WEEE Statement



**European Union:** Under the European Union ("EU") Directive on Waste Electrical and Electronic Equipment, Directive 2002/96/EC, which takes effect on August 13, 2005, products of "electrical and electronic equipment" cannot be discarded as municipal waste anymore and manufacturers of covered electronic equipment will be obligated to take back such products at the end of their useful life.

## Chemical Substances Information

In compliance with chemical substances regulations, such as the EU REACH Regulation (Regulation EC No. 1907/2006 of the European Parliament and the Council),



## **Appendix C: RoHS Statement**

### **Japan JIS C 0950 Material Declaration**

A Japanese regulatory requirement, defined by specification JIS C 0950, mandates that manufacturers provide material declarations for certain categories of electronic products offered for sale after July 1, 2006.

### **India RoHS**

This product complies with the "India E-waste (Management and Handling) Rule 2011" and prohibits use of lead, mercury, hexavalent chromium, polybrominated biphenyls or polybrominated diphenyl ethers in concentrations exceeding 0.1 weight % and 0.01 weight % for cadmium, except for the exemptions set in Schedule 2 of the Rule.

### **Turkey EEE regulation**

Conforms to the EEE Regulations of the Republic Of Turkey. Ukraine restriction of hazardous substances The equipment complies with requirements of the Technical Regulation, approved by the Resolution of Cabinet of Ministry of Ukraine as of December 3, 2008 № 1057, in terms of restrictions for the use of certain dangerous substances in electrical and electronic equipment.

### **Vietnam RoHS**

As from December 1, 2012, all products manufactured by MSI comply with Circular 30/2011/TT-BCT temporarily regulating the permitted limits for a number of hazardous substances in electronic and electric products.

## **Appendix D: Upgrade and Warranty**

Please note that certain components, such as memory modules, HDD, SSD, ODD, and BT /WLAN combo card, etc., preinstalled in the product may be upgradable or replaceable by user's request depending on the models users purchased.

For any further information on the product users purchased, please contact the local dealer. Do not attempt to upgrade or replace any component of the product if users do not understand the component location or how to assembly/disassembly, since it may cause the product to be damaged. It is recommended that you contact the authorized dealer or service center for product service information.







---

Winmate Inc.  
9F, No.111-6, Shing-De Rd., San-Chung District,  
New Taipei City 24158, Taiwan, R.O.C  
[www.winmate.com](http://www.winmate.com)

Copyright © 2024 Winmate Inc. All rights reserved.

